



**DPS 24**

---

**DIGITAL PERSONAL STUDIO**

**Version 1.6**

**AKAI**  
**professional**



**Operator's Manual**

**WARNING**

To prevent fire or shock hazard,  
do not expose this appliance to  
rain or moisture.

## Important Notice

The material in this document is copyright to AKAI professional M.I. Corp., and may not be quoted or reproduced in any form without written permission from the company.

### LIMITED SOFTWARE WARRANTY POLICY

All the software provided with, or purchased especially for, AKAI professional products has been tested for functionality. AKAI professional M.I. Corp. will make its best efforts to correct reported software defects for future releases subject to technical practicabilities.

AKAI professional M.I. Corp. makes no warranty or representation either expressed or implied with respect to the system's performance or fitness for a particular purpose.

In no event will AKAI professional M.I. Corp. be liable for direct or indirect damages arising from any defect in the software or its documentation. Further, AKAI professional M.I. Corp. will not accept any liability for any programs, sounds, audio recording or sequences stored in or used with AKAI professional products, including the cost of recovery of such data.

The warranties, remedies and disclaimers above are exclusive and take precedence over all others, oral or written, express or implied, to the extent permitted by law in the geographical area of the product's use. No employee of AKAI professional M.I. Corp., agent, distributor or employee of an agent or distributor is authorised to offer any variation from this policy.

## WARNING!!

To prevent fire or shock hazard, do not expose this appliance to rain or moisture.

1-En



THE SYMBOLS ARE RULED BY UL STANDARDS (U.S.A.)



The lightning flash with arrowhead symbol, within an equilateral triangle, is intended to alert the user to the presence of uninsulated "dangerous voltage" within the product's enclosure; that may be of sufficient magnitude to constitute a risk of electric shock to persons.



The exclamation point within an equilateral triangle is intended to alert the user to the presence of important operating and maintenance (servicing) instructions in the literature accompanying the appliance.

5B-En

## Lithium battery

This product uses a lithium battery for memory backup.

The lithium battery should only be replaced by qualified service personnel.

Improper handling may cause risk of explosion.

24A-En

**WARNING: WHEN USING ELECTRIC PRODUCTS, BASIC PRECAUTIONS SHOULD ALWAYS BE FOLLOWED, INCLUDING THE FOLLOWING:**

**WARNING**

The DPS 24MK II is designed to be used in a standard household environment.

Power requirements for electrical equipment vary from area to area. Please ensure that your DPS 24MKII meets the power requirements in your area. If in doubt, consult a qualified electrician or AKAI professional dealer.

120 VAC	@ 60 Hz for USA and Canada
220~240 VAC	@ 50 Hz for Europe
240 VAC	@ 50 Hz for Australia

**IMPORTANT SAFETY INSTRUCTIONS**

1. Read these instructions.
2. Keep these instructions.
3. Heed all warnings.
4. Follow all instructions.
5. Do not use this apparatus near water.
6. Clean only with dry cloth.
7. Do not block any ventilation openings. Install in accordance with the manufacture's instructions.
8. Do not install near any heat sources such as radiators, heat register, stoves, or other apparatus (including amplifiers) that produce heat.
9. Do not defeat the safety purpose of the polarized or grounding-type plug. A polarized plug has two blades with one wider than the other. A grounding type plug has two blades and a third grounding prong. The wide blade or the third prong are provided for your safety. If the provided plug does not fit into your outlet, consult an electrician for replacement of the obsolete outlet.
10. Protect the power cord from being walked on or pinched particularly at plugs, convenience receptacles, and the point where they exit from the apparatus.
11. Only use attachments/accessories specified by the manufacturer.
12. Use only with the cart, stand, tripod, bracket, or table specified by the manufacturer, or sold with the apparatus. When a cart is used, use caution when moving the cart/apparatus combination to avoid injury from tip-over.

**PORTABLE CART WARNING**



**S3125A**

13. Unplug this apparatus during lightning storms or when unused for long periods of time.
14. Refer all servicing to qualified service personnel. Servicing is required when the apparatus has been damaged in any way, such as power-supply cord or plug is damaged, liquid has been spilled or objects have fallen into the apparatus, the apparatus has been exposed to rain or moisture, does not operate normally, or has been dropped.
15. Do not expose this apparatus to dripping or splashing and ensure that no objects filled with liquids, such as vases, are placed on the apparatus.

For U.K. customers only

**WARNING**  
**THIS APPARATUS MUST BE EARTHED**  
**IMPORTANT**

This equipment is fitted with an approved non-rewireable UK mains plug.

To change the fuse in this type of plug proceed as follows:

- 1) Remove the fuse cover and old fuse.
- 2) Fit a new fuse which should be a BS1362 5 Amp A.S.T.A or BSI approved type.
- 3) Refit the fuse cover.

If the AC mains plug fitted to the lead supplied with this equipment is not suitable for your type of AC outlet sockets, it should be changed to an AC mains lead, complete with moulded plug, to the appropriate type. If this is not possible, the plug should be cut off and a correct one fitted to suit the AC outlet. This should be fused at 5 Amps.

If a plug without a fuse is used, the fuse at the distribution board should NOT BE GREATER than 5 Amp.

PLEASE NOTE: THE SEVERED PLUG MUST BE DESTROYED TO AVOID A POSSIBLE SHOCK HAZARD SHOULD IT BE INSERTED INTO A 13 AMP SOCKET ELSEWHERE.

The wires in this mains lead are coloured in accordance with the following code:

<b>GREEN and YELLOW</b>	— Earth
<b>BLUE</b>	— Neutral
<b>BROWN</b>	— Live

As the colours of the wires in the mains lead of this apparatus may not correspond with the coloured markings identifying the terminals in your plug, please proceed as follows:

The wire which is coloured GREEN and YELLOW must be connected to the terminal which is marked with the letter E or with the safety earth symbol  $\perp$  or coloured GREEN or coloured GREEN and YELLOW.

The wire which is coloured BLUE must be connected to the terminal which is marked with the letter N or coloured BLACK.

The wire which is coloured BROWN must be connected to the terminal which is marked with the letter L or coloured RED.

**THIS APPARATUS MUST BE EARTHED**

Ensure that all the terminals are securely tightened and no loose strands of wire exist.

Before replacing the plug cover, make certain the cord grip is clamped over the outer sheath of the lead and not simply over the wires.

6D-En

**FCC WARNING**

This equipment has been tested and found to comply with the limits for a Class B digital device pursuant to Part 15 of the FCC rules. These limits are designed to provide reasonable protection against harmful interference in a residential installation. This equipment generates, uses, and can radiate radio frequency energy and, if not installed and used in accordance with the instructions, may cause harmful interference to radio communications. However, there is no guarantee that interference will not occur in a particular installation. If this equipment does cause harmful interference to radio or television reception, which can be determined by turning the equipment off and on, the user is encouraged to try to correct the interference by one or more of the following measures:

- Reorient or relocate the receiving antenna.
- Increase the separation between the equipment and receiver.
- Connect the equipment into an outlet on a circuit different from that to which the receiver is connected.
- Consult the dealer or an experienced radio/TV technician for help.

21B-En

**AVIS POUR LES ACHETEURS CANADIENS DU DPS24**

Le présent appareil numérique n'émet pas de bruits radioélectriques dépassant les limites applicables aux appareils numériques de la Class B prescrites dans le Règlement sur le brouillage radioélectrique édicté par le ministère des Communications du Canada.

27-F

This digital apparatus does not exceed the Class B limits for radio noise emissions from digital apparatus set out in the Radio Interference Regulations of the Canadian Department of Communications.

27-En

**VENTILATION**

Do not prevent the unit's ventilation, especially by placing the unit on soft carpet, in a narrow space, or by placing objects on the unit's chassis—top, side, or rear panels. Always keep the unit's chassis at least 10 centimeters from any other objects.

31C-En

CHANGES OR MODIFICATIONS NOT EXPRESSLY APPROVED BY THE MANUFACTURER FOR COMPLIANCE COULD VOID THE USER'S AUTHORITY TO OPERATE THE EQUIPMENT.

32-En

**COPYRIGHT NOTICE**

The AKAI professional DPS24 is a computer-based device, and as such contains and uses software in ROMs. This software, and all related documentation, including this Operator's Manual, contain proprietary information which is protected by copyright laws. All rights are reserved. No part of the software or its documentation may be copied, transferred or modified. You may not modify, adapt, translate, lease, distribute, resell for profit or create derivative works based on the software and its related documentation or any part thereof without prior written consent from AKAI professional M.I. Corp., Yokohama, Japan.

---

# Table of Contents

---

<b>INTRODUCTION</b> .....	<b>1</b>
<b>DPS24 STRUCTURE</b> .....	<b>2</b>
<b>REAR PANEL</b> .....	<b>4</b>
<b>FRONT PANEL</b> .....	<b>7</b>
<b>TOP PANEL</b> .....	<b>8</b>
GETTING AROUND THE DPS24 .....	8
ILLUMINATED KEYS .....	8
INPUTS .....	9
RECORD/EDIT SELECT KEYS .....	10
L/R AND GROUP ASSIGN KEYS .....	11
SUB-GROUPING CHANNELS TO THE L/R MIX .....	12
Q-STRIP FUNCTION KEYS/CHANNEL ENCODERS .....	13
CHANNEL ENCODERS .....	13
FADER FLIP .....	14
Q-CHANNEL SELECT/Q-CHANNEL ENCODERS .....	15
Q-STRIP/Q-CHANNEL ENCODERS .....	17
FADERS/FADER BANKS .....	18
MASTER SECTION .....	20
MONITOR SECTION .....	21
LCD 'POD' .....	23
LCD LAYOUT .....	24
SOFT KEYS .....	24
PROJECT INFO BAR .....	24
SAVE INDICATOR .....	25
PROJECT OVERVIEW .....	26
WAVEFORM GENERATION INDICATOR .....	26
METER BRIDGE .....	26
Q-LINK CONTROLS .....	27
MOVING AROUND THE LCD .....	28
NAMING .....	30
PROMPTS .....	31
MAIN CONTROL SECTION .....	32
MIX SCENE KEYS .....	35
STORING A MIX SCENE .....	36
RECALLING A MIX SCENE .....	37
RESET MIXER .....	38
INITIAL SCENE .....	39

TRANSPORT KEYS .....	40
EDIT PLAY KEYS .....	41
AUTOLOCATOR .....	42
USING THE AUTOLOCATOR .....	43
QUICK LOCATE KEYS .....	45
GOTO NEXT / PREV CUE .....	45
LOCATE TO TIME .....	46
JOG/SHUTTLE WHEEL .....	47
IN/OUT KEYS .....	47
<b>POWERING UP THE DPS24 .....</b>	<b>48</b>
<b>DPS24 MODES .....</b>	<b>49</b>
<b>MAIN SCREEN .....</b>	<b>50</b>
<b>GRID .....</b>	<b>51</b>
<b>EDIT MODE .....</b>	<b>52</b>
EDITING AND AUTOMATION .....	56
COPY .....	57
CUT .....	58
ERASE .....	58
INSERT .....	59
PASTE .....	60
MOVE .....	61
WAV/AIFF IMPORT .....	63
IMPORTING MULTIPLE WAV FILES TO MULTIPLE TRACKS .....	68
WAV/AIFF FILES EXPORT .....	71
<b>DSP MODE .....</b>	<b>76</b>
TIMESTRETCH .....	77
PITCH SHIFT .....	79
BPM .....	80
VARI-SPEED .....	80
REVERSE .....	81
NORMALISE .....	82
RESAMPLE .....	82
<b>MIXER MODE .....</b>	<b>84</b>
MIXVIEW .....	86
CHANNEL .....	87
CHANNEL DYNAMICS PROCESSOR .....	92
EQ / COMPRESSOR / GATE PRESET LIBRARIES .....	94
EQ AND DYNAMICS SNAPSHOTS .....	97
STEREO CHANNELS .....	100

SOLO SETUP .....	101
USING SOLO .....	104
FX/AUX SETUP .....	105
TALKBACK TO STUDIO OUT .....	106
<b>PATCH MODE .....</b>	<b>107</b>
SOURCE .....	107
OUTPUTS .....	109
GROUPS .....	110
L/R .....	111
PATCH PRESETS .....	112
<b>AUTOMATION .....</b>	<b>113</b>
ABOUT THE AUTOMATION .....	115
RECORD SAFE .....	117
TRIM FADERS .....	118
CLEAR AUTOMATION .....	120
AUTOMATED SCENE AND SNAPSHOT RECALL .....	121
USING AUTOMATED SCENE/SNAPSHOT RECALL .....	122
NOTES REGARDING AUTOMATED SCENE RECALL .....	123
AUTOMATION EVENT EDITOR .....	125
EDITING EVENTS .....	126
<b>EFFECTS MODE .....</b>	<b>132</b>
EDITING EFFECTS .....	129
STORING EDITED EFFECTS .....	129
EFFECTS LIBRARY .....	130
FX LIBRARY FACTORY PRESETS .....	131
FX PARAMETERS .....	132
REVERB .....	132
DELAY .....	134
COMBINED .....	137
CHORUS .....	138
FLANGER .....	139
PHASER .....	140
ROTARY SPEAKER / PAN .....	141
PITCH SHIFT / WAH .....	142
EQ / ENHANCER / DISTORTION .....	143
DYNAMICS .....	144
PITCH CORRECTOR .....	146
FX SNAPSHOTS .....	148
EFFECTS SEND/RETURN LEVELS .....	150
SETTING UP MULTI-EFFECTS .....	150
RECORDING EFFECTS .....	150



---

ADDING EFFECTS TO A CONTROL ROOM MONITOR MIX .....	151
ADDING EFFECTS TO A FOLDBACK MIX .....	151
<b>PROJECT MODE .....</b>	<b>152</b>
LOADING PROJECTS .....	152
CREATING NEW PROJECTS .....	152
RECORD / PLAYBACK FROM EXTERNAL SCSI DISK DRIVES .....	154
NOTES ABOUT USING EXTERNAL DRIVES FOR RECORD/PLAYBACK ...	155
MANAGING PROJECTS .....	156
DISK COPY .....	157
PROJECT COPY VIA USB .....	158
BACKING UP PROJECTS .....	158
BACKING UP FROM EXTERNAL HARD DRIVES .....	159
COPY/BACKUP/RESTORE USER PRESETS .....	159
RESTORING PROJECTS .....	160
RESTORING TO EXTERNAL DRIVES .....	160
<b>VIRTUAL TRACKS .....</b>	<b>161</b>
UTILS .....	162
USING THE VIRTUAL TRACKS .....	163
OPTIONS .....	165

<b>SETUP MODE</b> .....	<b>166</b>
SAMPLE RATE .....	166
DIGITAL SYNC .....	167
T/C RATE .....	167
TIME SYNC .....	167
BIT DEPTH .....	168
MMC SETUP .....	169
TEMPO MAPS .....	170
PREFERENCES .....	172
PLAY TO .....	172
PLAY FROM .....	172
METRONOME .....	172
FOOTSWITCH .....	172
24-TRACK RECORD .....	173
PEAK HOLD TIME .....	173
WAVEFORM GENERATION .....	174
TRACK NAMES IN GRID .....	174
PROJECT INFO .....	175
SHUTTLE X5 MODE .....	176
UNDO CONFIRMATION .....	176
AUDIO SETUP .....	177
CLOCK SETUP .....	178
USER BANK .....	179
OS UPDATE .....	180
DISK .....	182
CLEANUP DISK .....	183
DISK TOOLS .....	183
DISK FORMAT .....	184
AUDIO RECOVERY .....	185
PERFORMING AN AUDIO RECOVERY .....	187
<b>CD-RECORDER</b> .....	<b>188</b>
DOWNSAMPLING PROJECTS FOR CD MASTERING .....	190
HOW TO PREPARE MATERIAL FOR DISK-AT-ONCE .....	191
MIXING DOWN .....	193
MULTI-BAND COMPRESSOR/EXPANDER .....	194
LOADING/SAVING MBCX PRESETS .....	198
MASTERING ON THE DPS24 .....	199
CD PLAYER .....	201

---

<b>EXT SYNC KEY</b> .....	<b>202</b>
SETTING EXT SYNC OFFSETS .....	203
<b>INTEGRATING ADAT™MACHINES</b> .....	<b>203</b>
24-TRACK TRANSFER - ADAT TO DPS24 .....	205
24-TRACK TRANSFERS - DPS24 TO ADAT .....	205
OTHER APPLICATIONS FOR THE ADAT EXPANSION OPTION .....	205
ADAT AND DIGITAL CLOCK .....	206
<b>APPENDIX</b> .....	<b>207</b>
MIDI Implementation Chart .....	207
Block Diagrams .....	208
Installation of Options - To service Technicians .....	212
OS Upgrade via USB (PC only) .....	213
OS Upgrade via CD (PC only) .....	214
ASCII Keyboard commands .....	215
ADAT™ LRC Key Assignment .....	215
<b>SPECIFICATIONS</b> .....	<b>216</b>
<b>INDEX</b> .....	<b>218</b>



---

# INTRODUCTION

---

## FEATURES

Thank you for purchasing the DPS24 24-track personal studio. The DPS24 is packed full of highly professional features that allow you to make digital multi-track recordings and mixdowns in one convenient unit. These include:

- 24-track hard disk recorder/editor offers non-compressed 16/24-bit linear operation at 32/44.1/48/88.2/96kHz sampling rates with non-destructive multi-track real-time editing (cut, copy, paste, insert, move, etc). (12 tracks at 88.2kHz and 96kHz sample rates)
- Off-line DSP functions include stereo, phase coherent timestretch, pitch shift, BPM matching, varispeed, reverse, normalise and resample.
- 20 levels of UNDO/REDO
- 256 'Virtual Tracks'
- 46-channel digital mixer with 8 groups, phantom power (inputs 1-4), multi-channel ADAT digital I/O, stereo SPDIF digital I/O, talkback, 2-track input, stereo AUX input and internal digital patchbay. (24-channel mixer at 88.2kHz and 96kHz sample rates)
- All mono Inputs and disk Tracks have 3-band semi-parametric EQ and dynamics processing (compressor and gate) per channel.
- Inputs and disk tracks have 4 pre/post sends individually switchable to Internal effects or AUX sends per channel. (2 sends per channel at 88.2kHz and 96kHz sample rates)
- Over 50 real-time effects (x 4 channels) which include reverb, delay, chorus, flanger, phase shifter, pitch shifter, auto-pan, wah, rotary speaker simulation, distortion, EQ, noise gate, compressor/limiter, enhancer and real-time pitch corrector. (x2 channels at 88.2 and 96kHz)
- 24 x balanced analogue inputs (12 x 2 banks) reduces the need for re-patching.
- Balanced send/return analog inserts on Inputs 1-4 can also be used as preamp bypass inputs.
- 100mm long throw touch sensitive, motorized faders.
- Q-STRIP gives quick and convenient access to pan and effects/aux sends.
- Q-CHANNEL puts an entire channel of controls (pan, EQ, sends) at your fingertips and the collar of LEDs around the control show each control's position.
- Q-LINK controls alongside the LCD gives quick and easy access to on-screen parameters.
- MAIN and NEARFIELD monitor outputs with dedicated console switch.
- Dedicated MONO switch allows mono reference monitoring.
- STUDIO outputs feed headphone monitoring in separate recording area with built-in talkback.
- Dedicated tape-like transport keys and JOG/SHUTTLE wheel for multi-track scrubbing.
- Autolocator with 100 locate points per project.
- External sync to SMPTE (optional) and MIDI timecode.
- 320 x 240 greyscale LCD offers an intuitive and easy-to-use operating environment.
- CD-RW option allows back-up and mastering.

# DPS24 STRUCTURE

Internally, the DPS24 is laid out much like any conventional recording studio:

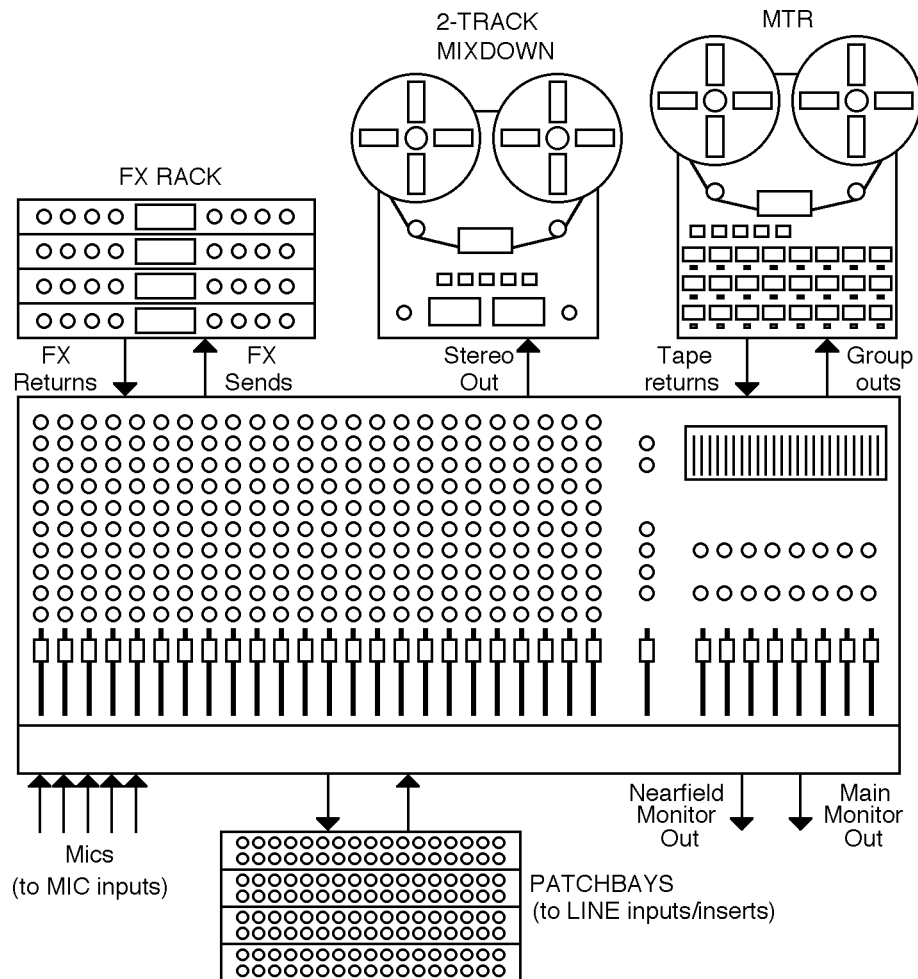

At the heart of this 'typical' studio is a large, multi-channel mixer.

This mixer has 46 channels: 12 mono + 1 stereo inputs, 24 track returns and 4 stereo FX returns.

The mixer's 8 GROUP outputs are connected to the inputs of the MTR (multi-track recorder) and inputs are routed to tracks on the MTR via these. The outputs of the MTR are fed back into the mixer where the tracks can be mixed, EQ'd, etc.. Microphones are connected to balanced mic inputs on the mixer and line sources are patched to the line inputs. The effects sends are connected to the effects processors and the outputs of these are connected to the mixer's effects return channels.

The mixer's stereo L/R outputs are connected to a stereo mastering machine. The outputs of the stereo recorder can be patched through a mastering compressor/expander, before feeding a CD recorder (not shown here).

Monitor outputs feed an amplification system and, as is common in high-end studios, there are two monitor outputs - one feeds the control room's main monitoring system whilst another feeds a smaller monitoring system (maybe a domestic hi-fi) for checking a mix on smaller speakers. Also in this typical studio (but not shown here) would be compressors, noise gates and so forth.

If you are familiar with this setup, then you already understand most of the DPS24 as this is pretty much what the DPS24 offers!

However, instead of separate analog units, all the above is done digitally within the DPS24 so that you enjoy the benefits of superior sound quality, automated mixing, non-destructive editing and much more besides in one convenient unit.

The obvious benefit of the DPS24 versus individual components is the simplification of the cabling between components. No need for expensive "snakes" between the mixer and the recorder, etc. All the cabling required is the connection from the sources and to the monitors.

Another advantage is that the data and parameters of all included components are stored together, on the hard drive, in a single file for each song, called a PROJECT.

When loading a Project, the whole system is recalled in a single operation: audio tracks, edits, routing, mixer (levels, EQ, ...) and automation, effects settings.

In the same way, when Projects are backed-up or restored (which can be done via CD-R, SCSI or USB), the data for the whole system is included.

This reference manual covers the general operation of the various components included in the DPS24.

Take a little time to look at the control panel and get familiar with the various keys and controls of the surface.

As you will see, everything in the DPS24 is laid out very logically:

The Multi-Track recorder/editor is controlled using the 24 RECORD/EDIT SELECT keys for arming/editing the 24 Tracks and the full TRANSPORT section, including the GOTO and MEMORY keys for auto-locate functions, as well as the JOG/SHUTTLE wheel for audio scrubbing. A scrolling graphic view of the 24 tracks is displayed using the GRID key (SHIFT+MAIN SCREEN).

The Editing functions are accessed via the EDIT/DSP mode key and the Virtual Tracks via the V.TRACK key (SHIFT+PROJECT).

The Mixer section is controlled using the FADER BANK keys, the Faders, Channel ON keys (for Mute/Solo) and Channel SELECT keys, the Q-CHANNEL/Q-STRIP encoders and keys, the MIX SCENE STORE and RECALL keys, and of course, the MIXER key.

The Automation is accessed via .... the AUTOMATE key.

The Patch Bay is controlled using the ASSIGN L/R and GROUP keys, and of course, the PATCH key (SHIFT+MIXER)

The Effects are accessed via.... the FX key.

Projects are managed in the PROJECT mode.

Global Project settings are accessed via the SETUP key.

Finally, Audio CD writing functions are accessed via the CD-R key (SHIFT+SETUP).

The detailed operation of all those controls is described in this manual.

**NOTE:** Recording via Groups is only the default configuration of the DPS24. However, if you are not familiar with 8-buss recording operation, the routing of the DPS24 can be changed to bypass the groups, by patching inputs directly to tracks. Please refer to the PATCH mode for more details.

# REAR PANEL

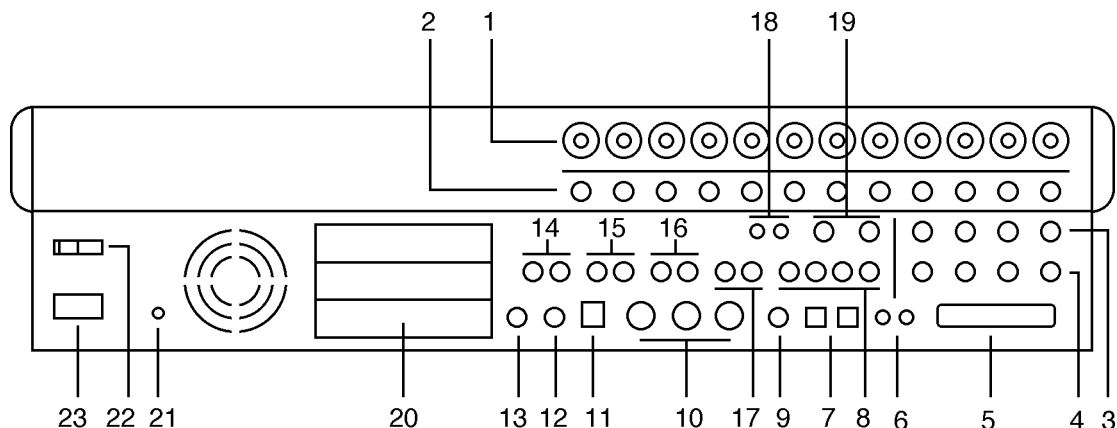

The rear panel has a comprehensive selection of connectors to interface the DPS24 with a wide range of analogue and digital equipment. These are:

## 1. INPUTS - BANK A

Across the top of the rear panel are the two banks of analog inputs. The top row (Bank A) are balanced inputs on XLR/TRS jack combos. These can accommodate XLR connectors or TRS (tip, return, send - stereo) 1/4" jack plugs.

## 2. INPUTS - BANK B

The second row of inputs (Bank B) are TRS jacks that can accommodate balanced inputs. Banks A and B are switched from the front panel using the switches across the top of the panel.

## 3. CHANNEL INSERT SENDS/DIRECT OUT

## 4. CHANNEL INSERT RETURNS/ADC INPUTS

Inputs 1-4 also feature balanced insert points allowing you to patch in professional external processors such as noise gates, compressors, etc.. Although each channel of the DPS24 has a compressor/gate, you may want to use external valve units or other devices.

The channel insert sends (3) can also be used as balanced direct outputs and the channel insert returns (4) can also be used to accept external pre-amps or 19" 'channel strips' therefore by-passing the internal pre-amps on the DPS24 for these channels.

## 5. SCSI CONNECTOR OPTION

The optional 68pin Wide-SCSI interface IB-24SCSI may be installed here allowing you to connect external SCSI drives to the DPS24.

## 6. DIGITAL I/O

These RCA phono connectors offer SPDIF digital audio input and output. The input is freely assignable to channels within the DPS24 and the output can accept a wide variety of internal audio sources (the default is the master stereo L/R output).

## 7. MULTI-PURPOSE LIGHT PIPE I/O

These optical connectors can be configured to carry either stereo SPDIF or 8-channel ADAT, digital input/output.

## 8. AUXILLIARY SENDS 1-4

AUX SENDS 1-4 default to being output here for use with external effects processors. How-



ever, it is possible to patch other audio sources to appear at these outputs if you wish.

#### 9. WORDCLOCK I/O

When wordclock is selected as the sync source, this BNC is set to receive wordclock. At all other times, this BNC is set to generate wordclock.

#### 10. MIDI IN/OUT/THRU

The MIDI IN connection can accept MIDI Time Code for synchronising to external equipment such as sequencers.

The MIDI OUT connector can generate MIDI Time Code or MIDI Clock so that sequencers, etc., may be synchronised to the DPS24. The MIDI OUT can also generate MIDI Controller events such as volume and pan allowing the DPS24 to control (mix) external equipment (for example, samples, sound modules, etc.).

The MIDI THRU connection passes MIDI data received at the MIDI Input.

#### 11. USB CONNECTOR

This is provided for connection to a personal computer using the akSys TrackView software or the akSysServer audio file transfer utility.

#### 12. PS2 KEYBOARD CONNECTOR

You may attach a PS2 keyboard here to assist with naming items in the DPS24. The key mapping of the keyboard to DPS24 functions is shown in the appendix section.

#### 13. FOOTSWITCH INPUT

This 1/4" jack socket can accept a footswitch for hands-free recording and playback of the DPS24. This input can also accept an Alesis LRC remote controller allowing simple remote control (when overdubbing vocals in a separate studio or vocal booth, for example).

The key mapping of the LRC to DPS24 functions is shown in the appendix section.

#### 14. MASTER STEREO OUTPUT

These balanced outputs should be connected to the line inputs of your stereo mastering machine.

#### 15. MAIN MONITOR OUTPUT

These balanced outputs should be connected to the line inputs of your main control room monitor amplifier or powered speakers.

#### 16. NEARFIELD MONITOR OUTPUT

These balanced outputs should be connected to the line inputs of a smaller monitoring system powering smaller speakers. You may switch between the MAIN and NEARFIELD monitoring systems using the NEAR switch in the monitoring section of the DPS24's control surface.

#### 17. STUDIO FOLDBACK OUTPUTS

These outputs should be connected to a separate monitoring system (typically an amplified headphone monitoring system) located in a separate studio recording area, vocal booth, etc.. The audio feed to these outputs is derived via AUX 3/4 allowing an independent mix to be sent to these outputs when track laying and overdubbing.

**NOTE:** When either of the STUDIO OUTPUTS are enabled, the respective AUX output (3 and/or 4) is disabled. This is selected in the MIXER / FX/AUX SETUP page.

#### 18. 2-TRACK INPUT

You should connect the outputs of your stereo mastering machine to these RCA phons. You can monitor this input using the 2-TRACK switch found in the monitoring section of the DPS24's control surface. However, the 2-TRACK input can also be freely patched within the DPS24 and used as a record source if you wish.

**19. AUX IN**

This is a balanced stereo input that can be used for a variety of purposes. It can be used to bring in an external sub-mixer (for example, to expand the number of input channels for sound modules, samplers, drum machines, etc., that may be being sequenced during mixdown) or it can be used as a stereo effects return. By default, this signal feeds the main L/R bus via the stereo AUX mixer channel prior to the master stereo fader. However, the AUX IN can also be freely patched within the DPS24 and used as a record source if you wish.

**20. EXPANSION SLOTS**

These three slots can be used to accept a variety of optional expansion cards, such as:

- \* IB-24ADT : ADAT<sub>1</sub> Expansion card, adding 16 more channels of ADAT<sub>1</sub> digital input output and an ADAT<sub>1</sub> SYNC OUT connector to control the transports of ADAT<sub>1</sub> machines from the DPS24.
- \* IB-24LTC : SMPTE/EBU Time Code Reader/Generator card for synchronization with other devices such as Tape machines and Video decks.
- \* The third expansion slot is reserved for future options.

**21. GROUND TERMINAL**

Connect this to some earthed metalwork if you experience any mains hum or interference as it may help reduce it.

**22. POWER SWITCH**

This is used to switch the DPS24 on and off.

**23. POWER CONNECTOR**

This should be attached to a suitable cable connected to a mains power source.

# FRONT PANEL

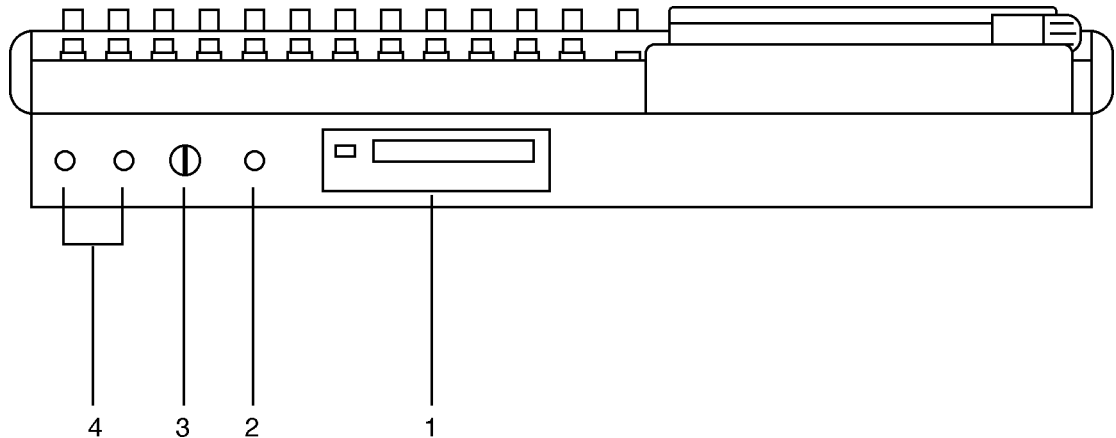

## 1. CD-RW/CD-R DRIVE BAY

An IDE CD-RW is installed here.

It is also possible to install a removable IDE hard drive bay.

## 2. HI-Z GUITAR INPUT

An electric guitar (or bass guitar) may be DI'd into this high impedance input.

Note that when a jack is plugged into this input, it uses Input Channel 12, and Inputs 12A and 12B on the rear panel are overridden and cannot be used.

## 3. HEADPHONE LEVEL

This allows control of the level of the signal appearing at the headphone outputs.

## 4. HEADPHONE OUTPUT

Two headphone output connectors are provided. Both are identical (i.e. wired in parallel) and carry a duplicate of the MONITOR output.

# TOP PANEL

---

## GETTING AROUND THE DPS24

This section deals with the DPS24's control surface. Although we would like to think that most of it should be fairly self-explanatory, please read this section to gain a full understanding of the DPS24's functions.

The panel is laid out logically with many dedicated keys that provide direct access to the most commonly used functions employed when recording, track laying, overdubbing and mixing and the DPS24's control surface is designed in such a way that for every day use, it should not be necessary to access obscure, LCD-driven menus - with its 'knobby' front panel, operation is designed to be as 'hands-on' and 'traditional' as possible. For example....

For track laying, route the inputs to the appropriate track(s) using the Group function as on a traditional mixer, arm the track(s) for record and press PLAY and RECORD together. Drop out of record by pressing PLAY again. To overdub, rewind, re-group, select different tracks for record and repeat the process, monitoring previously recorded material via the DISK TRACKS fader bank.

Want to pan your tracks? Simply use the row of encoders above the faders. Want to add effects? Select the appropriate FX send in the Q-STRIP FUNCTION panel and adjust the encoders to set FX send levels as necessary.

Need to tweak EQ? Select the appropriate channel(s) using the channel SELECT keys, press the Q-CHANNEL key and adjust the EQ using the Q-CHANNEL encoders.

Need to tweak an effect? Press FX and use the Q-LINK controls to modify parameters (and with the Q-CHANNEL selected, you can adjust the channel parameters AND the effects parameters simultaneously).

If you are working with artists in separate rooms, set up a 'foldback' cue mix using pre-fade AUX 3 and/or 4 and the STUDIO outputs - even speak to them via the DPS24's internal talkback mic during the track laying process.

Having laid down some tracks, you hear something that needs deleting! Simply hit EDIT, select the appropriate track(s), mark the offending region with the IN/OUT keys and press CUT or ERASE. Similarly, you want to use that one great guitar riff elsewhere in the project - select the appropriate track(s), press EDIT, mark the region, copy it and paste it wherever it's needed.

You get the picture!

And so far, unlike other digital mixers/recorders, all of this is achieved without hardly ever having to refer to the LCD!

To find out more, read on.

## ILLUMINATED KEYS

Illuminated keys will light when selected as you would expect.

However, in certain circumstances, these keys flash to indicate that they are in a different status. For instance, the CH ON keys are lit when mixer channels are ON (not muted), but they flash when the mixer channels are solo'ed.

Also, the RECORD/EDIT SELECT keys for the 24 tracks use bi-color LEDs, red for Record (flashing when ready, lit when recording) and green for Edit,

# INPUTS

Across the top of the panel are controls associated with the twelve analog input preamps.

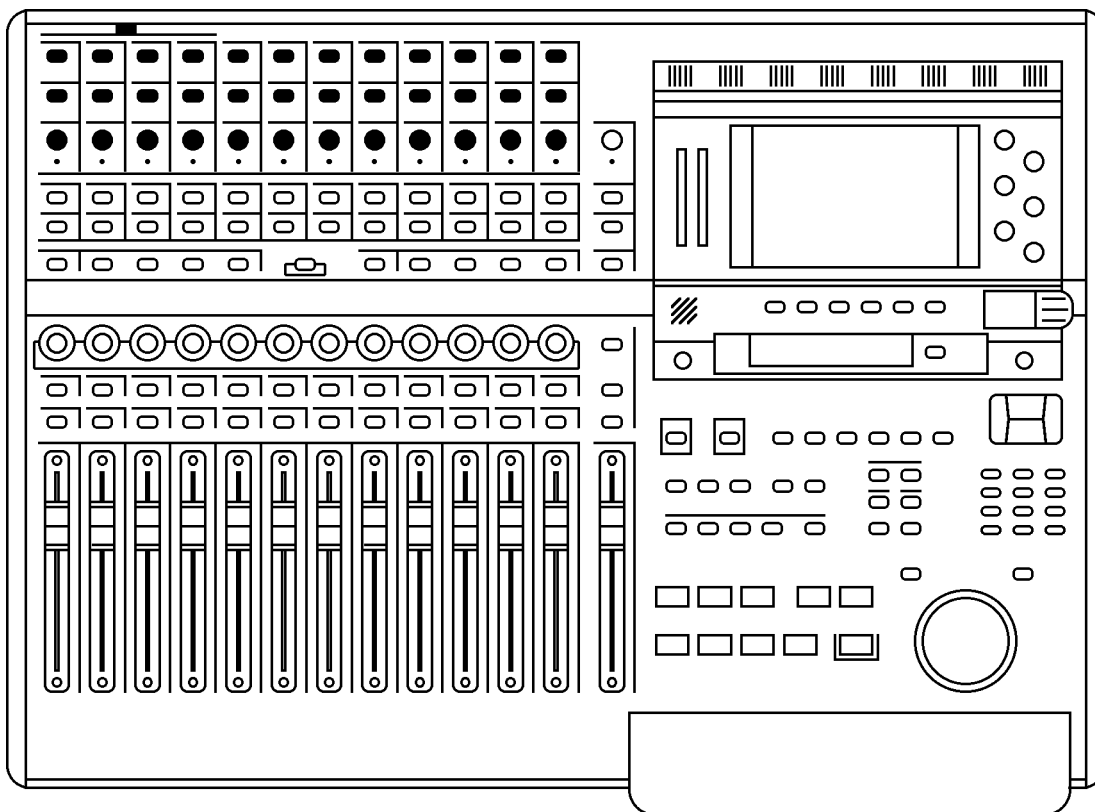

The functions are:

**48V ON/OFF** Switches on 48 volt phantom power to Inputs A 1-4 allowing these channels to be used with condenser mics.

**A/B** The switches running along the top switch between Input A or B.  
(A is the XLR combo, B is the 1/4" jack)

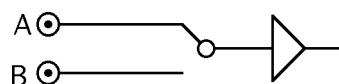

**LINE/MIC** The next row of switches set the input (TRIM) sensitivity between line (-15dB <-> +45dB) and mic (0dB <-> +60dB).

**TRIM** This pot allows you set the input channel's initial gain according to the setting of the LINE/MIC switch.

**SIG/CLIP** This tri-coloured LED shows the level of the input signal after the input pre-amp. It illuminates as follows:

- 60dB or less      OFF
- 60dB -> -3dB    GREEN
- 3dB                YELLOW
- 0dB                 RED (clip)

## RECORD/EDIT SELECT KEYS

Below the inputs are the RECORD/EDIT SELECT keys for Tracks 1-24:

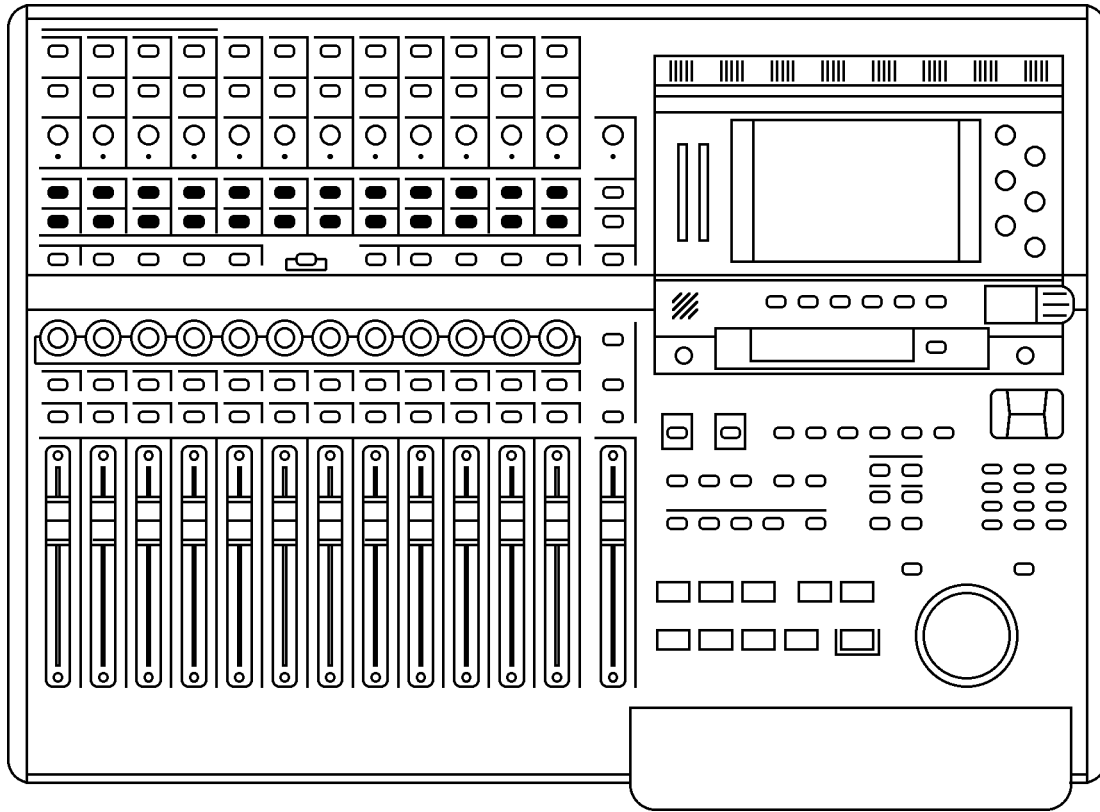

These keys have bi-coloured LEDs and normally, when recording, they illuminate red and are used to select tracks for record. However, when the EDIT mode is enabled, these keys illuminate green and are used to select tracks for editing.

The number shown to the right of each key shows the default Group assignment. As on a 'traditional' console/recorder combination, the group outputs are patched to the disk tracks and channels are routed to them by way of the Groups (Groups 1-8 routed to Tracks 1-8, 9-16 and 17-24). So, for example, to route Input 5 to Track 3, you would assign it to GROUP 3/4. To route, say, Tracks 1, 2, 3 and 4 to, say, Tracks 13 and 14 for a stereo bounce-down, you would assign them all to GROUP 5/6.

**NOTE:** Because of the flexible patching facilities in the DPS24, it is possible to override the default group routing arrangement so the default assignment shown alongside the record track numbers may not be applicable if you have changed them. Routing and patching is explained in more detail later in this manual.

## L/R AND GROUP ASSIGN KEYS

Below the RECORD/EDIT SELECT keys to the left of the panel are the ASSIGN keys:

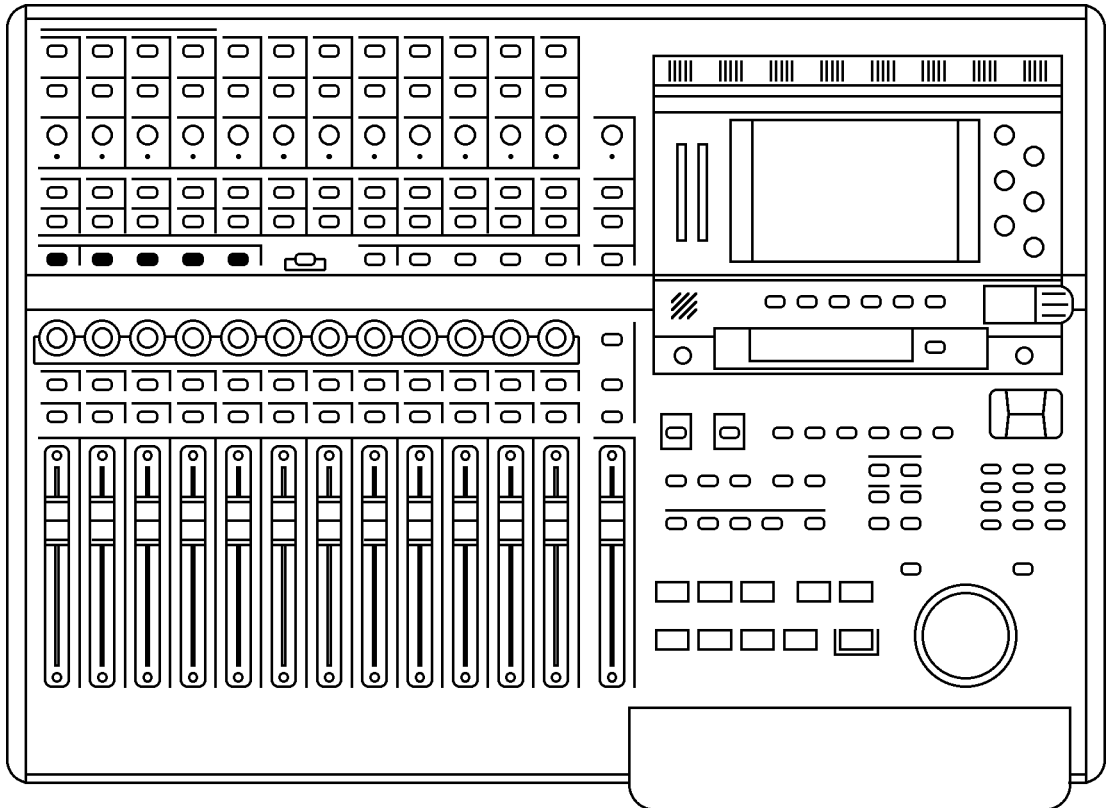

These allow you to route signals to the groups and also to the stereo L/R bus.

To route any channel to a Group (and hence to the track(s)), press the desired GROUP key. The current GROUP key will flash. The SELECT keys for any channels assigned to that group will illuminate whilst those that aren't assigned will flash. Press the channel SELECT keys for the channels you wish to assign (or press an illuminated key to de-assign a channel).

When done, press the GROUP key again to return to normal mode. The GROUP key will stop flashing.

**NOTE 1:** If a channel SELECT key is not lit nor flashing, it means that the channel in question cannot be routed to that bus. This applies to GROUP, AUX and MIDI mixer channels.

**NOTE 2:** Almost any channel can be assigned to any group. However, it is not possible to assign groups to groups. Groups can be assigned to the stereo L/R bus, however.

**NOTE 3:** In normal operation, i.e. when not assigning channels to groups, the GROUP keys should not be flashing.

To assign a channel to the L/R output bus, press the L/R key. The L/R key will flash. The SELECT keys for any channels assigned to the L/R bus will illuminate (and those that aren't will flash).

Press the channel SELECT keys for the channels you wish to assign (or press an illuminated key to de-assign a channel).

When done, press the L/R key again to return to normal mode. The L/R key will stop flashing.

**NOTE:** In normal operation, i.e. when not assigning channels to the L/R bus, the L/R key should not be flashing.

## SUB-GROUPING CHANNELS TO THE L/R MIX

Very often (especially during mixdown), it is very useful to be able to sub-group certain channels to the stereo L/R bus via the Groups. For example, all your drums and percussion channels could be sub-grouped to one group, all your keyboard parts to another, all your backing vocals to another, etc., so that you have control over these elements with a single Group fader.

Routing groups to the stereo L/R bus is done simply by pressing the L/R key and, in the GROUPS/FX fader bank, pressing the group channels' (1-8) SELECT key(s) as appropriate. This is consistent with assigning other channels to groups.

**NOTE:** Channels which are routed to a sub-group need to be taken out of the stereo L/R bus to avoid them appearing twice. - once through the direct connection of the channel to the stereo L/R bus and secondly through its connection to the stereo L/R bus via the subgroup.



## Q-STRIP FUNCTION KEYS/CHANNEL ENCODERS

Below the RECORD/EDIT SELECT keys to the left of the panel are the Q-CHANNEL key and the Q-STRIP FUNCTION keys:

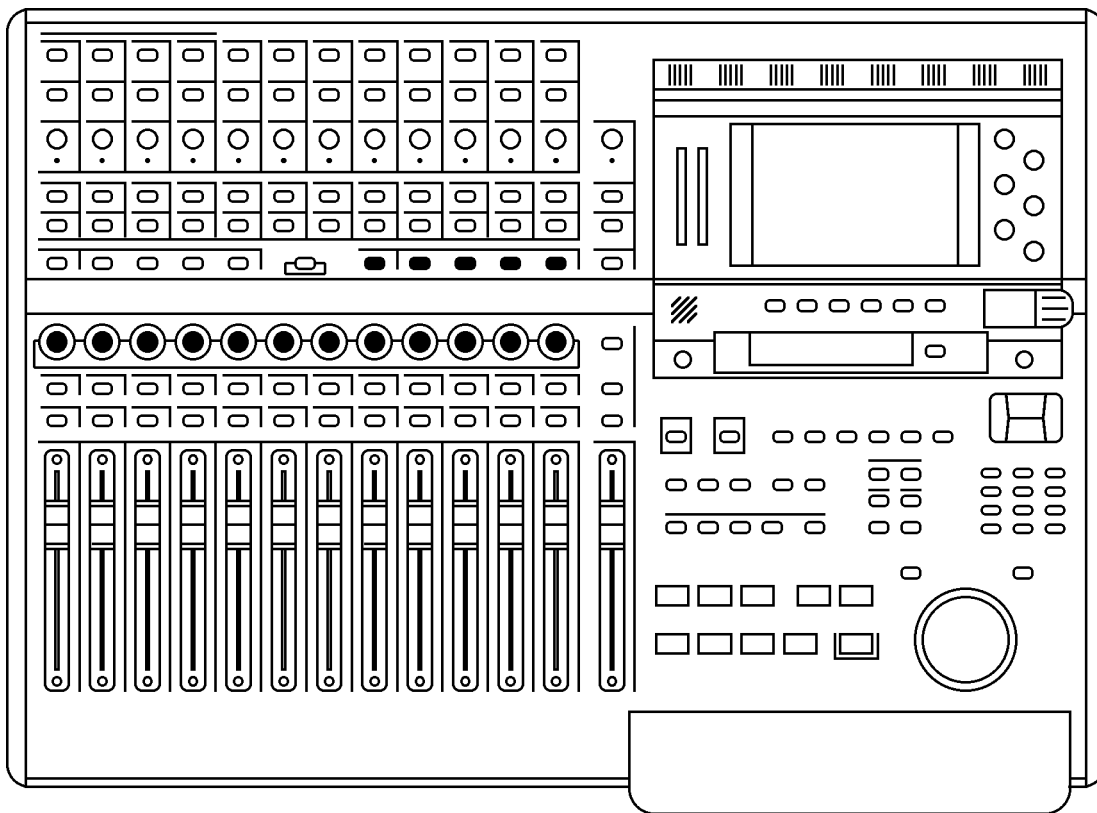

Directly above the channel faders is a row of continuous rotary encoders (the Q-STRIP / Q-CHANNEL) with a 'collar' of LEDs around each of them that serve a variety of purposes.

When the Q-CHANNEL key is off, they operate as the Q-STRIP.

On power up, their default function is to act as PAN controls with one pan control for each of the channels of the current Fader Bank.

However, they may be used to set FX/AUX send levels.

This functionality is selected using the Q-STRIP FUNCTION keys:



**PAN** : Sets the rotary encoders to act as pan controls for each of the channels.

**FX/AUX 1-4** : Sets the rotary encoders to act as send levels for the internal effects channels or to the AUXILIARY bus.

**NOTE:** If the sends are configured as stereo sends, FX/AUX1 sets the send level and FX2 sets the pan position. The same is true for FX/AUX3/4 - if set to stereo, FX/AUX3 sets the level and FX/AUX4 sets panning.

## FADER FLIP

It is also possible to 'flip' (or swap) the faders and FX/Aux sends allowing you to set FX/Aux sends using the motorized faders. This is useful when you require very abrupt changes to FX/Aux sends... to allow for precision when setting the FX/Aux send levels, the encoders need a few turns to cover the entire range. The faders, on the other hand, can cover the entire range in one swift movement.

To flip the faders, simply 'double-click' the FX/Aux buttons:

Press the FX/Aux key once to select it. Press it again to 'flip'.

When 'flipped', the faders set FX/Aux send level and the encoders now set channel level.

When 'flipped', the LED in the key will flash to indicate its status.

Press it again to return to normal operation.

**NOTE:** If the sends are configured as stereo sends, when FX/AUX1 is 'flipped', the faders set FX/Aux1/2 send level and the encoders set the channel level.

However, when FX/AUX2 is 'flipped', the faders set FX/Aux1/2 send level and the encoders set FX/AUX1/2 send pan position. The same is true for FX/AUX3/4.

## Q-CHANNEL SELECT/Q-CHANNEL ENCODERS

In the centre of the panel is the Q-CHANNEL key:

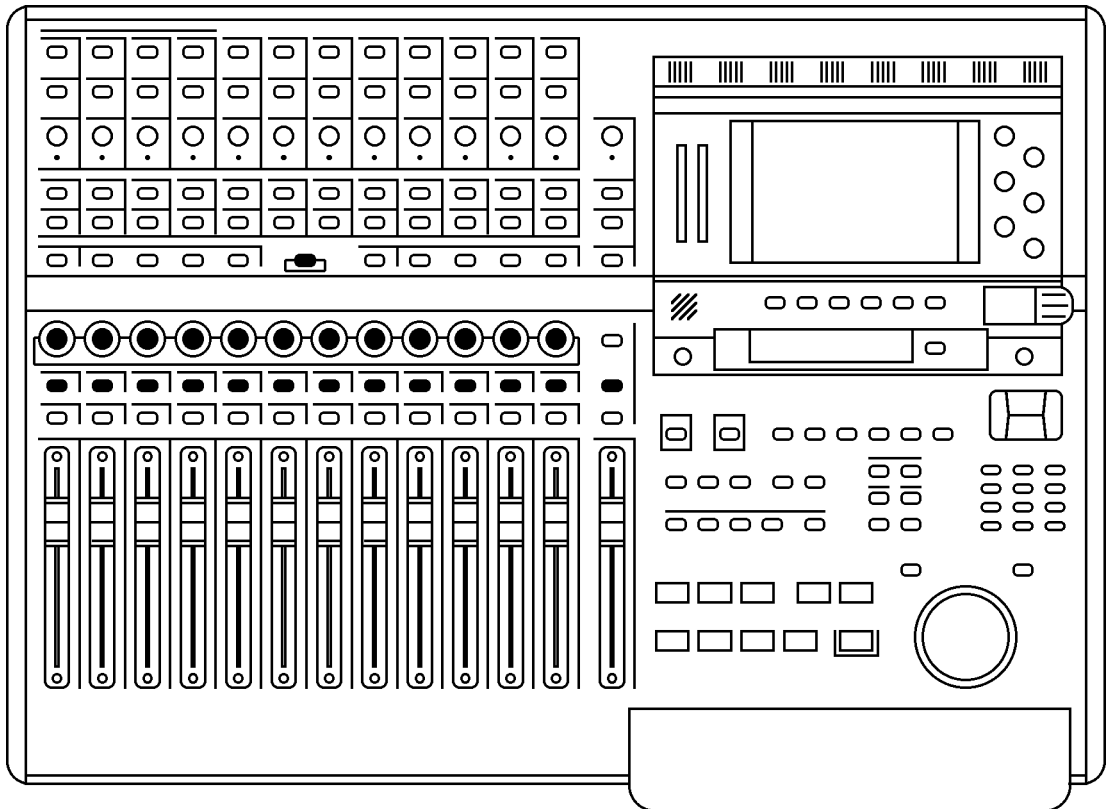

One of the most useful features of the DPS24 is that the row of encoders directly above the faders can be switched to become a complete channel's worth of parameters allowing you to have 'hands-on' control of panning, EQ and FX/Aux sends. This 'mode' is enabled by pressing the Q-CHANNEL switch located centrally on the upper panel.

When the Q-CHANNEL key is on (illuminated), the encoders function as a complete channel strip for the selected Channel as follows from left to right (as labelled underneath the encoders):

- PAN
- LOW SHELF EQ FREQUENCY
- LF GAIN
- SWEEP EQ FREQUENCY
- SWEEP EQ GAIN
- SWEEP EQ 'Q'
- HIGH SHELF EQ FREQUENCY1
- HF GAIN
- FX/AUX 1 SEND LEVEL
- FX/AUX 2 SEND LEVEL
- FX/AUX 3 SEND LEVEL
- FX/AUX 4 SEND LEVEL

Furthermore, the function of the Q-STRIP FUNCTION keys described earlier also change when the Q-CHANNEL is enabled:

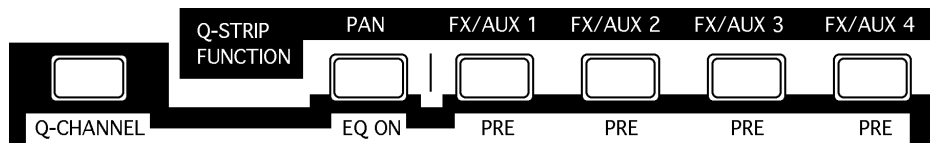

The labelling underneath the keys denotes their function when in Q-CHANNEL 'mode' and you have 'hands-on' control to bypass the EQ and to switch FX/AUX 1-4 as pre- or post-fade.

Of course, for the Q-CHANNEL 'mode' to be applicable, you must select a channel for editing (i.e. you should press a channel's SELECT key just under the row of encoders). The SELECT key of the selected Channel is illuminated. On power up, the default selection is the Master Channel.

**NOTE:** Enabling Q-CHANNEL automatically calls up the MIXER / CHANNEL page of the selected Channel on the LCD. Then, when disabling Q-CHANNEL, the display returns to the previous screen.

## Q-STRIP/Q-CHANNEL ENCODERS

Around the encoders is a collar of LEDs that show the encoder's value. As the control is moved, so do these LEDs illuminate to show its position. However, the way these LEDs illuminate depend on the control's function.

### PAN POSITION / EQ FREQUENCY

When used as a pan pot, the LEDs around the encoders illuminate as follows:

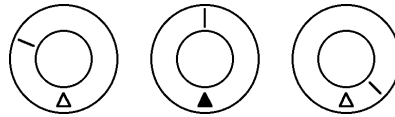

When the encoder is set to MID, the red LED at the bottom illuminates as well. This is to assist with viewing the encoder(s) at an angle where the top middle LED may not be visible.

### LEVEL CONTROL

When the encoders are used as level controls (e.g. FX/AUX SEND), the LEDs illuminate as follows:

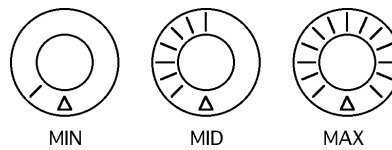

### EQ GAIN

When the encoders are being used to set EQ gain in the Q-CHANNEL, the LEDs illuminate as follows:

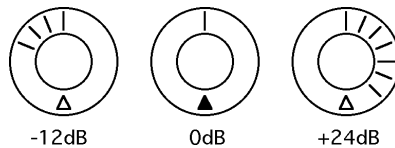

### EQ 'Q'

When the encoder is used to set EQ 'Q' in the Q-CHANNEL, its' LEDs illuminate as follows:

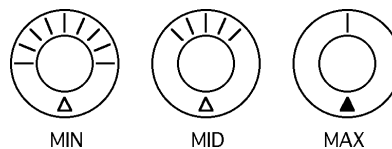

In this way, the control gives an almost graphic indication of the 'width' of the sweep EQ. With the control at minimum, the Q is at its widest; at maximum, the Q is at its narrowest.

## FADERS/FADER BANKS

Below the DPS24's Q-STRIP/Q-CHANNEL encoders are the channel faders and SELECT and ON/SOLO keys:

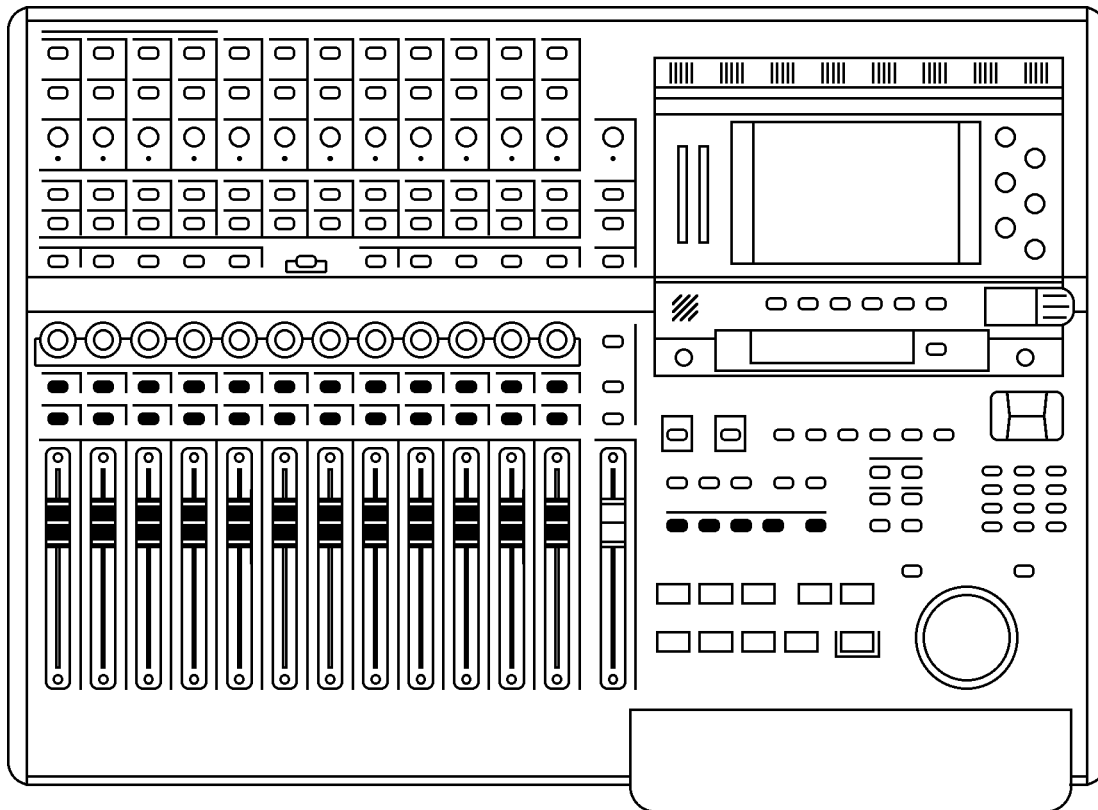

Each channel is identical whether it's an input or a disk channel (the GROUP/FX channels are different and those differences are described on the next page). Each channel has a long throw 100mm motorised fader which is touch sensitive for use with the mixer's automation and simply touching the fader will make it active.

Channels may be muted using the green ON key above the fader.

When the channel is ON, the key illuminates; when it is OFF (muted), the key is not lit.

By pressing SHIFT+ON, the channel can be solo'd.

When a channel is solo'd, the ON key's LED flashes (and a large SOLO LED flashes in the MASTER section). SOLO operation is described later in the manual.

A channel can be selected for tweaking using the channel SELECT key above each fader.

The SELECT keys are also used in conjunction with the ASSIGN keys to route channels to the L/R bus and/or to Groups (and hence to disk tracks) for recording.

The SELECT keys can be used to link adjacent odd/even Channels as a stereo pair.

To link a pair of channels, press the SELECT key of one of the channels while holding down the SELECT key of the adjacent channel. To un-link them, use the same procedure.

Once linked, pressing the SELECT key for either channel will select both, and the ON key of either channel will be used for muting/solo'ing both channels.

**NOTE:** Only odd/even adjacent channels can be paired., not even/odd channels, i.e. you can link channels 1&2 or 3&4, but not channels 2&3.

The different channels are selected using the FADER BANK keys located above the transport keys. The types of mixer channel types are as follows:

INPUTS	12 general purpose mixer channels which can be used to mix the DPS24's various input sources. The channels can also be used to add EQ and dynamics and also to send the channels to either the internal effects and/or the AUX bus. By default, input sources are ADCs 1-12.
TRACKS	24 mixer channels which are sourced from the internal disk recorder. The channels can also be used to add EQ and dynamics and also to send the channels to either the internal effects and/or the AUX bus.
GROUP	8 channels providing control of the 8 group bus master levels. Pan, EQ, dynamics and FX/AUX sends are not available on these channels.
FX RETURN	By default, these 4 stereo channels provide control the stereo returns of the internal effects with balance control and FX/Aux sends. However, these channels can be re-patched to mix any of the DPS24 input sources.
FX SEND	4 channels providing control of the 4 fx bus master send levels.
AUX SEND	4 channels providing control of the 4 aux bus master send levels.
AUX IN	A stereo auxiliary mixer channel allowing the AUX L/R inputs to be mixed to the main L/R bus with level and mute control only. This channel has a fixed source.
MIDI CONTROLLER	16 channels each providing 2 MIDI controllers which can be assigned to any MIDI channel or controller. Controller #1 is controlled by the channel fader and Controller #2 is controlled by the channel's PAN control. By default, these are configured to send MIDI Volume (CC#7) on Controller #1 and MIDI Pan (CC#10) on Contr oller #2.

There are 4 fixed Fader Banks and 5 assignable User Banks arranged as follows :

INP 1-12	These channels control Inputs1-12.
TRACKS 1-12	These channels control Tracks 1-12.
TRACKS 13-24	These channels control Tracks 13-24.
GROUP/FX	Channels 1-8 control the Group Output levels, and Channels 9-12 control the stereo FX return channels (default to internal FX returns)
USER BANK	Selects the first bank of user assignable channels. By default, they are assigned as follows: <ul style="list-style-type: none"> <li>- Channels 1-4 control the master send levels to the FX buss.</li> <li>- Channels 5-8 control the master send levels to the AUX buss.</li> <li>- Channel 9 controls the stereo AUX IN.</li> <li>- Channels 10-12 control MIDI controllers1-3</li> </ul>
SHIFT + INP 1-12	Ext User-Bank 1 (no default assignment)
SHIFT + TRACKS 1-12	Ext User-Bank 2 (no default assignment)
SHIFT + TRACKS 13-24	Ext User-Bank 3 (no default assignment)
SHIFT + GROUP/FX	Ext User-Bank 4 (no default assignment)

The User Banks configurations are assigned in the SETUP mode.

## MASTER SECTION

To the right of the channel faders is the MASTER fader:

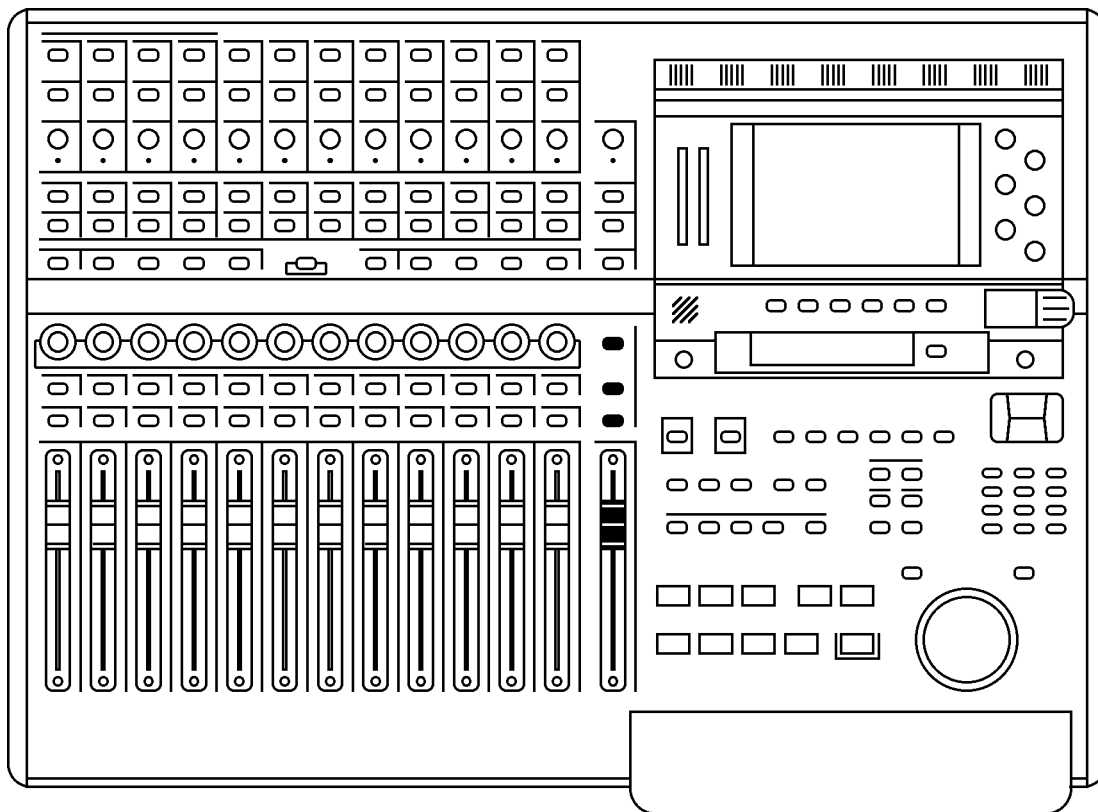

The MASTER section also has a long throw, touch sensitive, motorised fader. This controls the L/R bus which, by default, appears at the STEREO OUT.

**NOTE:** Due to the DPS24's flexible patching system, it is possible to route audio sources other than the L/R bus to the STEREO output. If another audio source is patched to the STEREO output, the MASTER fader will not affect that audio source's level.

Above the fader is a TALKBACK switch. This routes the internal talkback mic to the STUDIO outputs so that the engineer in the control room can talk to the 'talent' in a separate studio area. The key is a 'press-to-make' switch that needs to be held down for the talkback mic to be routed to the STUDIO outputs.

**NOTE:** To facilitate this, the AUX 3/4 sends need to be configured to be sent to the STUDIO L/R outputs. This is set in the MIXER - FX/AUX SETUP page.

The illuminated SELECT key allows you to select the master channel for editing.

The illuminated STUDIO > CR key allows you to route the mix created on AUX 3 and 4 as the STUDIO cue mix to the monitor output feeding the control room's monitoring system. In this way, it is possible for the control room engineer to set the mix up very conveniently on the control room's speakers.

The TALKBACK and STUDIO outputs are explained later in this Reference manual.



## MONITOR SECTION

Directly above the MASTER section is the MONITOR section:

The functions are (from top to bottom):

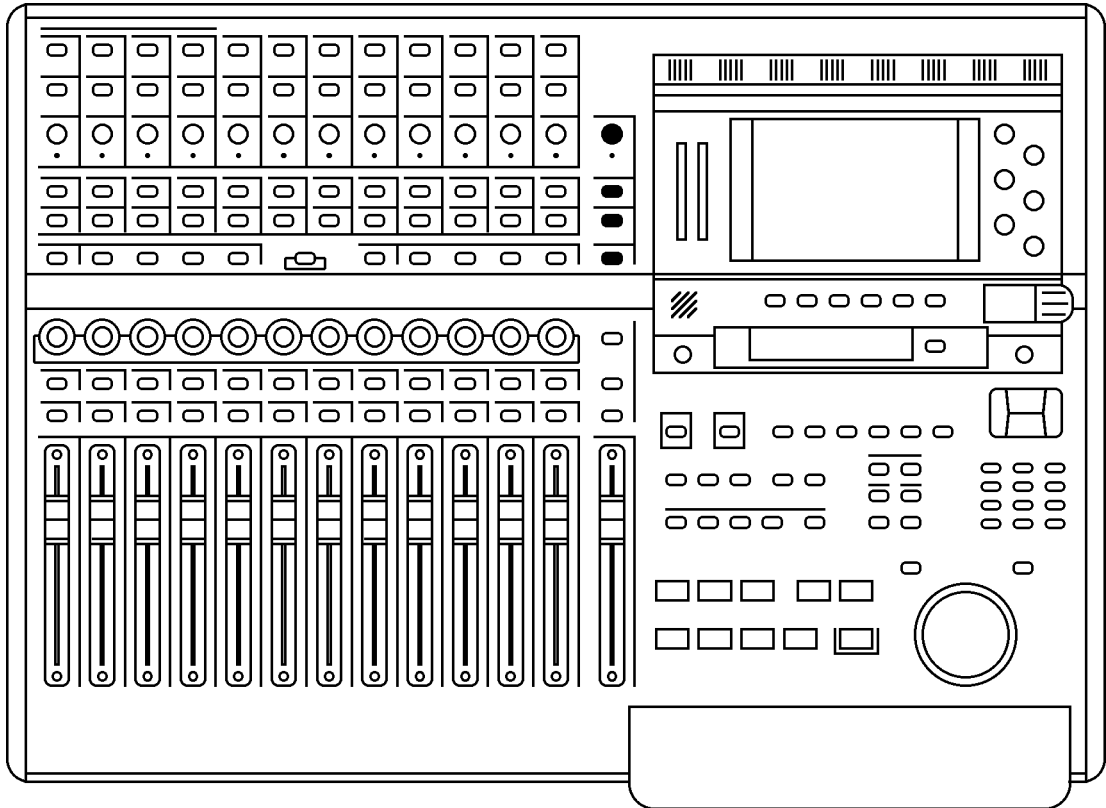

**MONITOR LEVEL** Sets the level of the signal appearing at the MAIN or NEARFIELD monitor outputs.

**!!! SOLO !!!** This LED flashes whenever a channel is solo'd. Although the channel's ON key flashes when it is solo'd making it perfectly obvious which channel is being solo'd, it is possible that a different FADER BANK may be selected and so the solo'd channel may not be visible (for example, Input 5 may be solo'd but the current FADER BANK might be, say, Tracks 1-12). As a result, it may not be clear that a channel is solo'd. This 'master' SOLO LED helps overcome this by showing that a channel somewhere is solo'd.

**2-TRACK** This switches the 2-TRACK input into the main monitor output, overriding the main L/R mix. Normally, this will be used to check the output of an external stereo recorder/player. However, the 2-TRACK switch exists only on the monitor output and it does not affect the master stereo L/R output.

By default, the stereo 2-TRACK input is the source for this, but it is also possible to route the stereo AUX IN or the stereo DIGITAL IN instead in the SETUP mode.

**MONO** This switches the monitor output to mono. Switching to mono does not affect the STEREO L/R outputs, only the monitor outputs (MAIN and NEARFIELD). Thus it is possible to check a mix in mono on the control room speakers without affecting the STEREO L/R mix to the master recorder. Similarly, when monitoring the 2-TRACK input (either after or during mixdown), it is possible to switch to mono for reference checking.

**NEAR** This switches the monitor output from the MAIN outputs to the NEARFIELD connections on the rear panel.

Typically, the MAIN outputs of the DPS24 will be connected to a high quality, high power amp/speaker monitoring system whilst the NEARFIELD outputs will be connected to a smaller system, perhaps even a domestic hi-fi amp powering smaller speakers. Thus, with NEAR switched OFF, monitoring will be via the MAIN monitor outputs but with NEAR switched ON, monitoring will be via the smaller amp/speakers. In this way, you can switch between monitoring systems quickly and conveniently from the DPS24's panel.

## LCD 'POD'

Top right of the meters.

To the right of the LCD are six Q-Link pots, Q1-Q6, used to set parameters on the LCD.

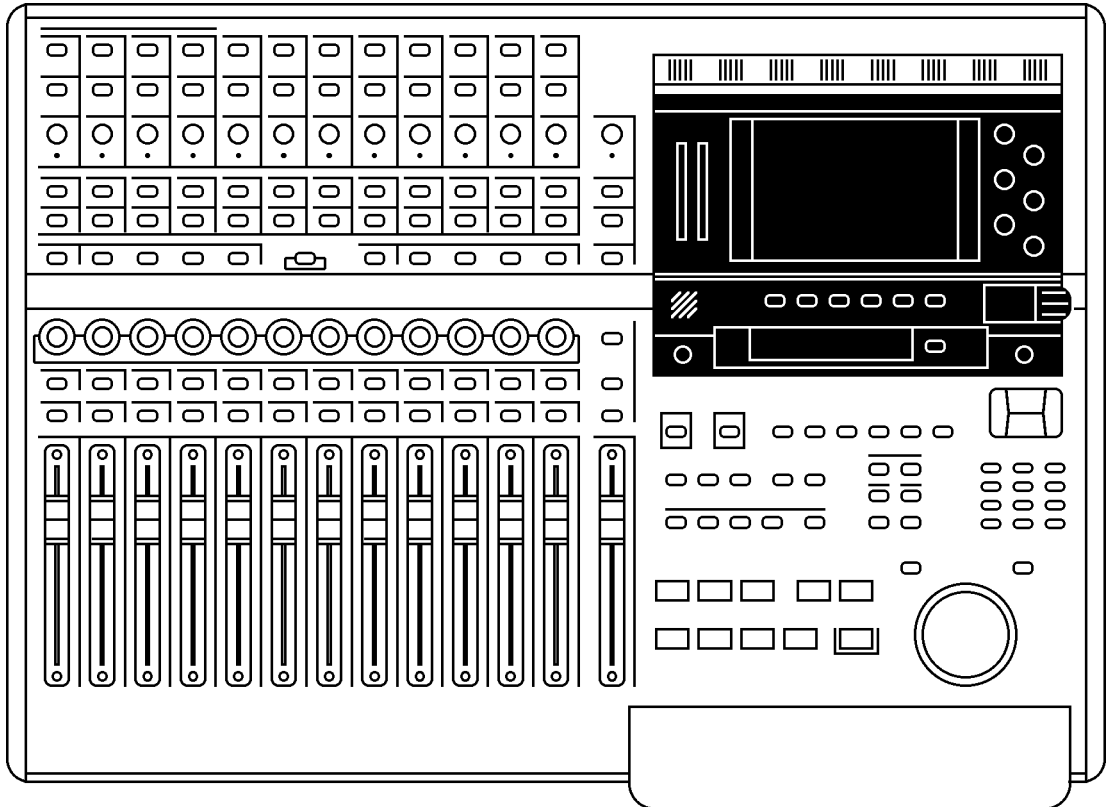

Below the screen are six 'soft' keys, F1-F6, the functions of which change according to the screen being displayed.

To the left of the function keys is a simple talkback mic. Its level can be regulated using the TB LEVEL pot directly below it.

Underneath the function keys is a dedicated timecode display. This can be switched between timecode (hours : minutes : seconds : frames) and BBC (Bars : Beats : Clocks) using the DISPLAY SELECT key to its right. Display status is indicated by two small LEDs between the display and the DISPLAY SELECT key.

Finally, the CONTRAST control allows you to adjust contrast for the best view according to your viewing angle.

## LCD LAYOUT

The layout of the LCD is divided in various sections or blocks.

A typical LCD screen of the DPS24 would look like this:

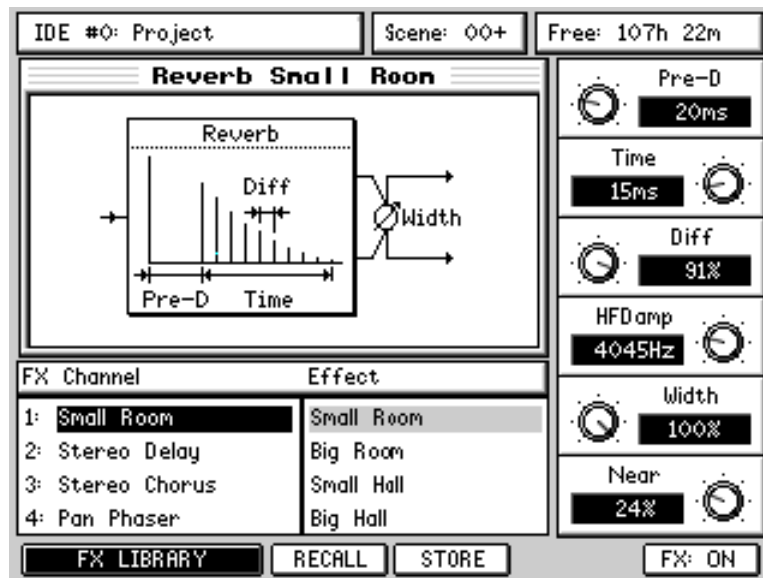

## SOFT KEYS

In all pages, at the bottom of the screen, the functions the softkeys F1-F6 are shown.

There are a few types of soft keys along the bottom of the LCD:

- This is typical 'do it' style key.
- This is a typical 'go-to-another-page' key.

Some soft keys are also uses as ON/OFF switches:

- or  Indicates that a function is on.
- or  Indicates that a function is on.

Double width equivalents also exist:

- 
- 
- 

## PROJECT INFO BAR

In all pages, at the top of the screen, the project drive and the currently active project are shown along with the currently selected mix scene and the amount of free mono recording time on disk.

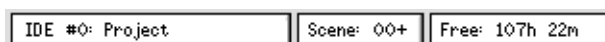

## SAVE INDICATOR

Whenever something is changed in a project, it is autosaved.

When this happens, a small "warning" icon appears in the FREE box at the top right of the display:



**IMPORTANT NOTE:** When this icon appears, it is essential that you do not switch the DPS24 off. Doing so might result in lost data and maybe irreparable damage to your disk drive.

After making any changes to your project, always wait until the icon shown above clears before switching off.

If you turn off the power while saving project data onto hard drive, the project data may be damaged.

As a safety, the DPS24 automatically creates a hidden backup project (a copy of the current project) while saving project data .

In case the original project data gets corrupted, the DPS24 will boot up with the back up project instead.

When the DPS24 boots up with the backup project, something similar to the following message will be displayed as a reminder:

```

=====PROJECT RECOVERY=====
                Project : Messenger Demo

Description                Recovery Date
AutomationNot              Recovered

!!!The above files have been found to be corrupt!!!

The previous versions of these files have been loaded
as dated above.
To avoid corrupting project files, DO NOT switch off
whilst the small exclamation icon is visible in the
top right corner of the MAIN and EDIT screens!!

```

However, please keep in mind that it is still possible to damage project data if you power-off the DPS24 while writing to the disk.

The DPS24 is writing to the disk after any recording, editing or mixing operation (as simple as touching a fader), or after changing any setting.

It usually takes only 10-20 seconds to complete a write operation of the last changes.

Please wait until the icon disappears to power-down the unit.

If the last used Project gets corrupted and the DPS24 is not able to recover the damaged However, you can bypass auto-loading the last project on power-up by using the following procedure:

- \* power-off
- \* turn the shuttle wheel (outer ring) counterclockwise to 11 o'clock (the little notch pointing towards the IN key)
- \* power-up while holding the shuttle wheel in this position until the DPS24 finishes booting up. This will not load the last Project, but create a dummy empty project instead.

From there, you should be able to load other Projects.

You should also be able to recover the audio from the corrupted project using the Audio Recovery feature described later in this manual.

## PROJECT OVERVIEW

In the MAIN SCREEN, and also in the main page of EDIT/DSP modes, a Project Overview is displayed in the lower portion of the screen:



This shows a graphic representation of the 24 tracks of the project, scrolling from right to left across the NOW Time line during playback.

The IN-OUT region is displayed inverted.





On top of the Project OverView, a System Info bar is displayed in the middle of the screen. This provides a reminder of the current Sample Rate, Bit Depth and Frame Rate settings.

## WAVEFORM GENERATION INDICATOR

When new audio files are created, either during recording, or while using the DSP features, the DPS24 calculates each audio file's waveform for display (if the WAVE GEN function is enabled in SETUP/PREFS, as described later in this manual). This operation is performed by the DPS24 in the background.

In the MAIN SCREEN, and also in the main page of EDIT/DSP modes, a Waveform Generation indicator icon is displayed in the System Info bar in the center of the screen shows the status of this background process.

The various displays are:

-  Waveform generation is off
-  This animation shows that waveform generation is in progress
-  Waveform generation complete
-  Waveform generation is inhibited

## METER BRIDGE

In the MAIN SCREEN, and also in the main MIXER page, a Meter Bridge is displayed in the upper portion of the screen, showing small LCD meters for all the channels of the entire Mixer:

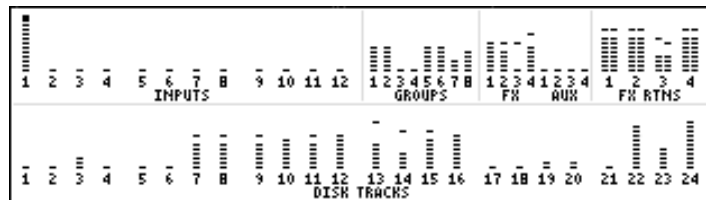

The black squares show clipping and you can also see the peak hold indicators:

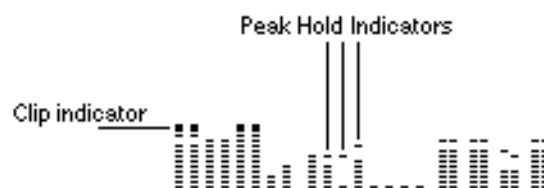

## Q-LINK CONTROLS

In some pages, on the right side of the screen, adjustable parameters are available. Those parameters are adjusted using the corresponding Q1-Q6 Q-Link knobs directly to the right of the screen.

Those Q-link knobs can be used to:

- \* enter parameter values.

For instance, in the FX or CHANNEL Dynamics pages:

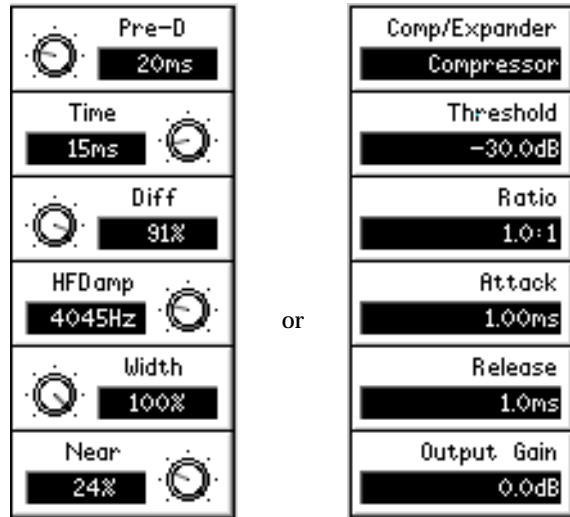

- \* select option parameters.

For instance in the SETUP pages:

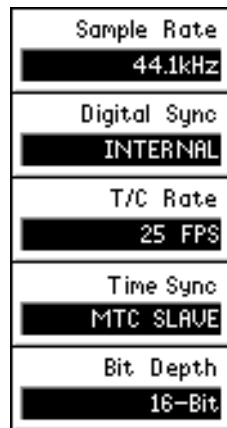

- \* scroll through lists / data entry

In particular, Q5 and Q6 knobs are often used for scrolling/ data entry in as many pages as possible.

In general, if Q5/Q6 are not used for page specific Q-Controls, Q5 moves left-right and Q6 moves up-down, unless one direction is meaningless, in which case the Q-Link knob for that direction becomes data increment/decrement.

Following are some examples:

## MOVING AROUND THE LCD

Most pages provide immediate access to parameters via the Q-LINK controls on the right. An example of this would be the FX pages:

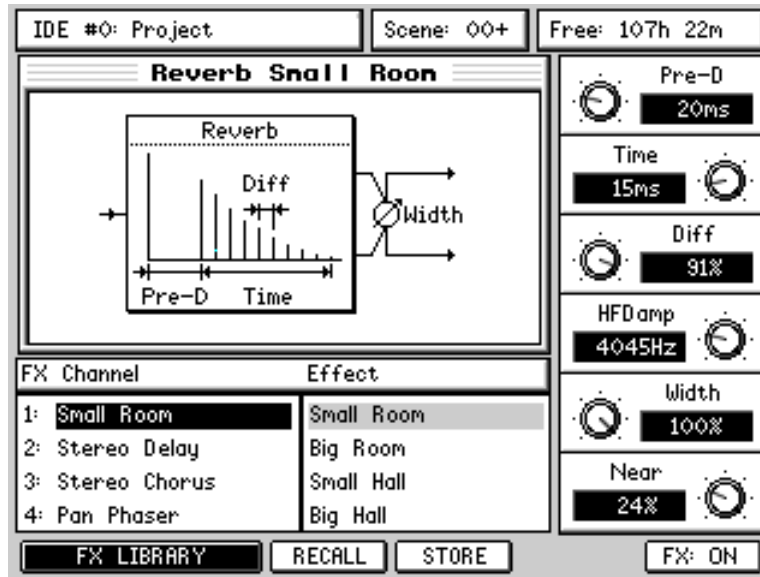

Here, you simply select the FX channel and the FX type with the cursor keys and set the parameters directly with the Q-LINK controls. Most of the DPS24's pages are like this and have no parameters to set via tedious cursor movement. There are a few pages, however, which have multiple parameters to select. One example is the CHANNEL page:

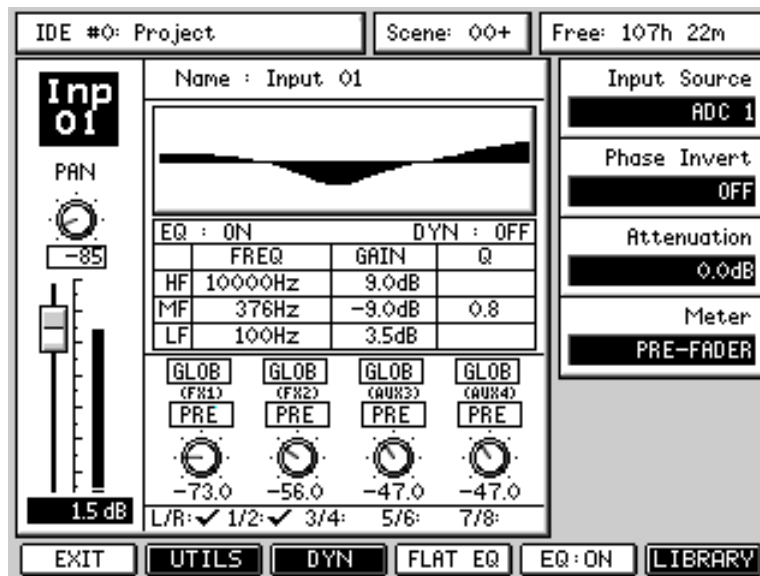

In a page such as this, you use the CURSOR keys to move around from parameter field to parameter field. You can also use Q5 as a quick cursor.



To edit the value you can.....

- Enter a number directly using the numeric keypad, followed by ENTER
- Use the numeric keypad's +/- keys to nudge values
- Use the Q6 as a typical DATA ENTRY encoder

In this example, however, you would probably prefer to use the Q-CHANNEL function to set the functions shown.

Some pages, however, have quite a lot of fields and unfortunately, there is no option but to cursor around them with the cursor keys or Q5, and use the numeric keypad's DATA +/- keys or Q6 to set values. An example of this would be the PATCH pages:

IDE #0: Project		Scene: 00+		Free: 107h 22m			
PATCH							
INPUT CHANNEL SOURCES							
1	2	3	4	5	6		
ADC1	ADC2	ADC3	ADC4	ADC5	ADC6		
7	8	9	10	11	12		
ADC7	ADC8	ADC9	ADC10	ADC11	ADC12		
DISK RECORD SOURCES							
1	2	3	4	5	6	7	8
GRP 1	GRP 2	GRP 3	GRP 4	GRP 5	GRP 6	GRP 7	GRP 8
9	10	11	12	13	14	15	16
GRP 1	GRP 2	GRP 3	GRP 4	GRP 5	GRP 6	GRP 7	GRP 8
17	18	19	20	21	22	23	24
GRP 1	GRP 2	GRP 3	GRP 4	GRP 5	GRP 6	GRP 7	GRP 8
FX RTN SOURCES							
FX1	FX2	FX3	FX4				
FX1 L+R	FX2 L+R	FX3 L+R	FX4 L+R				
OUTPUTS		GROUPS		L/R		PATCH PRESETS	

However, there are not that many pages like this and also, these are the kind of pages which, once set, do not require constant usage after that. For the most part, parameters are set using dedicated controls in the form of either the Q-LINK controls, the Q-STRIP/CHANNEL encoders of dedicated control surface switches.

## NAMING

It is possible to name things on the DPS24 from the front panel.

However, we thoroughly recommend that you connect a PS2 keyboard as this makes naming MUCH easier and suitable keyboards for the purpose can be bought very cheaply at any high street store that sells computers. Do not use a keyboard that requires a driver installation. Use only a keyboard that does not have special features such as Internet keys, Multimedia keys, built-in trackball. The simpler, the better. For instance, the BTC, 5106 costs only a few US dollars and works well with the DPS24.

When you go to name something, you will see this pop-up:

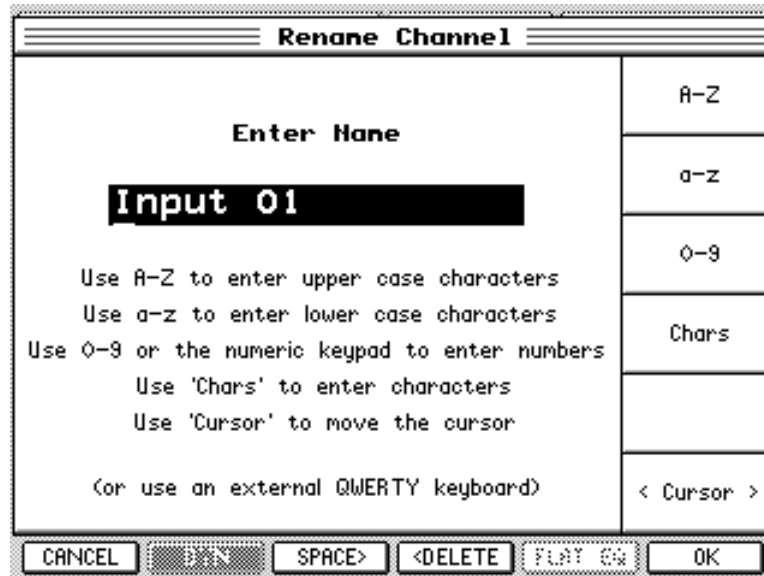

You can use Q1 to set upper case characters A-Z

You can use Q2 to set lower case characters a-z

You can use Q3 (or the numeric keypad) to enter numbers 0-9

You can use Q4 to enter the following special characters ! # \$ % & ' ( ) + , - ; = @ [ ]

You can use Q6 or the cursor keys to move the cursor left/right

You can use F3 to insert spaces

You can use F4 to backspace/delete

Press F6 or the ENTER key to confirm the new name and execute the current function.

Press F1 or the CANCEL key to abort name entry and return to the previous screen.

Whilst it is perfectly feasible to enter names in this way, we are the first to admit that it is nowhere

near as convenient as using an external keyboard.

## PROMPTS

The DPS24 uses prompts to guide you through certain function of the user interface.  
For example:



The DPS24 also uses progress displays for functions that take time.  
For example:

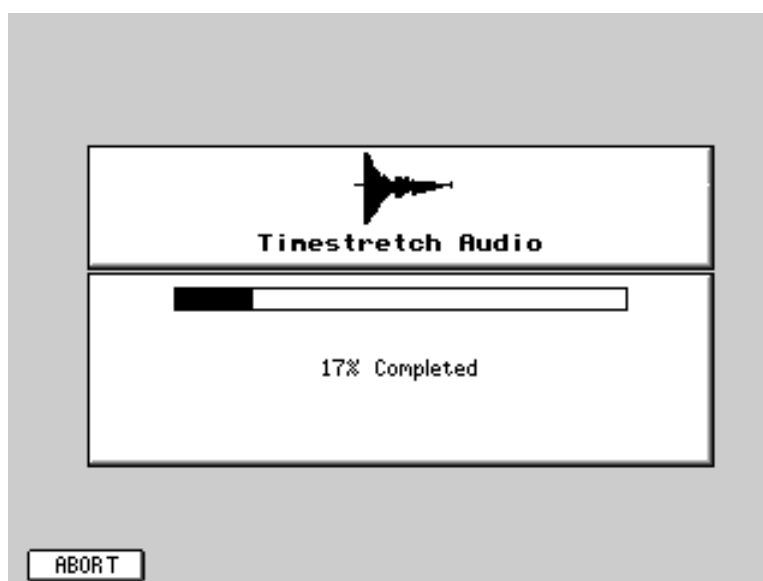

# MAIN CONTROL SECTION

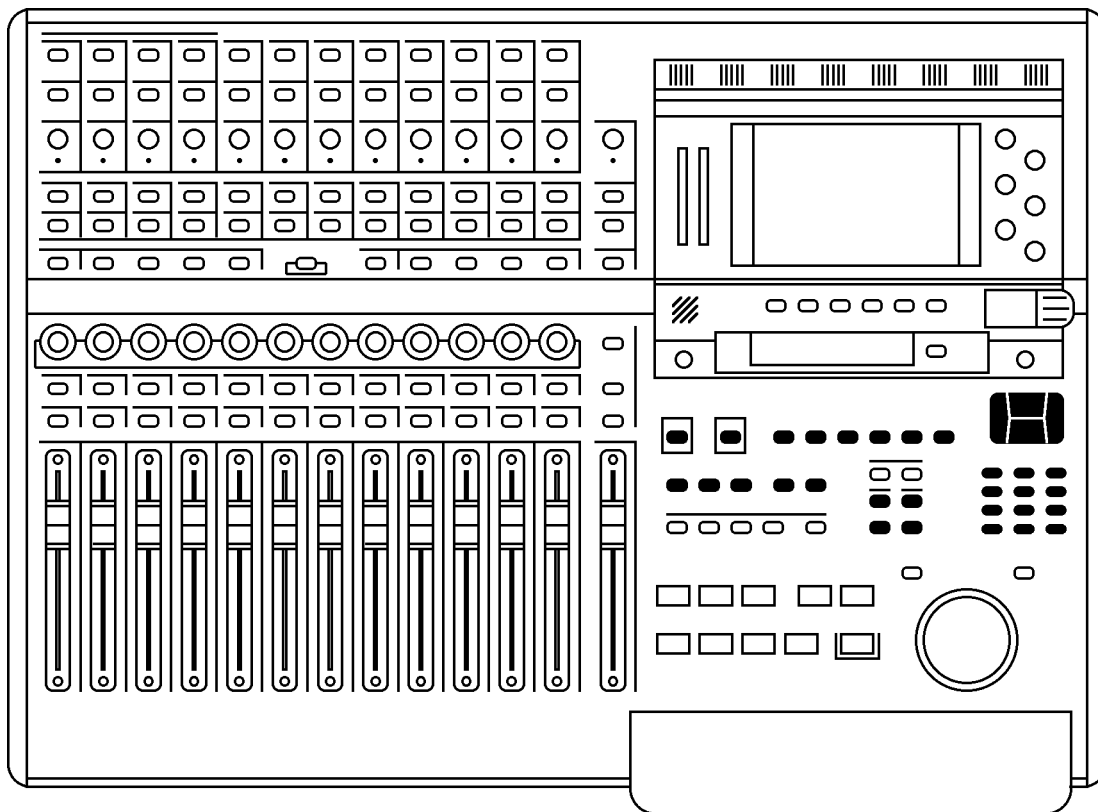

Here, you find the following functions:

- |             |  |
|-------------|--|
| EXT SYNC    | <p>This allows you to synchronize the DPS24 with external devices.</p> <p>When the key is pressed (and the LED illuminated), it enables the Time Sync synchronization setting (Master or Slave, MIDI or SMPTE).</p> <p>If Time Sync is set to MTC Slave or SMPTE Slave, the DPS24 will not play and/or record unless it is receiving external timecode.</p> <p>If Time Sync is set to MTC Master or MIDI Clock Out, sync will not be sent to the MIDI output unless the EXT SYNC key is enabled.</p> <p>It's SHIFT function allows you to set a timecode offset.</p> |
| MAIN SCREEN | <p>This is the main operating screen that one normally works in.</p> <p>It shows the project name, meters and an overview of the project.</p> <p>It's SHIFT function (GRID) shows an enlarged project display.</p>   |
| EDIT        | <p>Allows you to edit audio with functions such as copy, cut, paste, etc..</p> <p>This mode's SHIFT function gives access to the DPS24's off-line DSP functions such as timestretch, pitch shift, etc..</p>  |
| MIXER       | <p>Allows access to Mixer and Channel views, Solo and FX/AUX setup.</p> <p>Its SHIFT function shows the PATCH pages where you may route signals within the DPS24.</p>  |
| AUTOMATE    | <p>Provides access to the DPS24's automation functions.</p>  |
| FX          | <p>Takes you to the effects pages where you may select and edit the DPS24's internal effects.</p>  |

- PROJECT Allows you to load, create, delete, copy, backup and restore Projects. Its SHIFT function (V.TRACK) gives access to the 'Virtual Tracks' function.
- SETUP Allows you to set global parameters that affect the DPS24 as a whole. Its SHIFT function allows access to the CD-R functions for mastering to and playing back from the (optional) CD-R.
- CURSOR Allows you to move around the screen where applicable. Its SHIFT function allows you to zoom in horizontally and/or vertically on track and/or waveform displays in certain modes.
- SHIFT Accesses certain keys' sub-functions labelled in white below the key.
- UNDO/REDO These keys allow you to undo and redo operations. 20 undo/redo operations are possible. If the "UNDO Confirm" parameter in SETUP / PREFERENCES is ON, a temporary confirmation pop-up message will be displayed. If there is nothing to undo / redo, a prompt will inform you as such.
- PRE-ROLL The PRE-ROLL key allows you to add an offset to locate points and CYCLE loops. When switched on, any locates you do will be to the locate point minus the pre-roll. For example, with a pre-roll of 5 seconds, if you locate to a memory point of 00:01:00:00, the DPS24 will actually locate to 00:00:55:00.

It's SHIFT function allows you to set the PRE/POST-ROLL times:

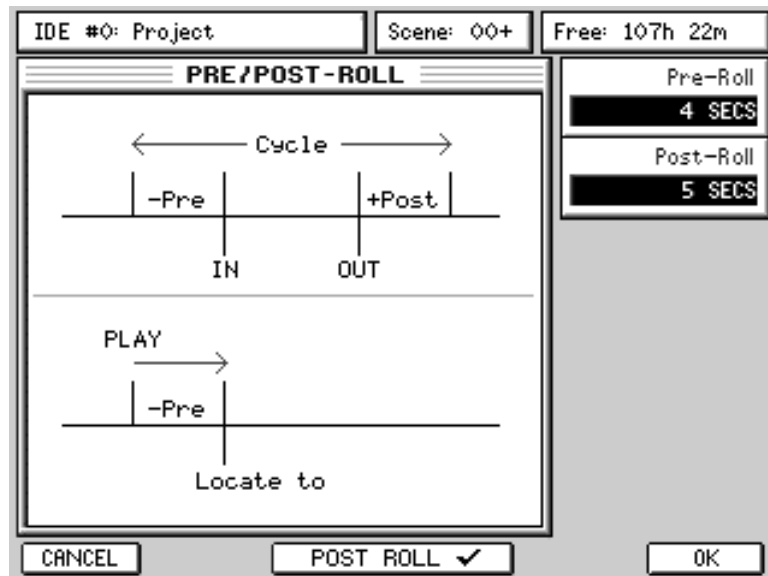

The parameters are:

- PRE-ROLL Sets the pre-roll time
- POST-ROLL Sets the post roll time (if enabled on F3/4)  
POST-ROLL can be optionally enabled using F3/4.  
If enabled, switching PRE-ROLL on will also switch on post-roll.

**AUTO** Activates the AUTO record function. When AUTO is switched on, monitoring switches from disk to input at the IN time on the selected track(s) and switches back to disk playback at the OUT point. Thus you can rehearse the recording simply by switching AUTO on.

By pressing RECORD and PLAY before the IN point, however, the project will play up to the IN point monitoring off disk, will switch to input and drop into record at the IN point up until the OUT point where it will drop out of record and switch back to monitoring off disk.

Used in conjunction with the PRE/POST-ROLL function and CYCLE, you can cycle round the IN/OUT points with the PRE-POST-ROLL offsets to repeatedly rehearse a take - when you ready, press PLAY+RECORD (or the footswitch) to commit the recording.

For example, if the IN time is set to 00:01:00:00 and the OUT time is set to 00:01:20:00, with PRE-ROLL and POST ROLL set to 5 seconds each, with CYCLE switched on, the DPS24 will play around 00:00:55:00 to 00:01:25:00 switching monitoring/punching in/out at 00:00:01:00 and 00:01:20:00 respectively.

To hear the recording, you should switch AUTO off.

**INP MON** Switches selected inputs to monitor. When INPUT MONITOR is switched off (the default), monitoring is as follows on the selected RECORD tracks:

PLAYBACK	Monitor disk
RECORD	Monitor input
STOP	Monitor input

Thus, when playing up to a record punch-in (manual or automatic), you hear the track(s) selected for record playing back. At the point of the punch-in, monitoring switches to INPUT and you will hear what you are playing/recording. At the point of punch-out, monitoring reverts to disk playback. When playback is stopped, you hear the inputs. When Jog/Shuttle mode is active (green PLAY LED lit), the DPS24 is in Playback mode, therefore monitor is on disk tracks, not inputs.

When INPUT MONITOR is switched on, you hear the inputs through the tracks selected for record at all times (i.e. during playback, recording and when the DPS24 is stopped).

**WHEEL** Turns the JOG/SHUTTLE wheel on or off.

**CANCEL** Cancels/aborts prompt driven actions (for example, editing, deleting, naming, scene recall, autolocate recall, etc.).

**ENTER** Proceeds with any prompt driven actions about to take place (for example, editing, deleting, naming, scene recall, autolocate recall, etc.).

**NOTE:** Cancel and Execute are also shown on the LCD in such circumstances. The dedicated keys are provided for convenience when using functions such as scene and/or autolocate recall, etc., where it may not be convenient to reach up to the LCD.  
In most LCD pages, CANCEL duplicates as F1 (EXIT/CANCEL) and ENTER as F6 (OK, PROCEED, ...).

# MIX SCENE KEYS

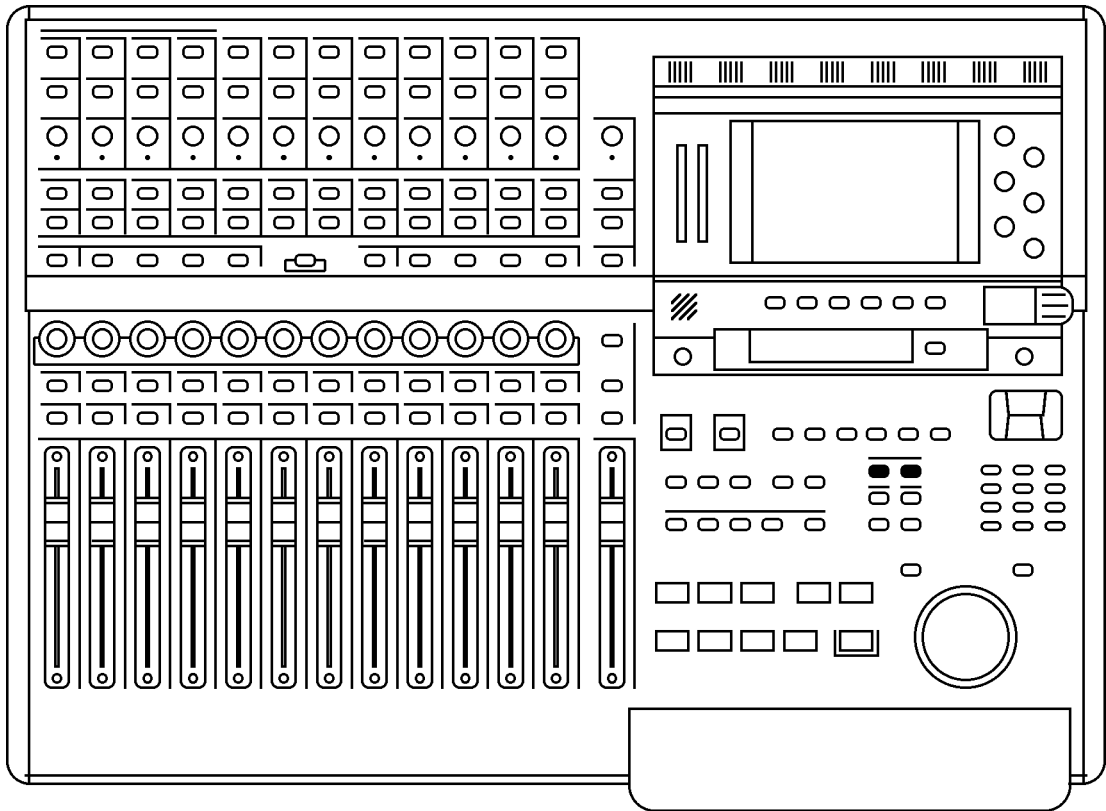

In a single DPS24 project, you can store and recall up to 100 'Mix Scenes'. These are 'memories' of the whole mixer's settings such as EQ, fader position, FX sends, etc.. for all Channels. The following table shows what is and isn't stored in Mix Scene:

SAVED	NOT SAVED
FADER	INPUT A/B STATUS
PAN POSITION	INPUT TRIM SETTINGS
CHANNEL ON/OFF	MIC/LINE SELECTION
FX/AUX SEND LEVELS	MONITOR LEVEL
FX/AUX ROUTINGS	MAIN/NEAR STATUS
GROUP ROUTINGS	MONO MONITOR SWITCH STATUS
L/R ROUTING	TALKBACK BUTTON STATUS
EQ	TALKBACK LEVEL
DYNAMICS	SOLO STATUS
INPUT SOURCE	RECORD PATCHING
CHANNEL LINK	OUTPUT PATCHING

Also saved in a Mix Scene are Global FX/AUX Setup and FX selection and settings for all 4 Effects. Scenes are recalled using the SCENE RECALL key and are stored, not surprisingly, using the SCENE STORE key.

The MIX SCENE STORE and RECALL keys are also used to store and recall EQ or DYNAMICS SNAPSHOTS for individual Mixer Channels, and FX SNAPSHOTS for individual effects channels. SNAPSHOTS are explained later in this manual.

## STORING A MIX SCENE

To store a mix scene, press STORE (the key will flash). You will see something like this pop-up prompt:



You should use the CURSOR keys to move up or down the list of available mix scenes to select an 'unused' mix scene if you want to store a new scene. If you press the flashing ENTER key or STORE [F6], the scene will be stored..

However, if you know the number of the next unused mix scene, you can simply type that two-digit number (02, 22, 54, whatever) followed by ENTER or STORE [F6]. Again, the scene will be stored and will use the default name "SCENE nn (where nn is the scene memory number).

If you know the number of a mix scene you would like to overwrite, type the number on the numeric keypad and press ENTER/STORE. The scene will be stored with the original name.

It is also possible to name scenes using NAME+STORE [F3/4]. Pressing this will pop-up the usual naming prompt and you can name the scene as appropriate. If the scene memory is an existing one, the new name will overwrite the original.

You can also rename an existing scene using RENAME [F5].

You will note the extra parameter at the bottom of the prompt window. This allows you to select exactly what will be stored. You can select the following options:

- |             |  |
|-------------|--|
| ALL         | Everything will be stored in the selected scene - fader position, pan positions, FX/Aux send settings, channel on/off status, EQ and FX settings.  |
| STATIC ONLY | Only static controls such as EQ and FX settings will be stored. The faders, pans and FX settings (i.e. those that can be dynamically automated) will not. This allows you to recall different EQ settings on one or more channels and also switch different effects as the track plays.  |
| NO FADERS   | Everything except the faders will be stored. This allows you to set the mix parameters such as pan, FX/Aux sends, EQ and FX and regard them as 'static' controls without your dynamic fader mix being affected. Perhaps the best way to use this option is to set RECORD EVENTS to FADER in the AUTOMATION page and mix your project using the faders using this option to store different pan, FX/Aux settings, EQ, etc., as 'static' controls. |

To select these options, use the adjacent Q5 Q-link control.



## RECALLING A MIX SCENE

To recall a mix scene, if you know the scene number you want to use, recalling a scene is simply a matter of pressing RECALL (the key will flash), typing in a two-digit number (00-99) on the adjacent numeric keypad followed by pressing ENTER (which also flashes when RECALL is pressed). The scene will be recalled.

When you press RECALL, a pop-up is also shown on the LCD:

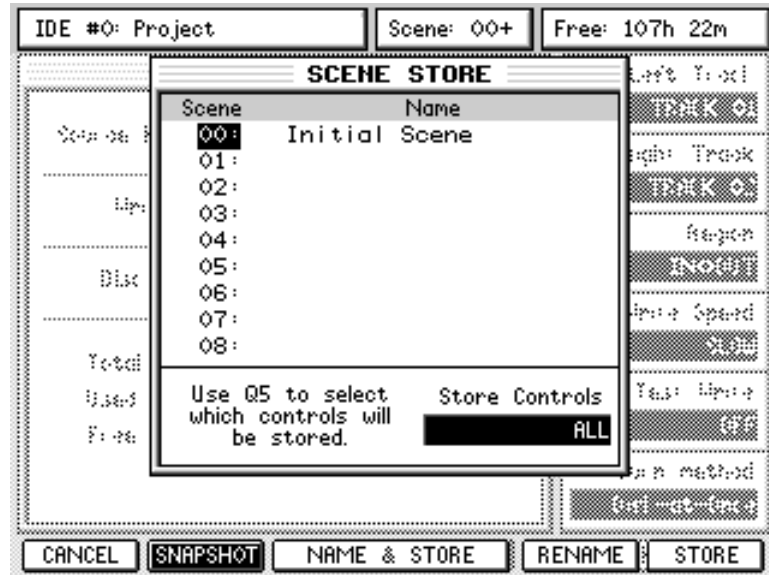

As well as the numeric keypad, you can use the CURSOR UP/DOWN keys to move through the list and you can press the ENTER key or F6 - RECALL - to recall the selected scene. The prompt will close when the scene is recalled.

When recalling a scene, you can also decide what will be recalled. For example, you may have stored Scene 03 as ALL (everything stored) but when you come to recall that event, you can decide to only recall (for example) static controls.

As with STORE, use Q5 to select what it is you want to recall (e.g. ALL controls, STATIC controls or NO FADERS) and press ENTER or RECALL [F6]. The scene will be recalled but, depending on the complexity of your mix or the settings being recalled, it can take a second or two for the recalled settings to take effect.

Pressing F3 or F4: RESET MIXER resets the mixer to its default configuration.

The default mixer settings applied when RESET MIXER is used are as follows:

- Faders / Mute:
  - INPUTS: 0dB, CH ON
  - TRACKS: 0dB, CH ON
  - GROUPS: 0dB, CH ON
  - FX RETURNS: 0dB, CH ON
  - FX/AUX SENDS: 0dB, CH ON
  - AUX IN: -120dB, CH ON
  - MASTER: 0dB,
  
- Pan: All Pan centered
  
- All Mono Channels (INPUTS and TRACKS):
  - EQ ON, FLAT EQ
  - DYN OFF
  - SENDS 1-4: GLOB, POST, -120dB
  
- FX RTN Channels:
  - SENDS 1-4: OFF, POST, -120dB
  
- L/R ASSIGN:
  - TRACKS and FX RTNS: L/R
  - INPUTS and GROUPS: "---" (not assigned)
  
- GROUP ASSIGN: all signals "---" (not assigned)
  
- FX/AUX SETUP:
  - 4 x MONO
  - FX 1-4
  
- MIDI CHANNELS:
  - Fader: OFF, Controller 007, default value=104
  - Pan: OFF, Controller 010, default value=64
  
- FX:
  - MBCX: OFF
  - FX1: ON, Big Hall
  - FX2: ON, Stereo Delay
  - FX3: ON, Stereo Chorus
  - FX4: ON, Pan Phaser
  
- INPUT ROUTING:
  - INPUT SOURCES: ADC 1-12
  - FX RTN SOURCES: FX 1-4 L+R

Pressing RESET MIXER will reset the entire mixer to 'flat' according to the option selected in RECALL CONTROLS as follows:

ALL	Will reset all controls (faders, pans, sends, EQ, channel dynamics channel on/off, FX/MBCX settings, etc.)
STATIC ONLY	Will reset all static controls (EQ, channel dynamics, FX/MBCX settings)
NO FADERS	Will reset all controls except the faders It is also possible to automate scene recalls - that is, as the dynamic automation is running, scenes can be recalled at any time as part of the automation. Recalling a scene recalls all the selected parameters (ALL, STATIC or NO FADERS) for all Mixer Channels and all FX channels.

EQ, DYNAMICS and FX Snapshots recall can also be automated for individual channels. SCENE and SNAPSHOT automation is described later in this Manual in the AUTOMATION section.

#### **IMPORTANT NOTE ABOUT SCENE 00 : INITIAL SCENE**

*The DPS24's dynamic mixer automation uses Scene 00 as its reference point. If the automation is switched ON, whenever you press PLAY at any point in the project, the automation refers to Scene 00 so that it knows where it should be and what automation data it should be playing.*

*This means that Scene 00 sets the initial mix settings for the project. If you subsequently change any of the parameters that are not dynamically automated, these will be reset to Scene 00's settings when you press play.*

*As an example, Scene 00 in your project has all channels' EQ set 'flat' (i.e. no EQ applied).*

*Someway through the project, however, you adjust one channel's EQ. When you press PLAY, that channel's EQ will be reset to the settings stored in Scene 00. Another example is that you set a pair of channels to be linked as a stereo pair at some point and set each channel's pan position to hard left and right respectively - when you press PLAY, if that link and the pan positions have not been saved into Scene 00, they will be reset.*

*In other words, if you make a change that you like to any parameters that are not dynamically automated, ensure that you store the changes in Scene 00 so that they are recalled with the dynamic automation.*

## TRANSPORT KEYS

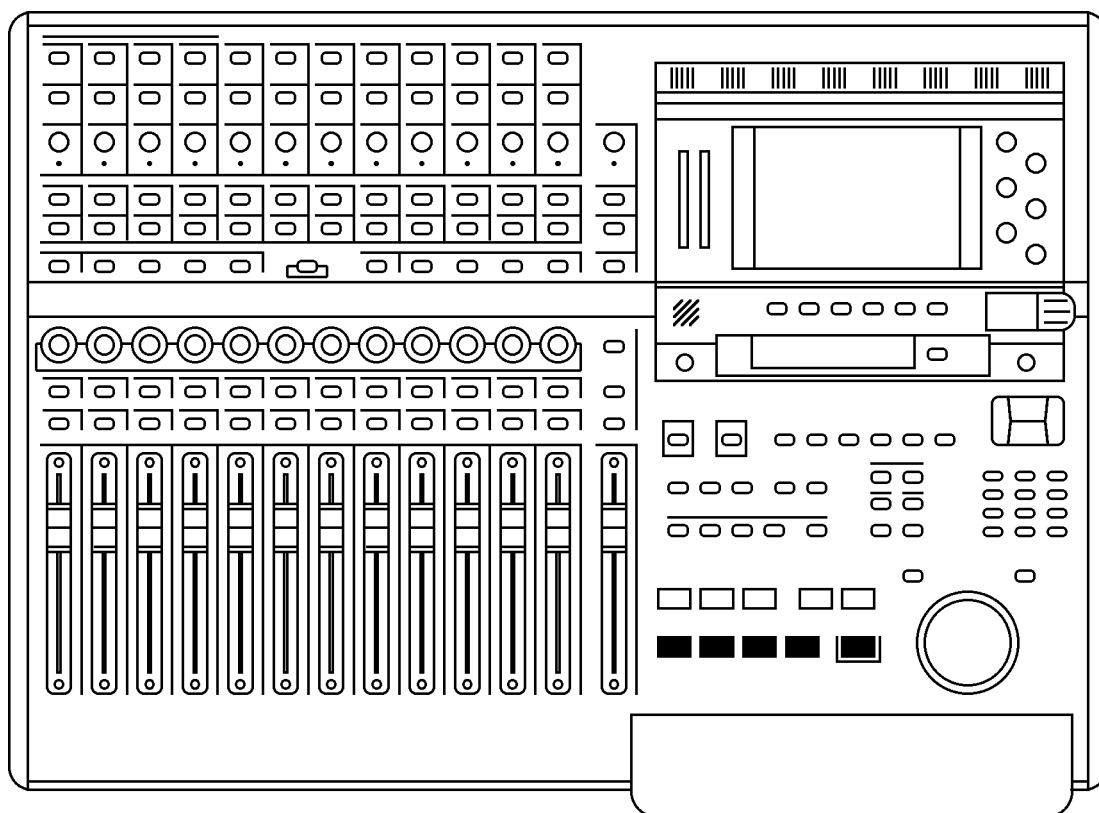

A standard transport key layout is provided. The functions are:

- |              |   |
|--------------|---|
| REWIND       | Rewinds the project at x10 normal play speed.   |
| FAST FORWARD | Fast forwards the project at x10 normal play speed.<br><br>Pressing <b>REWIND</b> or <b>FAST FORWARD</b> when a project is playing will rewind or fast forward it at x5 speed with 'tape chatter' as on an analogue reel-to-reel.<br><br>This can be changed in <b>SETUP / PREFERENCES</b> by setting the "Shuttle X5 mode" parameter from "LATCHED" to "MOMENTARY", as described later in this manual.   |
| STOP         | Stops playback, rewind, fast forward, etc..   |
| PLAY         | Plays the selected project. Pressing <b>PLAY</b> whilst recording will cause the DPS24 to drop-out of record.   |
| RECORD       | This allows you to record. To drop into record whilst the project is playing, press and hold <b>PLAY</b> and then simultaneously press <b>RECORD</b> (i.e. like a normal MTR). You can also start recording from stopped - press and hold <b>RECORD</b> and simultaneously press <b>PLAY</b> . Recording will begin as soon as playback commences.<br><br>To drop out of record, simply <b>PLAY</b> or <b>STOP</b> .<br><br>You can also abort recording at any time by pressing <b>SHIFT+RECORD</b> . This will drop out of record and will delete the recording from the project and from disk. |

## EDIT PLAY KEYS

Above the main transport keys are special 'edit play' keys to audition edit points:

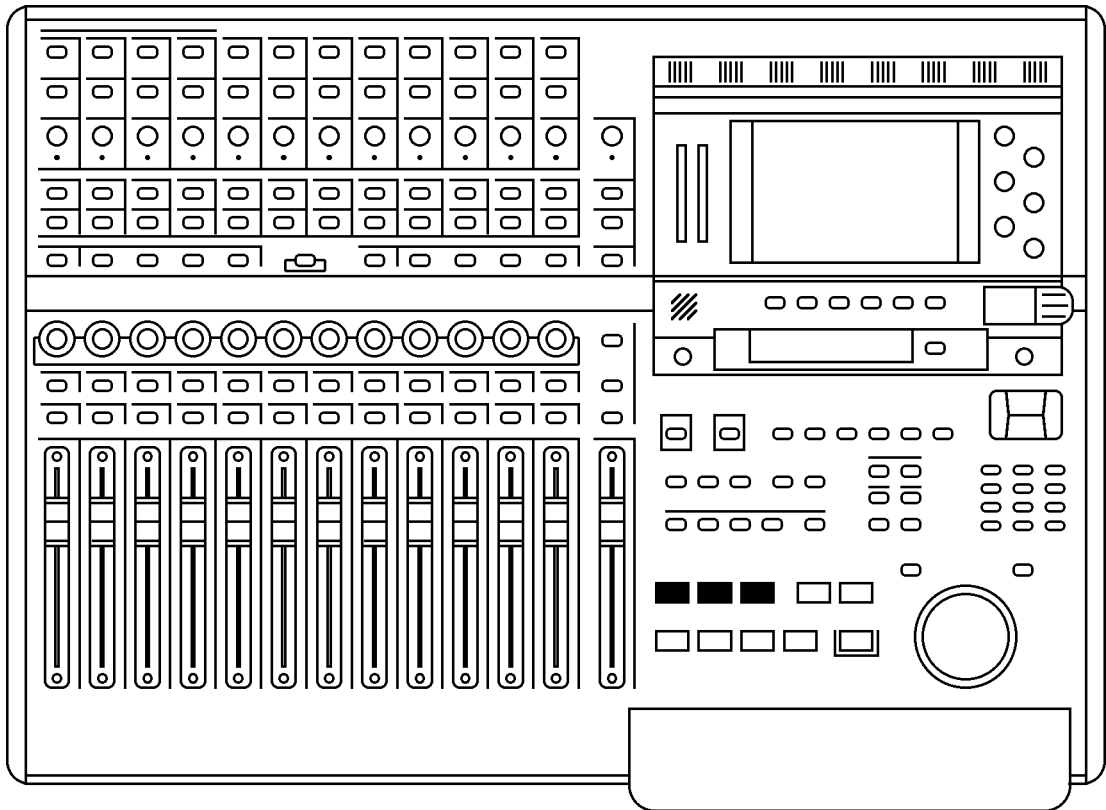

From the current NOW time (original location), their functions are:

TO	Rolls-back, plays up to the original location and stops. The play-to time can be set in the SETUP / PREFERENCES mode.
FROM	Plays from the current NOW time and returns to the original location. The play-from time can be set in the SETUP / PREFERENCES mode.
PLAY OVER	Pressing TO and FROM together plays over the current NOW time and returns to the original location. The to/from time depends on the value set for PLAY TO and PLAY FROM in the SETUP / PREFERENCES mode.
IN>OUT	Plays between the IN/OUT markers and returns to the original location. It's SHIFT function - LOOP - allows you to play the IN/OUT region repeatedly in a seamless loop and is useful for auditioning how an edit may sound when played repeatedly (i.e. when pasted or inserted several times end-to-end).

*NOTE1: When using the edit play keys, any automation data is ignored. When the regular PLAY key is pressed playback commences, however, the automation data will be played back.]*

*NOTE2: When using the edit play keys while AUTO is enabled, the 'rehearse' auto-monitoring does not apply. This way, it is possible to playback the last recording using the IN>OUT key, without disabling the AUTO mode.*

## AUTOLOCATOR

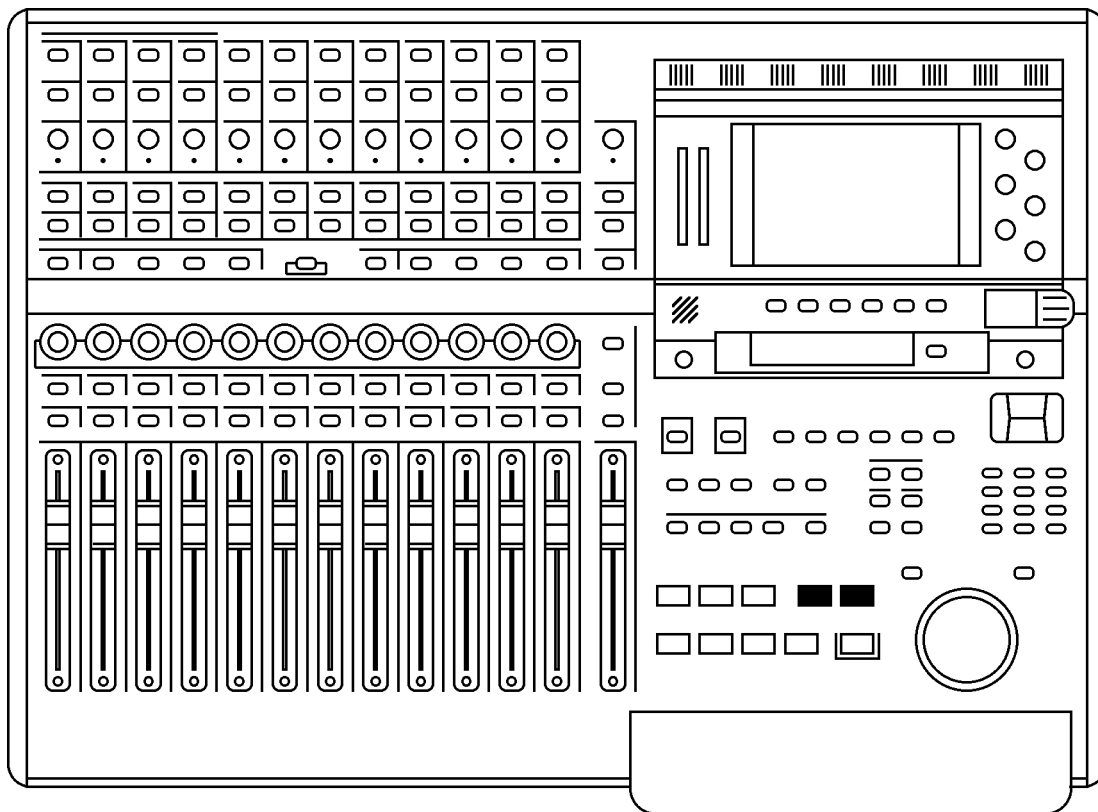

Next to the EDIT PLAY keys are the AUTOLOCATE keys:

Their functions are:

- |        |   |
|--------|---|
| GOTO   | Pressing this key allows you to locate to one of 100 (00-99) previously stored locate memory points, to the IN/OUT points, to the Project START / END, to the PREVIOUS / NEXT cue, return to zero, or roll-back by the pre-roll time. |
|        | Pressing SHIFT+GOTO pops up a window that allows you to enter a locate time value with the numeric keypad.  |
| MEMORY | Pressing this key allows you to store a locate point.   |

## USING THE AUTOLOCATOR

To store a locate memory, the basic operation is as follows: press the MEMORY key followed by a two-digit number followed by ENTER. This will store the current NOW time into the selected locate memory.

Although the STORE function is designed to be used 'blind' without referring to the LCD, when you press MEMORY, this pop-up is shown:

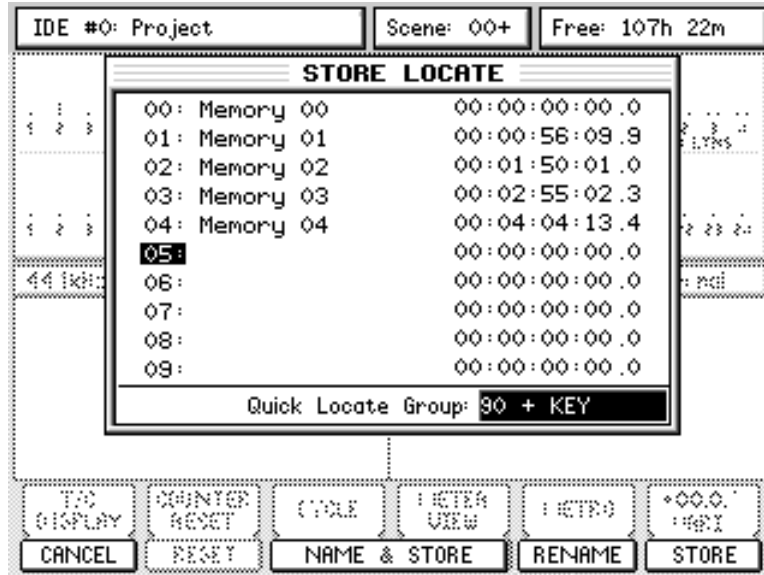

Using this list, instead of entering the two-digit memory number, you can use the CURSOR UP/DOWN keys or the Q6 knob to scroll and select a locate memory number to store.

The NOW time is captured at the time when you press F6, STORE or the ENTER key.

By default, the stored locate point is named "Memory nn", however, you may also name the locate point before storing it by pressing F3/F4, NAME & STORE. IN that case, the NOW time is captured at th etime when you press F6, OK in the Name Locator window.

Storing the locate memory also closes the prompt. You can also close the pop-up without storing a locate memory by pressing F1, CANCEL or the CANCEL key,

If you have stored a memory, the next time that you will enter the STORE LOCATE pop-up, the cursor will automatically be positionned on the next memory number.

While the STORE pop-up is open, you can also rename existing memories by placing the cursor on the memory number to rename and pressing F5, RENAME.

Once stored, they may be recalled using the GOTO key .

Although the GOTO function is designed to be used 'blind' without referring to the LCD , when you press GOTO, a prompt is also shown on the LCD:

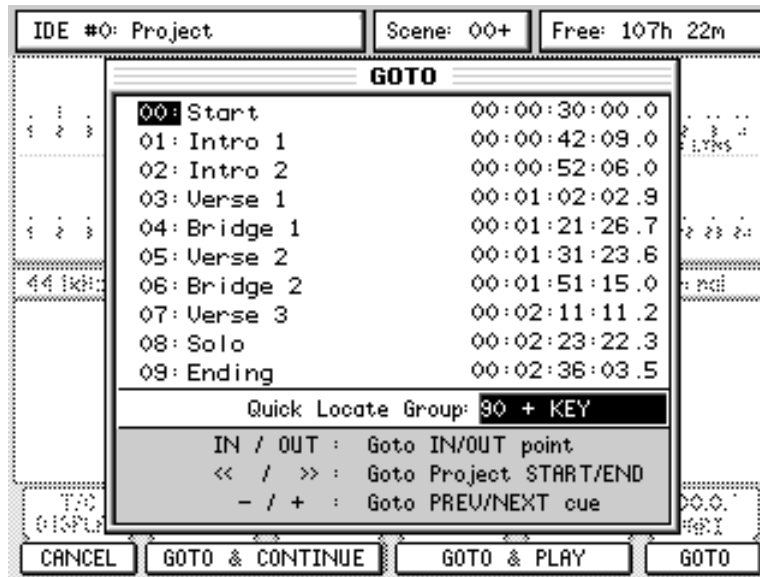

You can.....

- Press GOTO followed by IN to locate to the IN point and stop
- Press GOTO followed by OUT to locate to the OUT point and stop
- Press GOTO followed by REWIND to locate to the start of a project and stop
- Press GOTO followed by FAST FORWARD to locate to the end of a project and stop
- Press GOTO followed by STOP to locate to zero and continue
- Press GOTO followed by PLAY to roll-back by the pre-roll time and continue
- Press GOTO followed by - to locate to the previous Cue and stop
- Press GOTO followed by + to locate to the next Cue and stop
- Press GOTO and use the NUMERIC keypad to type in a 2-digit locate memory number followed by ENTER or GOTO [F6] or GOTO & PLAY [F4/F5] or GOTO & CONTINUE [F2/F3]
- Press GOTO and use the CURSOR UP/DOWN keys or the Q6 knob to select a memory to locate to followed by ENTER or GOTO [F6] or GOTO & PLAY [F4/F5] or GOTO & CONTINUE [F2/F3]

Pressing ENTER or GOTO [F6] will simply locate to the memorised point, minus pre-roll time if PRE-ROLL is enabled.

The function works whether the project is playing or not. If the project is playing, pressing GOTO will locate to the selected memory and stop there.

However, pressing GOTO+PLAY (F4/F5) will locate to the selected memory and will automatically put the DPS24 into play.

Pressing GOTO & CONTINUE [F2/F3], playback will continue with the previous transport state.

So, for example, if you are in play at 5x speed, after locating with GOTO & CONTINUE, the DPS24 will start playing again at 5x speed after locating to the specified point.

Whichever key you press to locate, the prompt closes when you press it.



## QUICK LOCATE KEYS

To facilitate easier locating, 'quick keys' are also available.

It is possible to use the numeric keypad 0-9 as Quick Locators without opening the GOTO/MEMORY windows.

To Store Quick Locates, press and hold MEMORY and press a numeric key 0 - 9.

To Recall Quick Locates, press and hold GOTO and press a numeric key 0 - 9.

If you press (and hold) either MEMORY or GOTO but don't press a numeric key, upon releasing either key (MEMORY or GOTO), the usual locator pop-up will be shown on the LCD as shown above.

**NOTE:** The new QUICK LOCATE function uses locator memories 90-99 as the default on the assumption that these are unlikely to be actually used as 'real' locator memories. Operation should be transparent. However....

By pressing GOTO or MEMORY, you can use Q5 to select which group of 10 locate memories will be used for the QUICK LOCATE memories. These can subsequently be used as 'quick locates'.

So, for example, if you have a bunch of useful locate points in Locate memories 50-59, these can be nominated as your 'quick locate' memories.

## GOTO NEXT / PREV CUE

Another option allows you to locate to the next or previous 'cue' without opening the GOTO/MEMORY windows.

This is a quick way of moving around a project where locate markers have not been set. To go to the next and previous cues, press and hold the GOTO key whilst pressing the numeric keypad +/- keys.

However, there is a certain logic to the function that needs to be understood.

When no tracks are selected for EDIT, pressing GOTO and + will simply go to the start and then the end of every cue on every track. For example:

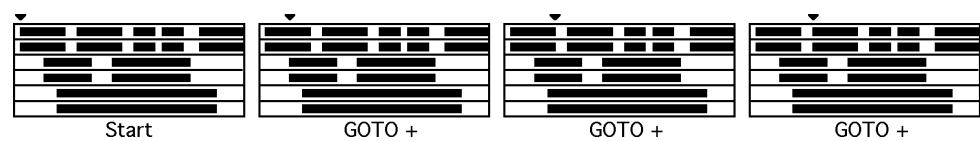

And so on.

However, with (say) tracks 1 and 2 selected for EDIT, GOTO +/- will only go to the start and end of the cues on the selected track(s):



And so on.

Of course, in all cases, GOTO - has the opposite effect.

Furthermore, in the MAIN SCREEN / GRID and the main EDIT / DSP mode pages, you can use SHIFT + Q5 to move between the next and previous cues. In this way, you can skip through a project very quickly.

## LOCATE TO TIME

You can also locate to a specific timecode position by pressing SHIFT+GOTO. This will pop up a prompt where you can enter the timecode value using the numeric keypad:

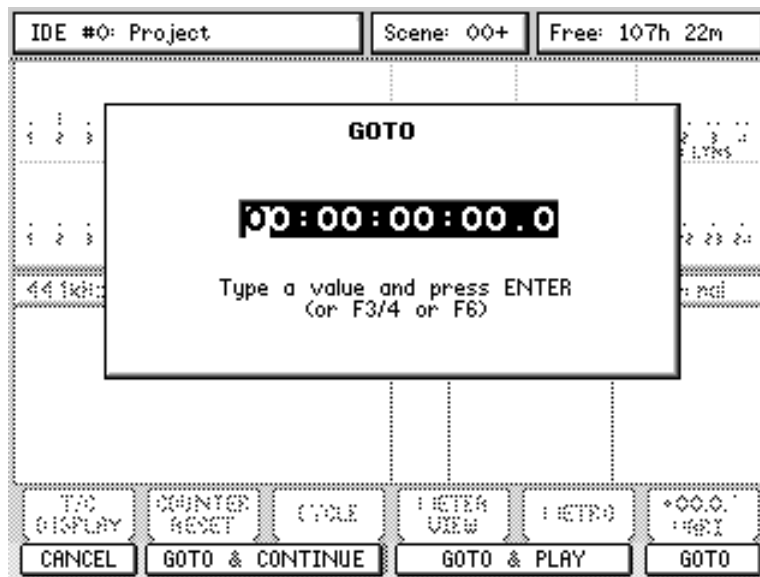

If DISPLAY SELECT is set to BARS/BEATS/CLOCKS instead of Time Code, you can enter the locate time in Bars and Beats.

## JOG/SHUTTLE WHEEL

The DPS24 features a combined JOG/SHUTTLE wheel:

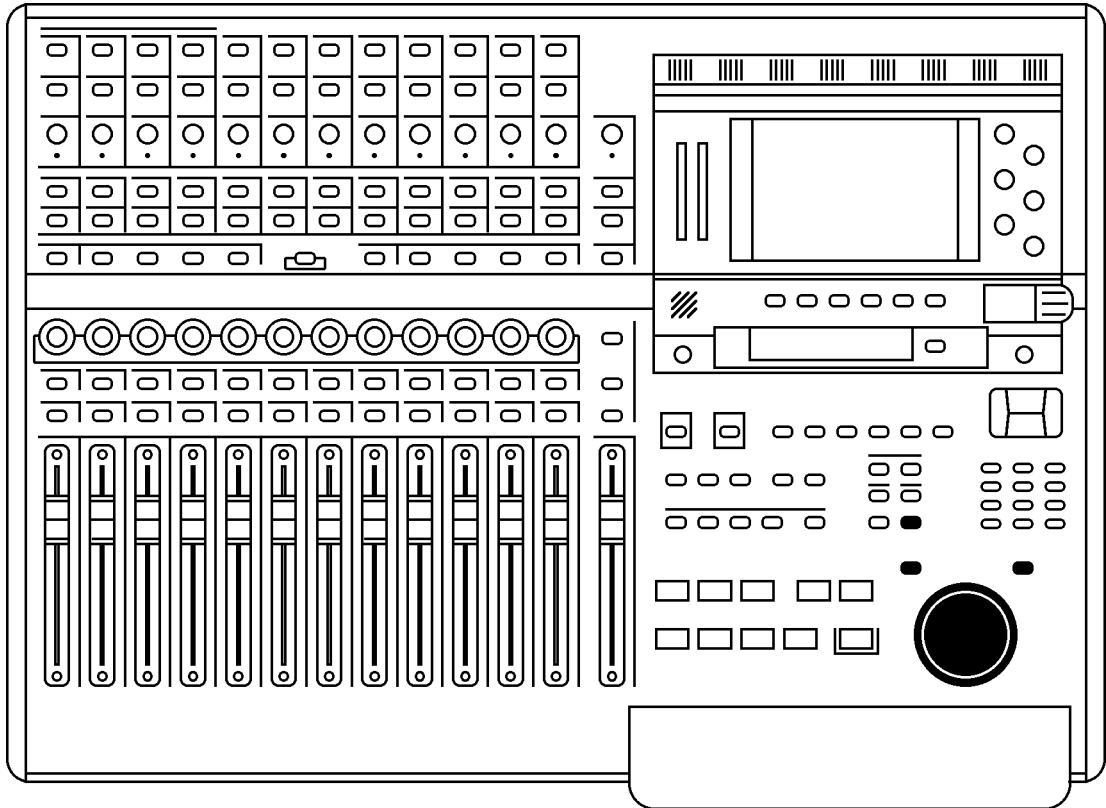

The outer shuttle wheel allows variable speed playback forward or backward at 2 x nominal speed whilst the inner jog wheel allows you to scrub audio. It is possible to scrub all 24 tracks.

**NOTE:** When shuttling or jogging, any automation data is ignored. When forward playback commences, however, the automation data will be played back.

The entire wheel mechanism can be switched off using the WHEEL key located above the IN key to prevent accidental use during critical playback (for example, when doing the final mixdown).

When WHEEL is switched ON, however, you can grab the jog wheel at any time during playback to scrub audio and identify edit points, locate points, etc..

**NOTE:** During critical playback (live shows, etc), it is recommended to switch WHEEL OFF to avoid possible interruptions caused by unintentionally moving the Jog/shuttle wheel.

## IN/OUT KEYS

Pressing either of these keys marks the current NOW time as the IN or OUT points. IN and OUT points can be marked 'on-the-fly' even when a project is playing - there is no need to have to stop playback to mark an edit point or create an edit region.

When an IN/OUT region is marked, it is highlighted on the track display of the LCD.

You can immediately audition the IN/OUT region by using the IN>OUT/LOOP special play key.

**NOTE:** Although it is possible to place the OUT time before the IN time, if you attempt any kind of audio edit or offline DSP process, you will be prompted that it is an invalid edit region. In other words, when using the IN and OUT keys for editing, the IN time must always be before the OUT time.

## POWERING UP THE DPS24

Ensuring that you monitor amplifier's master level control is turned down, switch the DPS24 on using the rear panel POWER switch. You will see this screen during power up:

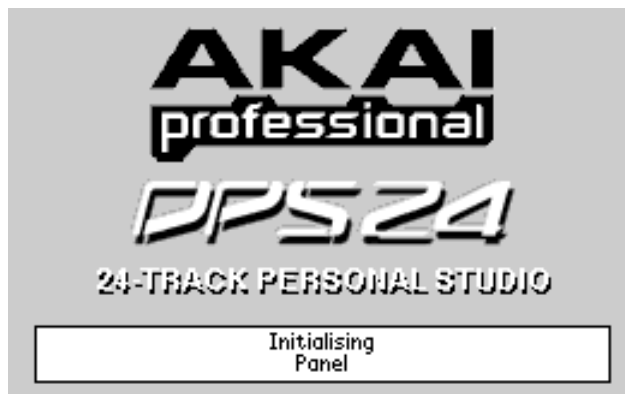

Followed shortly afterwards by this screen:



Once the disk scan has completed, you should see the icons for the installed drive(s) appear at the bottom of the screen. Typically, these will be the Internal HD and maybe a CD drive (if the option is installed).

**NOTE:** If your LCD appears blank during power up, check to make sure that the LCD CONTRAST control is not set to minimum. The contrast can be turned down such that the screen can appear almost completely blank from some viewing angles.

If your DPS24 does not power up as described above - for example, you get an error message saying "NO DRIVES DETECTED" or your CD drive (if installed) doesn't show up at the bottom of the screen or whatever - you should contact your Akai Professional dealer or technical support immediately.

Assuming your DPS24 does power up properly, you should press MAIN (or whichever mode) you wish to use.

# DPS24 MODES

Running below the LCD are the DPS24's 'mode' keys:

These are:

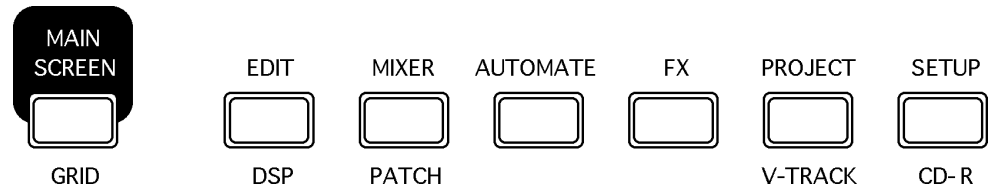

## MAIN SCREEN

This is the main operating screen that one normally works in. It shows meters for all mixer channels and an overview of the active project, as well as current Project setup information (Sample rate, Bit depth, Frame rate).

Its SHIFT function shows an enlarged project display, GRID.

## EDIT

Allows you to edit audio with functions such as copy, cut, paste, etc..

Audio Import/Export functions are also available from the EDIT mode.

Its SHIFT function gives access to the DPS24's off-line DSP functions such as timestretch, pitch shift, etc..

## MIXER

Allows access to mixer and channel views, as well as mixer Solo and FX/Aux setup.

Its SHIFT function shows the PATCH pages where you may route signals within the DPS24 (although most of this can be achieved directly from the front panel).

## AUTOMATE

Allows you to set mixer automation functions.

## FX

Takes you to the effects pages where you may select and edit the DPS24's internal effects.

## PROJECT

Allows you to load, create, copy, backup/restore, delete or rename projects.

Its SHIFT function gives access to the 'Virtual Tracks' function.

## SETUP

Allows you to set global parameters such as timecode and digital sync options, preferences, etc., that affect the DPS24 as a whole.

Its SHIFT function allows access to the CD-R functions for backing up to, mastering to and playing back from the (optional) CD-R.

One powerful aspect of the DPS24's operation is that you do not have to stop playback (or whatever else you may be doing) to access the different modes or other functions on the unit. Thus, you can be recording and perhaps during record, switch to AUTOMATE mode to set some automation parameters up in advance. You could be playing back and switch to EDIT mode to start editing tracks. Similarly, you can be playing back and enable the Q-Channel to tweak a channel's EQ whilst at the same time, switching to the FX mode to set effects.

In other words, the DPS24's operating system need not get in the way of your creative flow forcing you to stop what you are doing in order to do something else.

# MAIN SCREEN

When a project is loaded, pressing the MAIN SCREEN key will show this screen:

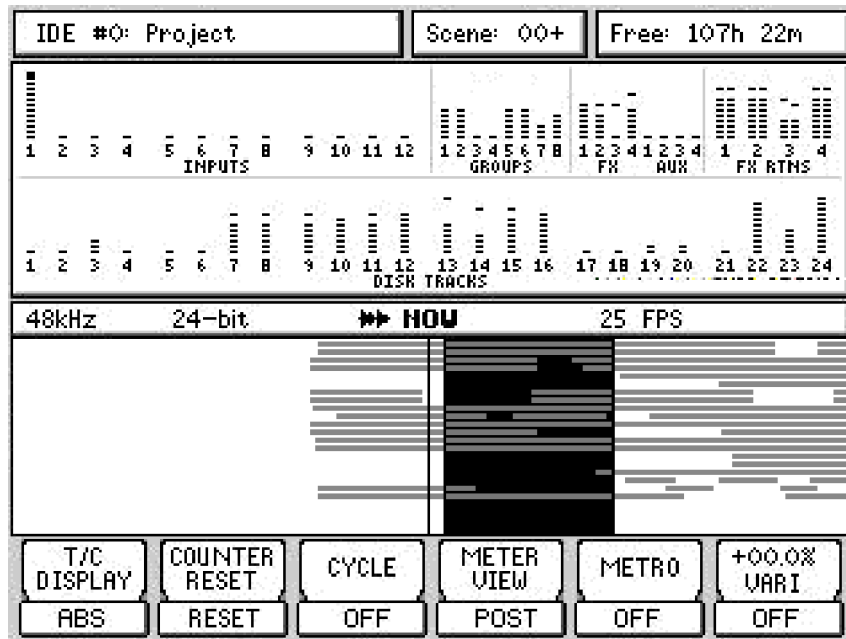

You can see an overview of the project plus level metering of inputs, the eight groups, the FX and AUX sends, FX returns and disk tracks. You may zoom in/out on the Track overview horizontally by pressing SHIFT+ CURSOR </> (you cannot zoom in vertically).

The NOW line is fixed and the cues scroll across the screen from right to left.

The soft keys's functions are as follows:

- T/C DISPLAY      Selects ABS(olute) or REL(ative) time display.
- COUNTER RESET    Resets the REL timecode display to 00:00:00:00 at any point.  
For BARS/BEATS display, this sets the Song Start (Bar 1, Beat 1).
- CYCLE             Switches the CYCLE function on or off.  
When it is switched on, playback is cycling between the IN and OUT markers, with pre-roll and post-roll if enabled.
- NOTE:** Cycle playback is not seamless and there will be a pause as the region cycles. For seamless loop playback, use the LOOP function (SHIFT + IN>OUT).
- METER VIEW        Allows you to select whether metering is pre-eq, pre or post-fader.
- METRO             Switches the metronome on/off. When ON, the metronome is heard through the MONITOR OUT and HEADPHONES output.  
The BPM and time signature of the metronome is governed by the TEMPO MAP (see later -SETUP/TEMPO). The level of the metronome is set in SETUP/PREFS.
- VARI                Switches VARISPEED on or off. You can use Q6 to the key's right to set the varispeed amount. This can be switched on or off and adjusted in real-time as the project is playing.

**NOTE:** VARISPEED can only be applied when the Digital Sync in SETUP is set to INTERNAL.

# GRID (GGraphic Interface Display)

Pressing SHIFT+MAIN shows and expanded track display:

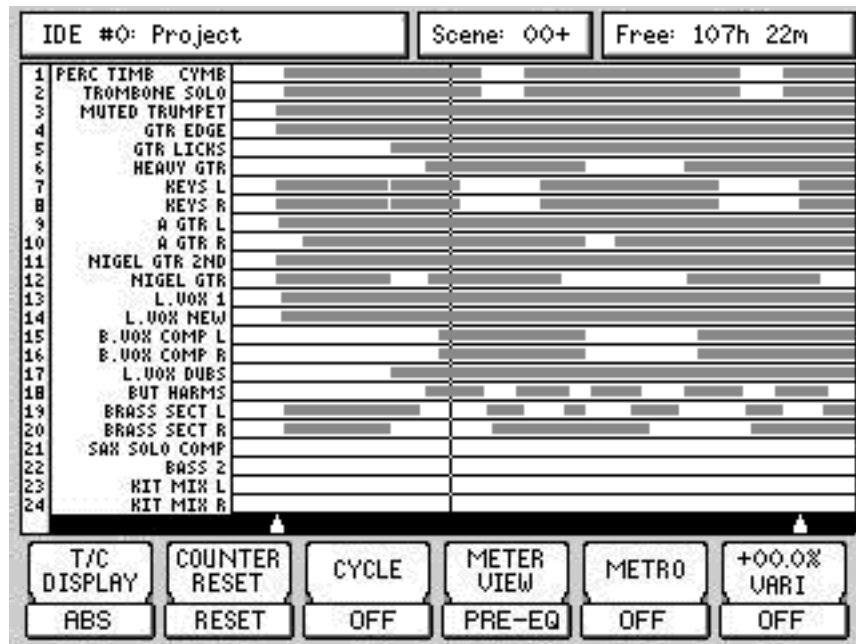

Functionality is the same as the MAIN SCREEN except, of course, you can see the GRID more clearly. This expanded view also allows you to see autolocate points shown as white triangles across the bottom of the display and the track numbers on the left side of the GRID.

Track names can be shown in the GRID view. However, if you don't want them shown, they can be optionally switched on or off in the SETUP /PREFS / MORE page.

When an IN/OUT region is marked, both track displays highlight the region:

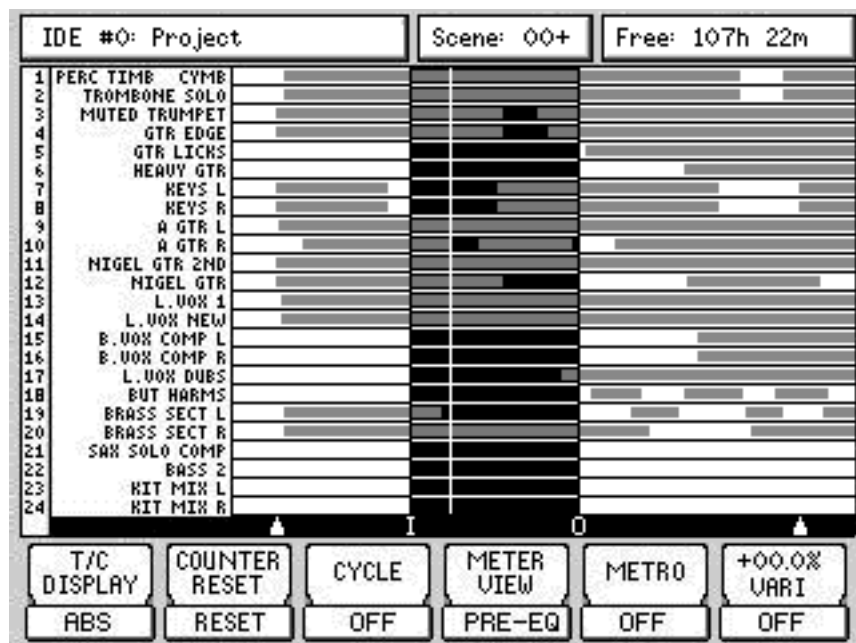

## EDIT MODE

Editing on the DPS24 is simple and non-destructive. You simply mark an IN/OUT region and subject that region to editing. It is possible to edit multiple tracks. When editing, you are not altering the actual audio data - instead, you are simply changing pointers to that audio thus editing is quick as you are not physically copying/removing/moving actual audio data around. Neither are you clogging up your hard disk with duplicate audio data.

In order to edit a track, you should press EDIT and then select the track(s) you want to edit using the RECORD/EDIT SELECT track keys. You will see something like this screen:

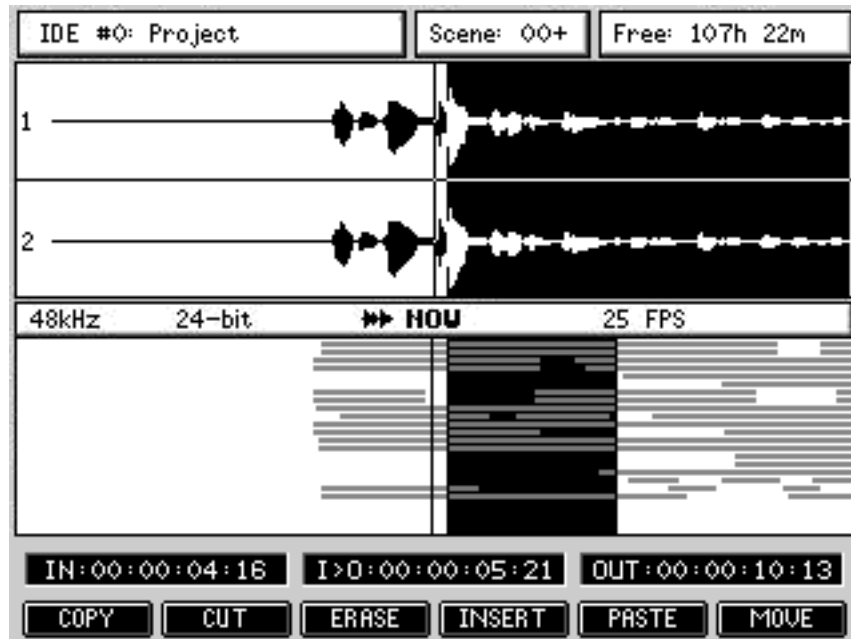

The last selected track's (or tracks') waveform is shown in the upper half of the display in relation to the NOW time and you can also use the overview in the lower portion of the display to reference the edit in context with other tracks.

Also shown are the IN and OUT times and the IN>NOW length. These are shown as timecode or as Bars.Beats.Clocks depending on the selection made by the DISPLAY SELECT key.

Although a maximum of two tracks of waveform display can be shown in the EDIT page, you can actually edit any number of tracks. Other tracks' waveforms may be viewed using the cursor up/down keys to 'scroll' through the tracks - i.e. with tracks 1 and 2 shown, pressing CURSOR DOWN would show tracks 2 and 3, pressing CURSOR DOWN again would show Tracks 3 and 4, etc.. You can also use the Q6 knob to scroll through tracks.

However, you can select the tracks you want to view more directly by pressing SHIFT+RECORD/EDIT SELECT keys. In this way, you can view any combination of two tracks (for example, tracks 7 and 12). It also allows you to edit one track but view another. For example, you may be editing Track 3 but need to use track 14 as a reference - select Track 3 for edit and use SHIFT+EDIT TRACK 3 and 14 to view the two tracks on the LCD.

**NOTE:** There is a further twist to the logic of this function!

*If you select tracks for editing quickly in succession, you will see them both. However, if you wait a while between selecting tracks for edit, only the latest track will be shown.*

*So, for example: you select Tracks 1 and 2 in quick succession - you will see Tracks 1 and 2's waveform in the display. Then you select Track 5 - only track 5's waveform will be shown. Later, you select tracks 7+8 in quick succession - both will be shown... and so on.*



When you press SHIFT and an EDIT SELECT track key, one track is shown:

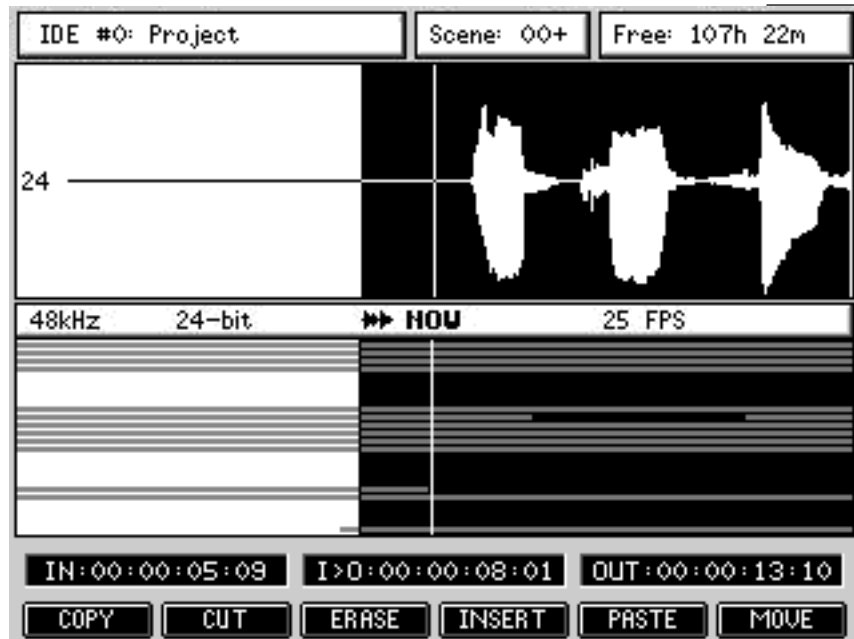

If you press SHIFT and quickly another EDIT SELECT track key, two tracks will be shown:

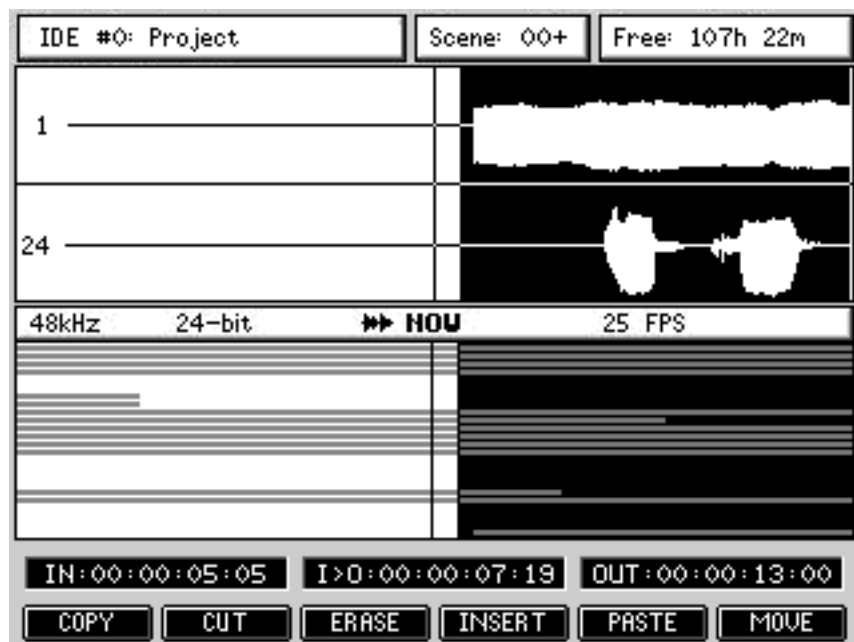

You can also use SHIFT+CURSOR UP/DOWN to increase (or decrease) vertical (i.e. amplitude) resolution for the selected track(s).

When editing, you can use the JOG wheel to fine tune your edit - jog to the point in the waveform display and press IN (or OUT) to re-define the edit region.

Using SHIFT+CURSOR LEFT/RIGHT, you may zoom in/out on the waveform horizontally:

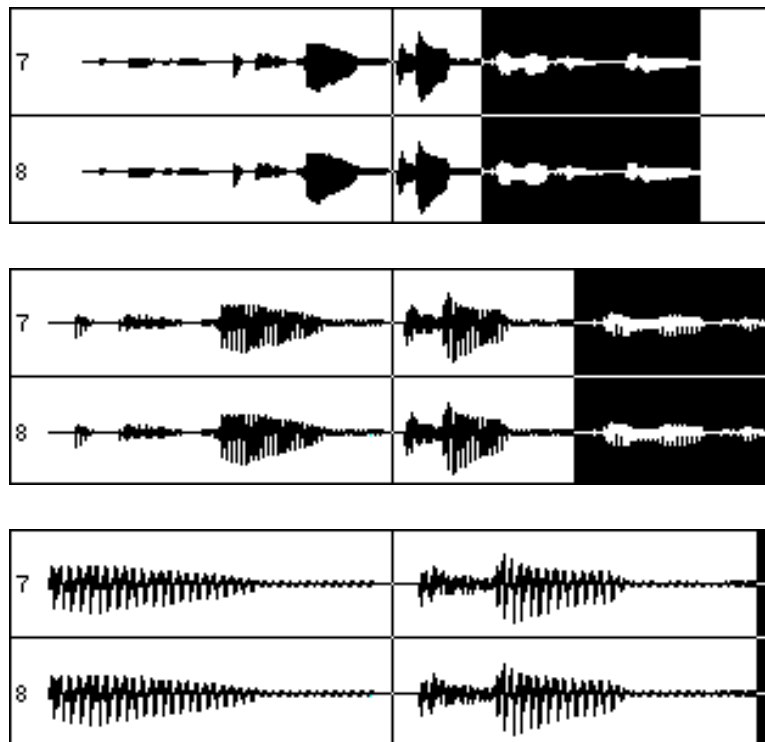

At any resolution, you can use the numerical keypad's +/- keys or the Q5 knob, to nudge the NOW time forwards or backwards by one pixel increments to fine tune your edit points.

At the maximum horizontal zoom, one pixel of the LCD represents one sample. This means that you can set sample accurate edit points.

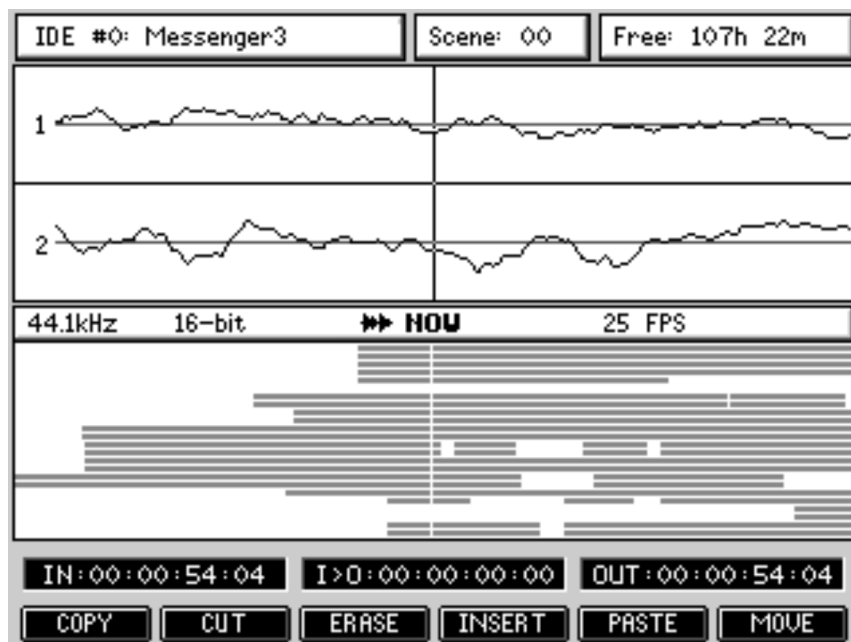

From the main EDIT mode, the F1-F6 softkeys provide access to the individual edit function pages.



All EDIT function pages look more or less like this:

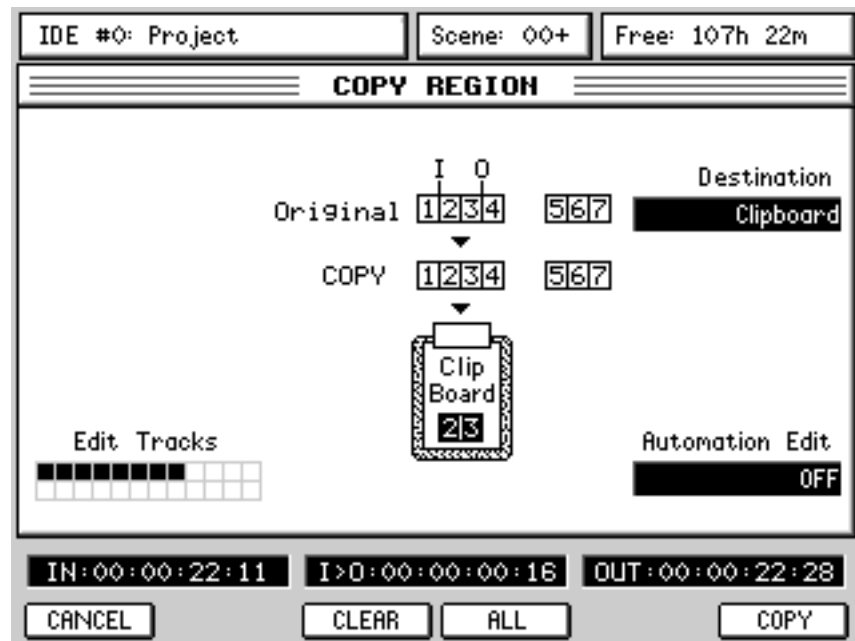

In all EDIT function pages, you can see a graphic representation of the selected EDIT function.

The Edit Tracks graphic shows you which tracks are selected for edit (same as the 24 RECORD/EDIT SELECT keys).

The CLEAR (F3) and ALL (F4) buttons give you a quick way of deselecting or selecting all tracks for edit.

F6 (or the ENTER key) performs the selected edit function and returns to the main EDIT screen. CANCEL (F1) (or the CANCEL key) returns to the main EDIT screen without performing the edit.

Q5 selects the Automation Edit options.

## EDITING AND AUTOMATION

When performing edits that cause audio to move, it is necessary to edit any automation data that exists in that region accordingly. If automation data is left untouched by an audio edit, the mix will be wrong. For example, when removing a piece of audio:

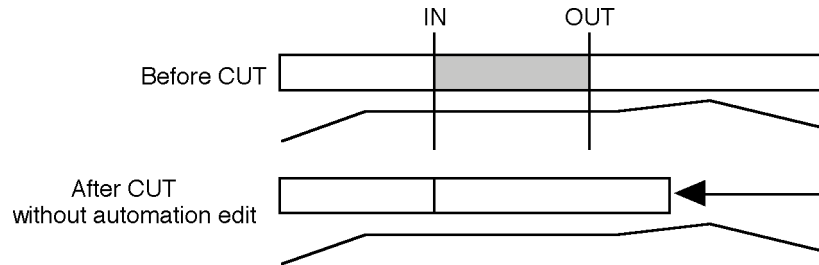

Without including the automation data in the edit, the fade is now in the wrong place.

Editing automation data with the audio edit means that the fade is still in the correct place relative to the audio:

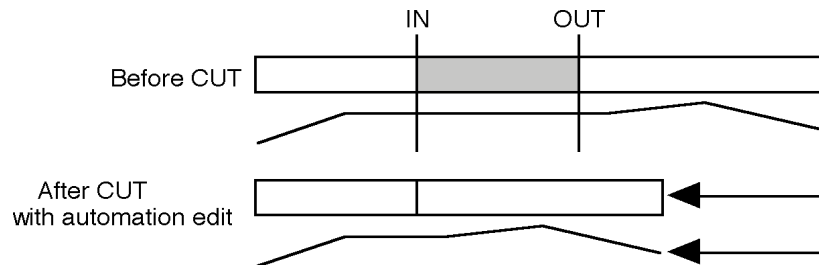

The editing functions on the DPS24 include a Q-LINK control that allows you to decide whether automation data will be affected by the edit or not. This parameter exists on all the audio edit functions allowing you to decide how the automation will be affected when editing.

The options are:

- |          |  |
|----------|--|
| OFF      | Automation data will not be carried with the audio edit.   |
| SELECTED | Automation data on the tracks selected for editing will be carried with the edit.  |
| ALL      | Automation for all channels will be carried with the audio edit. This latter option is only useful if you are doing extensive multi-track editing (for example, editing all 24-tracks where you may also want the mix of external instruments being sequenced through the Input channels to also be carried across with the edit). |

**NOTE:** Care should be taken if you perform an edit with ALL selected and then attempt to paste/insert that edit with SELECTED chosen as the AUTOMATION EDIT. In this case, your automation data at the point of the insert will be potentially disrupted. If you perform an edit with ALL selected, this should only then be used with PASTE/INSERT also set to ALL.

The edit functions are as follows:

## COPY

Pressing COPY [F1] displays this screen:

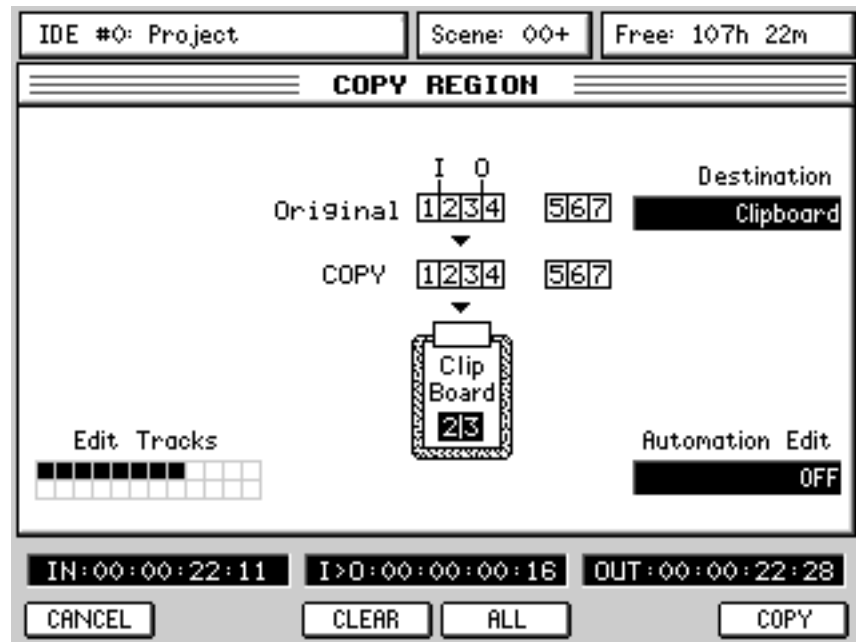

Pressing COPY [F6] or the ENTER key will copy the region to the clipboard from where it may be subsequently pasted and/or inserted elsewhere in the project.

**NOTE:** It is possible to copy edits between projects that are stored on the same drive.

Select the track(s) you want to edit, mark your edit region and press COPY. Now load the project you want to place the edit in, select the destination tracks and locate to the position you want the edit to be placed and use the PASTE or INSERT function (explained later) to place the region in that project.

CUT and ERASE also copy the region to the clipboard so you can place audio regions you remove in other projects as well.

Destination [Q2] allows to select between the regular Copy Region function (Clipboard) and the Export Region function. The Export feature is described later in this manual.

Automation Edit [Q5] allows you to also copy the automation for that region.

**CUT** Pressing CUT[F2] displays this screen:

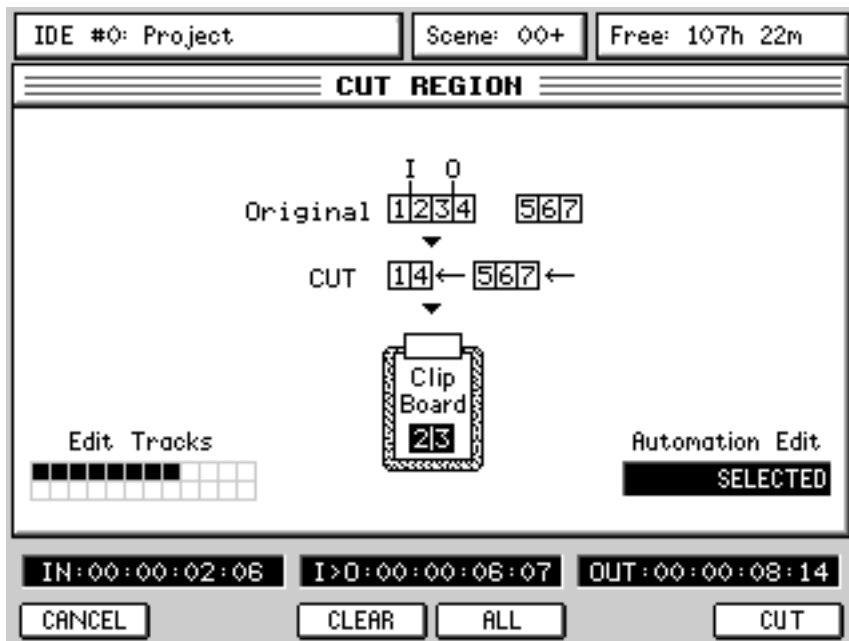

Pressing CUT [F6] or the ENTER key will remove the selected IN/OUT region to the clip-board and close the gap, shifting all subsequent audio backwards.

**ERASE** Pressing ERASE[F3] displays this screen:

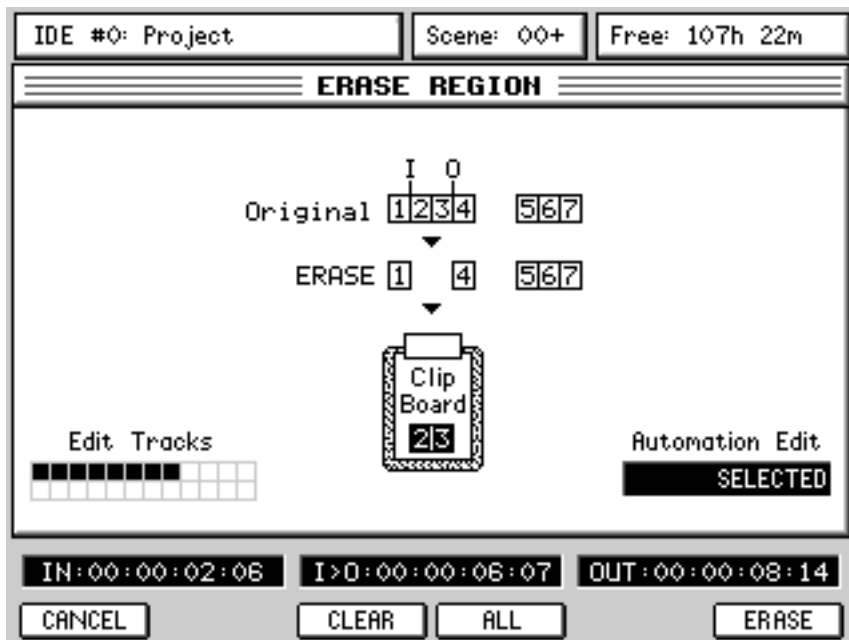

Pressing ERASE [F6] or the ENTER key will remove the selected IN/OUT region to the clip-board but subsequent audio will not slip in time.

**INSERT** Pressing INSERT[F4] displays this screen:

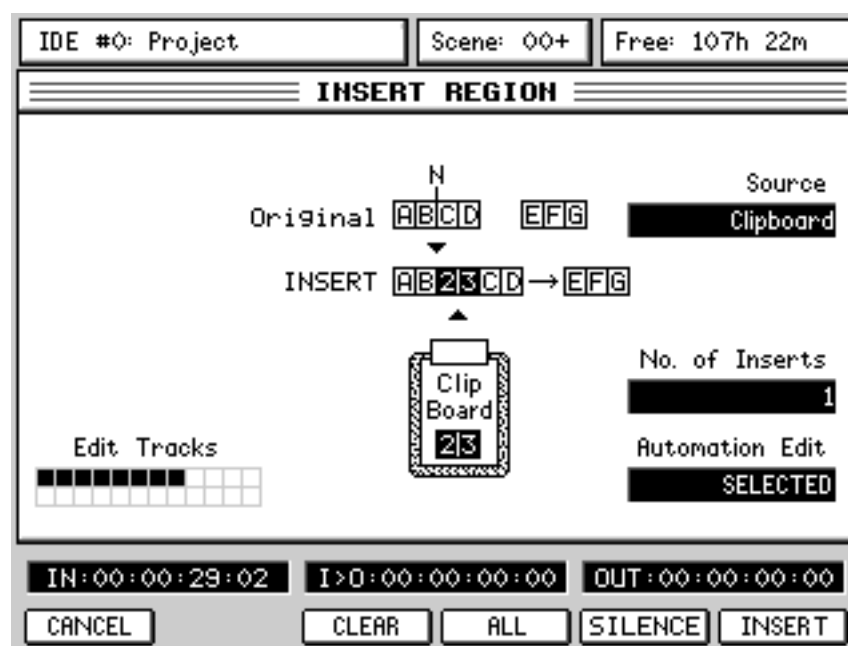

When pressing INSERT [F6] or the ENTER key, the contents of the clipboard are inserted at the NOW time and all subsequent audio is shifted in time.

You can specify the number of times the inserted cue will repeat when inserted using Q5, No. of Inserts. This will insert in the cue n times (up to 99) with each one appended to the end of the previous one.

For example, with 4 repeats specified, you would get this result:

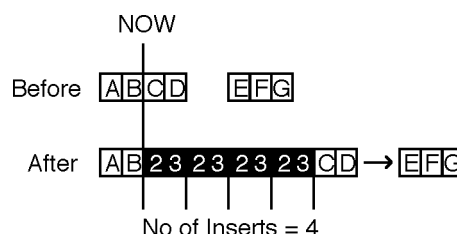

All audio after the point of insertion is shifted accordingly.

Pressing SILENCE [F5] allows you to insert a section of silence that is equal to the IN/OUT region. All audio on the selected track(s) after the IN point will be slipped in time by the IN>OUT length.

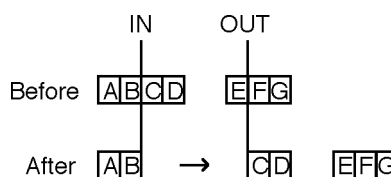

In this function, 'No. of Inserts' is ignored.

**PASTE** Pressing PASTE[F5] displays this screen:

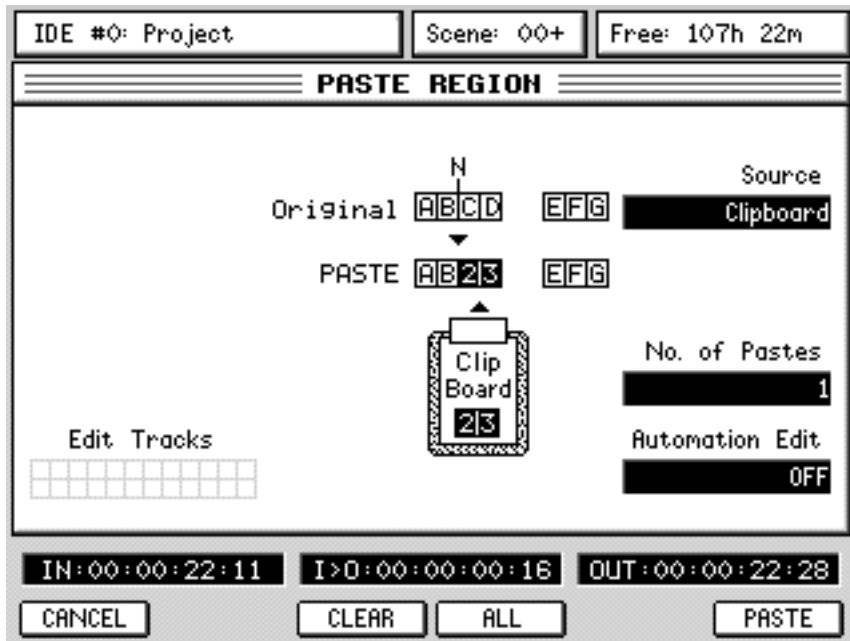

When pressing PASTE [F6] or the ENTER key, the contents of the clipboard is pasted in at the NOW time. Please note, however, that the pasted audio will overwrite anything that exists after the NOW time. If you make a mistake, you should use UNDO.

Using Q5, No. of Pastes, you may specify the number of times the pasted cue will be repeated (up to 99). However, the results are somewhat different than with INSERT:

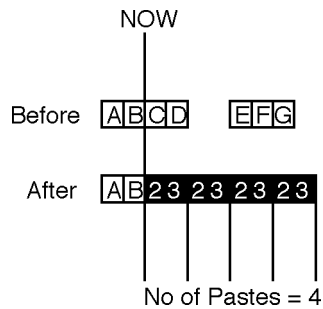

**NOTE:** In this case, it could be that multiple repeats could paste over existing audio on the track. Please consider this when pasting with repeats. If the action tramples over audio you want to keep, don't forget that you can use UNDO!

Source [Q2] allows to select between the regular Paste Region function (Clipboard) and the Import Region function. The Import feature is described later in this manual.



**MOVE**

Pressing MOVE[F6] displays this screen:

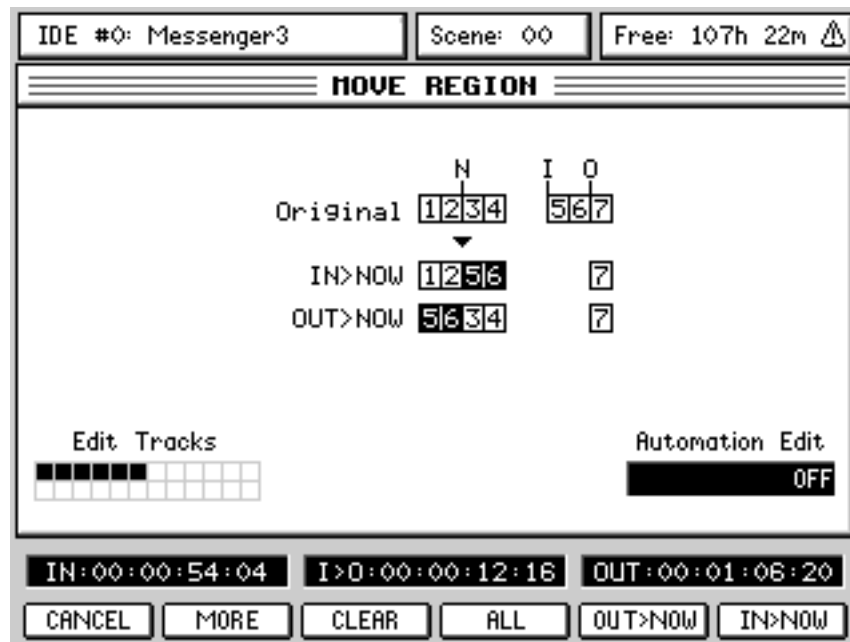

Here, you can slip/move the selected edit region to the NOW time referenced either to its IN point or OUT point.

- IN > NOW [F6] moves the IN/OUT region to start at the NOW time.
- OUT > NOW [F5] moves the IN/OUT region to end at the NOW time.

Pressing MORE [F2] displays this screen:

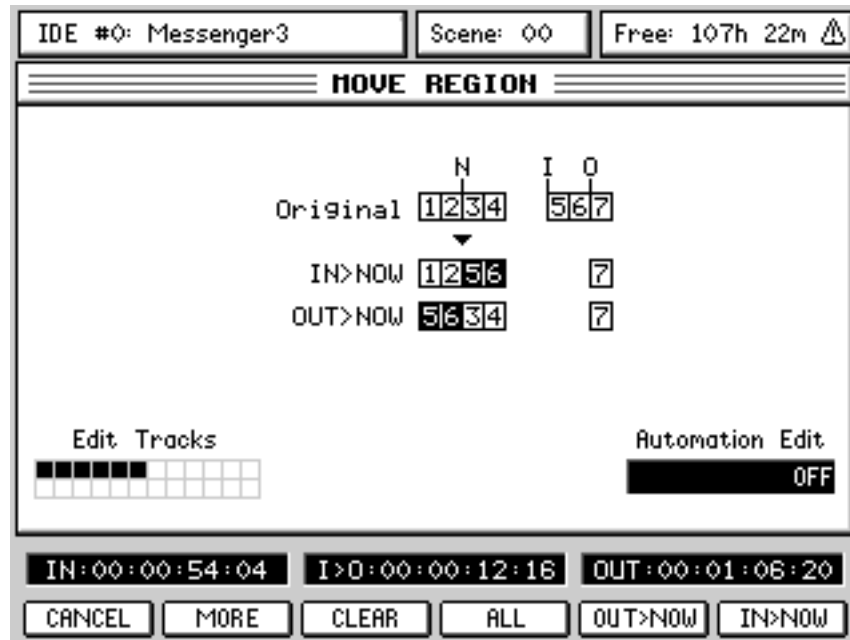

ORIGINAL Pressing F5 will move a recording to the timecode position at which it was originally recorded.

**NOTE 1:** Any subsequent cues within the region on that track are moved such that they stay in the same place with respect to the first cue. This means you can edit or drop-in over a cue and then move the whole lot back to the \*cue's\* original position whilst keeping the edits intact.

**NOTE 2:** Each track is processed separately, so different tracks may end up in different places, the first cue within the region being the significant one.

TO TRACK Although easily achieved using ERASE and PASTE, this function allows you to move audio from one track to another quickly and easily.

Pressing TO TRACK [F6] will pop up this prompt:



The source tracks are those selected for editing using the EDIT SELECT keys before pressing TO TRACK [F6].

The destination tracks are those where you want the source tracks to be moved to. To select the destination tracks, simply press the EDIT SELECT keys until the number of destination tracks corresponds to the source tracks at which point the tracks will be moved. They will remain at exactly the same timecode position.

How is this useful? The same function is possible using ERASE and PASTE but the new MOVE TO TRACKS function achieves the same result with fewer key presses.

## WAV/AIFF IMPORT

The DPS24 allows you to import audio files that have been recorded/edited on other systems. The IMPORT function is available in the EDIT mode in the PASTE and INSERT pages:

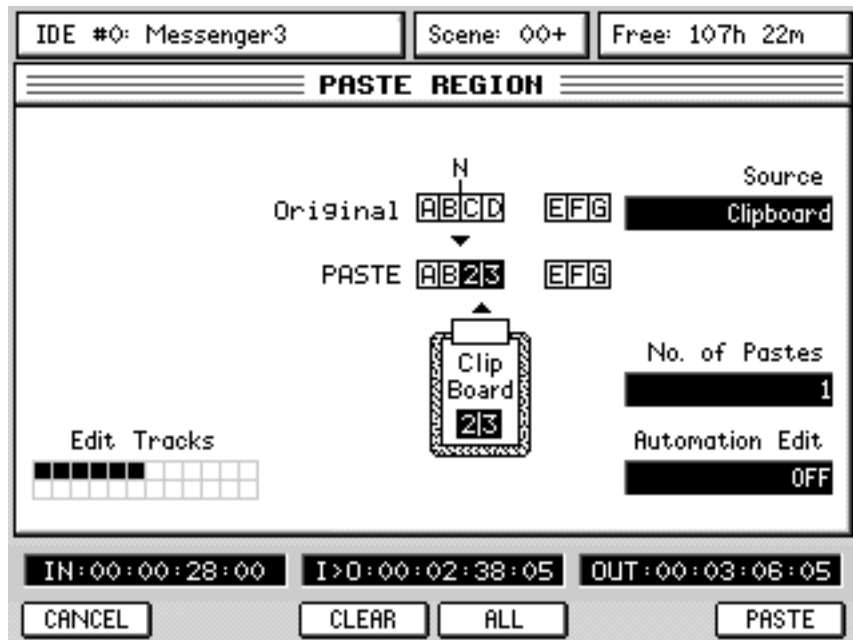

The Source on Q2 allows you to select the source of the PASTE / INSERT. By default, this is set to CLIPBOARD and the paste / insert will be as normal from the DPS24's internal clipboard.

However, it is possible to use Q2 to select any of the installed or externally connected drives:

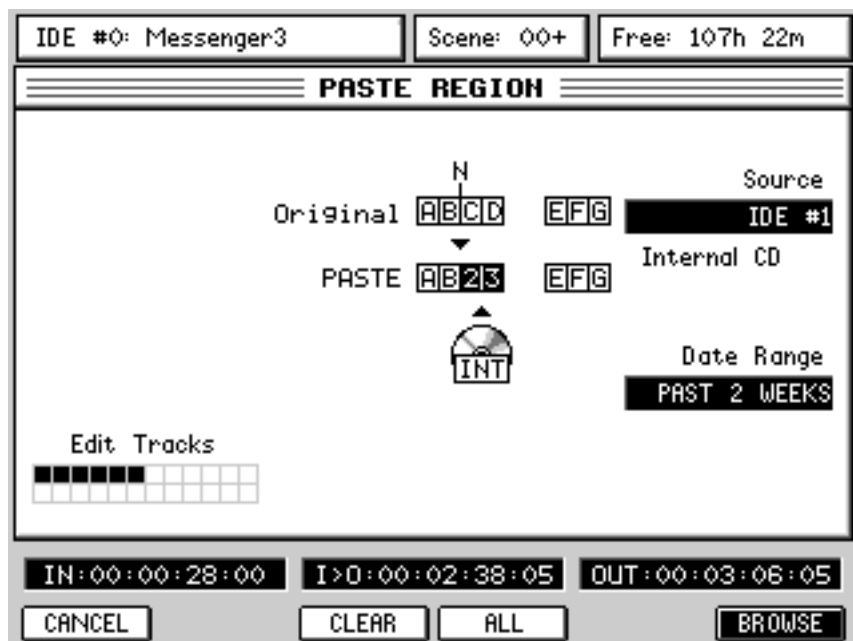

When a drive is selected (in the example shown above, the internal CD on IDE#1 is the selected drive), F6 changes to show BROWSE. This allows you to see the contents of the selected drive.

Audio files can be imported from any connected drive, except the current Project drive.

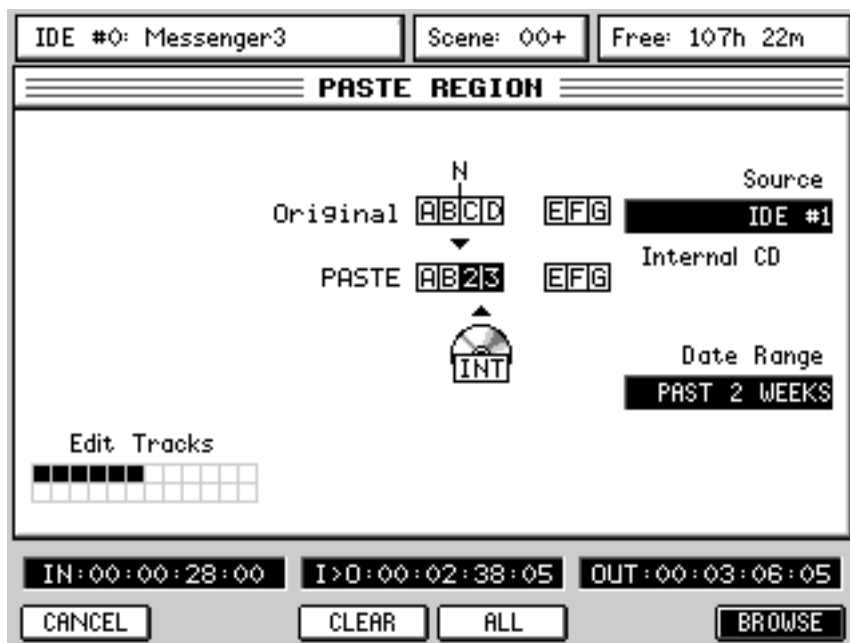

The types of drives available are:

- IDE#0 : Internal HD
- IDE#1 : Internal CD (or Internal HD if using a removable hard drive in place of the CD-R)
- SCSI#0-6 : External HD or External CD, (with the IB-24SCSI option board installed)
- HOST#0-7 : Remote HD (when connected to a computer via USB, using akSysServer)

The drive formats that are recognized are:

- CD-R : ISO9660 CDs      Hard disk : FAT32
- Removable media (such as ZIP disks) : FAT16

The file formats that can be imported are:

- 16 or 24bit      Mono, Stereo or Multi-channel
- WAV, Broadcast WAV (.wav or .bwf extensions) or AIFF files (.aif extension)

**NOTE:** The extension must be present for the DPS24 to recognize the file.

The DATE RANGE parameter [Q4] allows you to select what files you will view when using BROWSE, based on their creation date.

The options are:

- |               |  |
|---------------|--|
| ALL           | You will see all files.                        |
| PAST YEAR     | You will only see files from the past year     |
| PAST 6 MONTHS | You will only see files from the past 6 months |
| PAST 2 MONTHS | You will only see files from the past 2 months |
| PAST MONTH    | You will only see files from the past month    |
| PAST 2 WEEKS  | You will only see files from the past 2 weeks  |
| PAST WEEK     | You will only see files from the past week     |
| TODAY         | You will only see files from the current date  |

Pressing BROWSE [F6] shows a screen that displays the files on the selected drive:

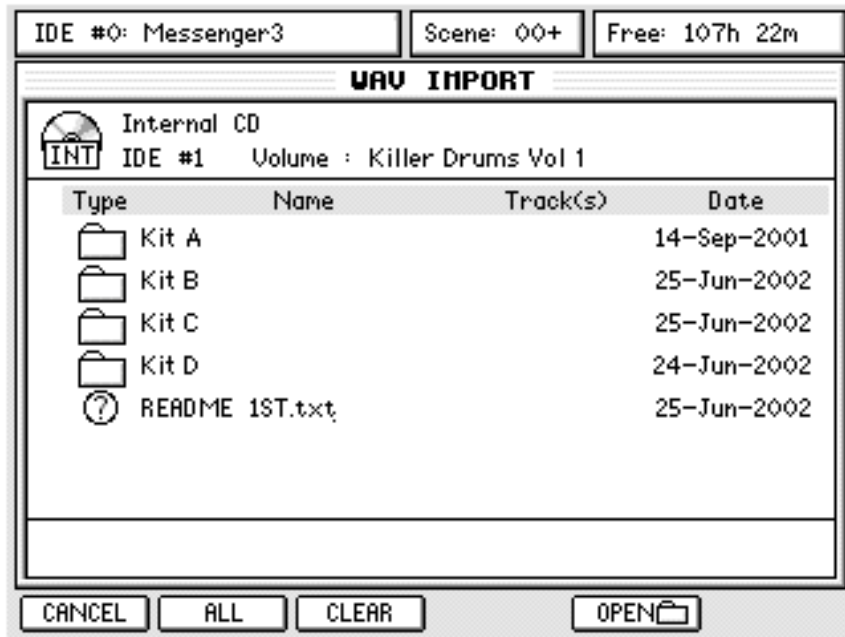

Folders on the disk are shown and these can be opened with the OPEN key on F5:

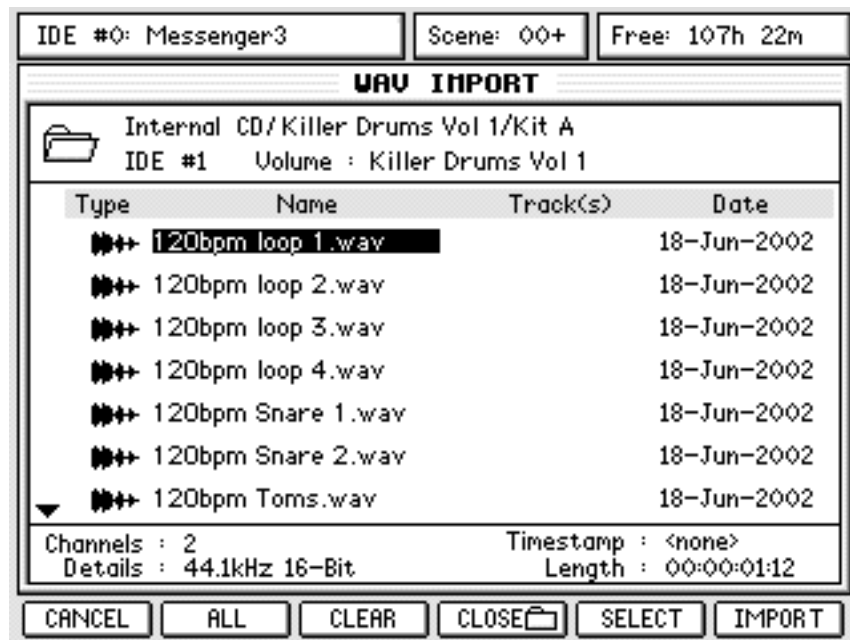

You will see the contents of the selected folder. In the example shown above, you can see the .wav files listed. You can move the cursor up and down through the list to see the various files.

When the cursor is placed over a compatible audio file, the file information is displayed at the bottom of the screen: Number of Channels, Sample Rate, Bit Depth, Length and Timestamp.

Once you have located the file that you wish to import, press SELECT [F5] to select it. The selected file will be 'ticked' for confirmation.

To 'de-select' a file, either press SELECT again or press CLEAR [F3]

Also the destination tracks will be shown alongside the file selected for import:

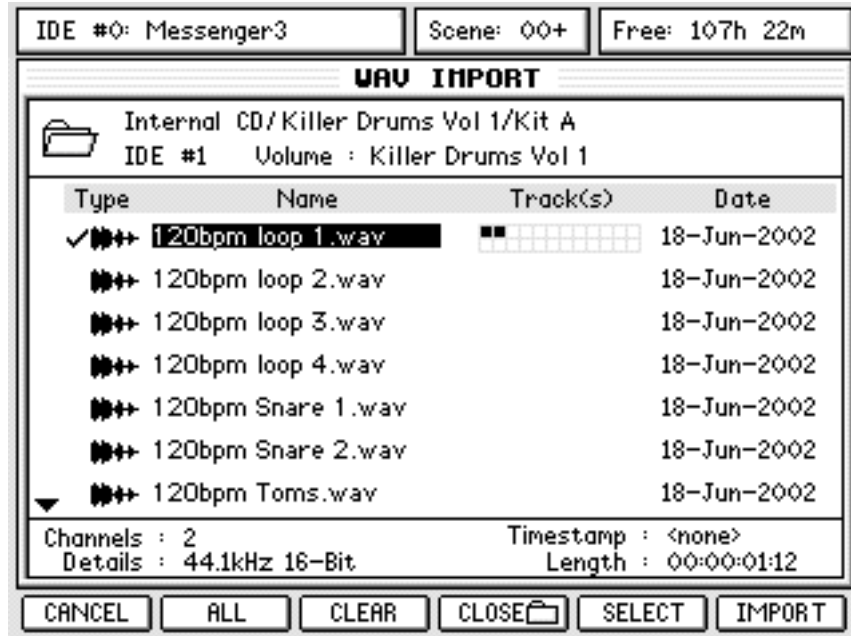

Using the RECORD/EDIT SELECT keys, select the tracks to import the audio file to, so that the number to selected tracks is at least equal to the number of Channels in the audio file. If there are more tracks selected than the number of Channels, the file will be imported to the lowest track numbers.

If there are less tracks enabled for EDIT than the number of Channels to be imported, the following error message will be displayed:

Please select file(s) and destination tracks for import!

All you need to do now is press IMPORT. You will see something like this screen:

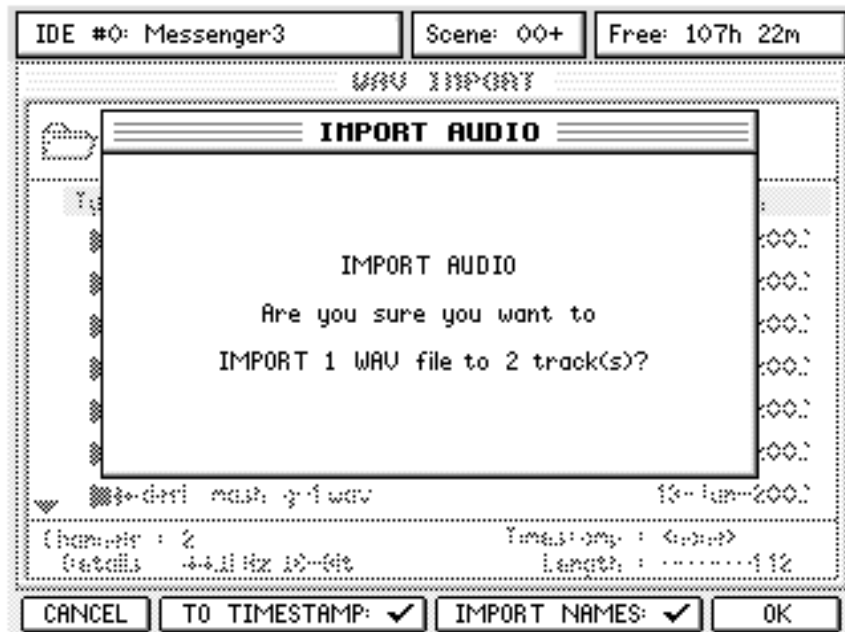

You now have two options you can choose before you proceed.

**TO TIMESTAMP [F2/F3]:** Allows you to have the .wav file automatically placed at its own original timestamp within the DPS24 project. With Broadcast wavs (.wav or .bwf), it is possible to store the timestamp information as part of the file. This is not to be confused with the time of the day it was recorded (i.e. 2.15pm) but the time/position in the project where it was recorded.

So, for example, if you recorded something in a three minute project during the middle eight, it would have a timestamp of (say) 00:01:43. Many (if not most) hard disk recording systems support this feature and so, when importing files from other systems, the DPS24 can use these timestamps so that the recordings you are importing are placed in exactly the same place in the DPS24 project as they were in the other system's project. This feature is ideal for importing project from other systems, especially when importing multiple .wavs from a multi-track project. We will look at this later when we discuss IMPORTING MULTITRACK WAV FILES.

**IMPORT NAMES [F4/F5]:** With this checked (i.e. 'ticked'), the file name will be imported and used as the name for the track(s) the file is being imported onto.

For example, in the example shown above, tracks 1 and 2 will automatically be named "120bpm loop 1". this can be very useful when importing material that will form an entire track but please note that if you are importing several different files onto the same track (for example, importing sound effects one after each other on the same track), the track name will be that of the most recently imported file.

Once you have made your selection, press OK.

When WAV/AIFF files are imported into a project, they are automatically re-sampled to the project's sampling rate thus ensuring that they will play at the correct speed within the context of that project.

So, for example, if a 48kHz WAV is imported into a 44.1kHz project, the imported file will be re-sampled down to 44.1kHz.

If you try to import a file that is at a different sample rate than the current project, you are prompted the following message and you can respond accordingly:

```

One or more files are not
at the same sample rate as
project, these files will be
sample rate converted.
Continue?

```

Once the Import process starts, you will see a progress display as the file is imported to the selected tracks.

At the end of the process, you will see a confirmation dialog - press OK [F6]

The import is done!

**NOTE:** When importing a single file, you can (if you want) press IMPORT [F6] directly without selecting it with SELECT [F5] first, if tracks are already selected for EDIT.

## IMPORTING MULTIPLE WAV FILES TO MULTIPLE TRACKS

Importing multiple .wav files to multiple tracks is pretty much the same as importing single files. The DPS24 allows you to import up to 24 tracks in one pass.

To recap the import process, locate to the point where you want to import the files, press EDIT and select the required number of tracks for edit. Go to PASTE or INSERT and select the appropriate source drive that contains the files you want import. Press BROWSE and navigate the disk to find the files you want to import:

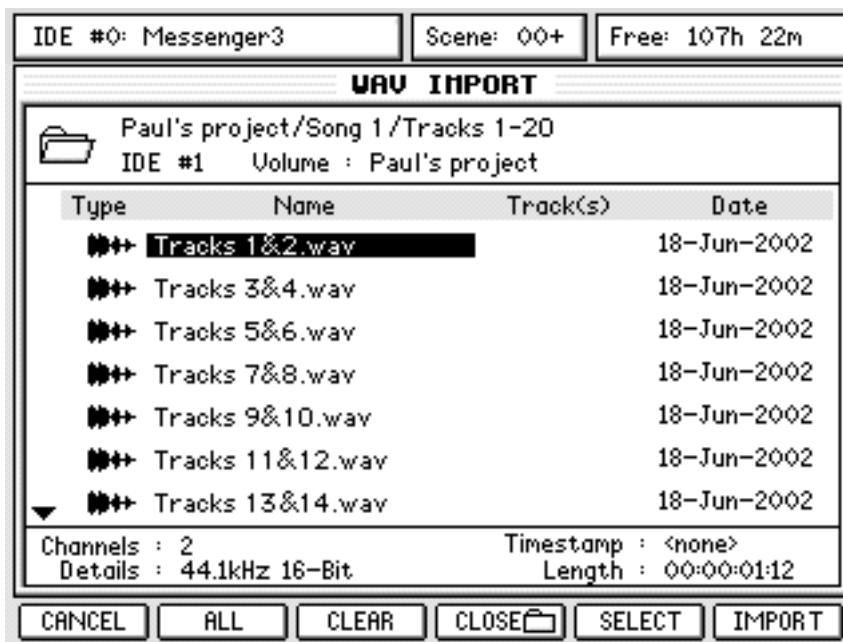

To import multiple files, select them using the CURSOR keys and use the SELECT key to 'mark' them:

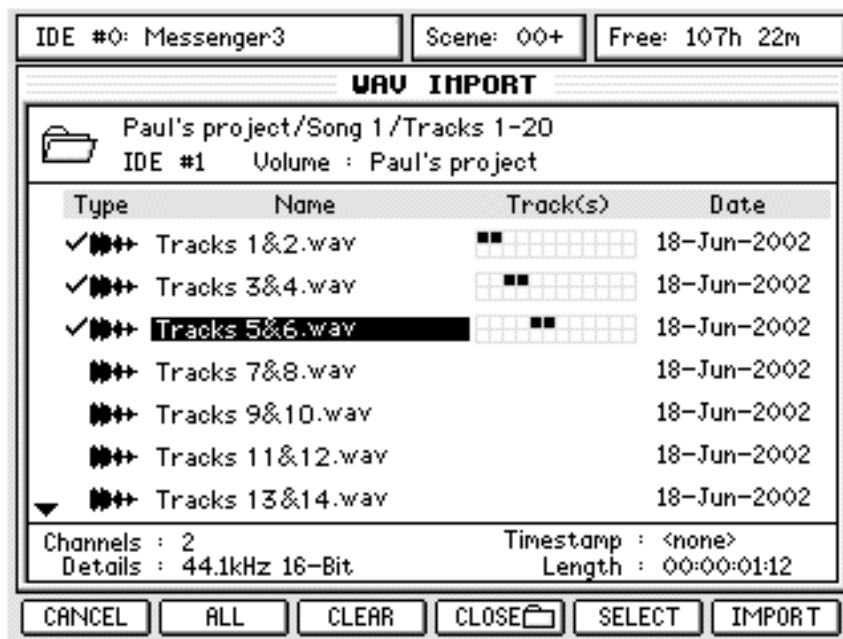



Now, as you select each file, you will see an indication of the tracks that each file will end up on shown to the right of the filename:

Type	Name	Track(s)
✓	Tracks 1&2.wav	<input checked="" type="checkbox"/> <input checked="" type="checkbox"/> <input type="checkbox"/> <input type="checkbox"/> <input type="checkbox"/> <input type="checkbox"/> <input type="checkbox"/> <input type="checkbox"/> <input type="checkbox"/> <input type="checkbox"/> <input type="checkbox"/> <input type="checkbox"/> <input type="checkbox"/> <input type="checkbox"/> <input type="checkbox"/> <input type="checkbox"/> <input type="checkbox"/> <input type="checkbox"/> <input type="checkbox"/> <input type="checkbox"/> <input type="checkbox"/>
✓	Tracks 3&4.wav	<input type="checkbox"/> <input type="checkbox"/> <input checked="" type="checkbox"/> <input checked="" type="checkbox"/> <input type="checkbox"/> <input type="checkbox"/> <input type="checkbox"/> <input type="checkbox"/> <input type="checkbox"/> <input type="checkbox"/> <input type="checkbox"/> <input type="checkbox"/> <input type="checkbox"/> <input type="checkbox"/> <input type="checkbox"/> <input type="checkbox"/> <input type="checkbox"/> <input type="checkbox"/> <input type="checkbox"/> <input type="checkbox"/> <input type="checkbox"/>
✓	Tracks 5&6.wav	<input type="checkbox"/> <input type="checkbox"/> <input type="checkbox"/> <input type="checkbox"/> <input checked="" type="checkbox"/> <input checked="" type="checkbox"/> <input type="checkbox"/> <input type="checkbox"/> <input type="checkbox"/> <input type="checkbox"/> <input type="checkbox"/> <input type="checkbox"/> <input type="checkbox"/> <input type="checkbox"/> <input type="checkbox"/> <input type="checkbox"/> <input type="checkbox"/> <input type="checkbox"/> <input type="checkbox"/> <input type="checkbox"/> <input type="checkbox"/>

In the above example (which shows a typical application for multiple file insertion - importing projects made on other systems), the track are shown in descending order and so it would make sense to put the various files on the same tracks as the DPS24.

However, you can set the tracks the file(s) will be allocated to simply by selecting them in order. So, for example, if for some reason you wanted to allocate the above as follows:

FILENAME	DPS24 TRACKS
Tracks 1&2.wav	Tracks 5 and 6
Tracks 3&4.wav	Tracks 1 and 2
Tracks 5&6.wav	Tracks 3 and 4

You would press the SELECT key in the following order:

- 1 Tracks 3&4.wav
- 2 Tracks 5&6.wav
- 3 Tracks 1&2.wav

And you would see this on the screen with the files allocated to the tracks accordingly:

Type	Name	Track(s)
✓	Tracks 1&2.wav	<input type="checkbox"/> <input type="checkbox"/> <input checked="" type="checkbox"/> <input checked="" type="checkbox"/> <input type="checkbox"/> <input type="checkbox"/> <input type="checkbox"/> <input type="checkbox"/> <input type="checkbox"/> <input type="checkbox"/> <input type="checkbox"/> <input type="checkbox"/> <input type="checkbox"/> <input type="checkbox"/> <input type="checkbox"/> <input type="checkbox"/> <input type="checkbox"/> <input type="checkbox"/> <input type="checkbox"/> <input type="checkbox"/> <input type="checkbox"/>
✓	Tracks 3&4.wav	<input checked="" type="checkbox"/> <input checked="" type="checkbox"/> <input type="checkbox"/> <input type="checkbox"/> <input type="checkbox"/> <input type="checkbox"/> <input type="checkbox"/> <input type="checkbox"/> <input type="checkbox"/> <input type="checkbox"/> <input type="checkbox"/> <input type="checkbox"/> <input type="checkbox"/> <input type="checkbox"/> <input type="checkbox"/> <input type="checkbox"/> <input type="checkbox"/> <input type="checkbox"/> <input type="checkbox"/> <input type="checkbox"/> <input type="checkbox"/>
✓	Tracks 5&6.wav	<input type="checkbox"/> <input type="checkbox"/> <input checked="" type="checkbox"/> <input checked="" type="checkbox"/> <input type="checkbox"/> <input type="checkbox"/> <input type="checkbox"/> <input type="checkbox"/> <input type="checkbox"/> <input type="checkbox"/> <input type="checkbox"/> <input type="checkbox"/> <input type="checkbox"/> <input type="checkbox"/> <input type="checkbox"/> <input type="checkbox"/> <input type="checkbox"/> <input type="checkbox"/> <input type="checkbox"/> <input type="checkbox"/> <input type="checkbox"/>

When you're ready and you have selected all the files you want to import, simply press IMPORT on F6.

As with importing a single file, you will receive a prompt asking you to confirm. You will also have the option to select whether the files' timestamps (if any) are used and whether you want to use the filenames as track names:



Only you can decide! However, if you are importing a project from another system, it is quite likely that all the files will be timestamped and so, to retain their relative synchronisation when imported into the DPS24, it would be best to enable TO TIMESTAMP.

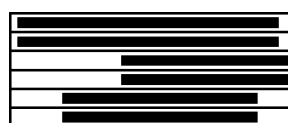

Original project

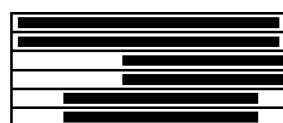

After IMPORT with timestamps

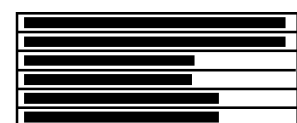

After IMPORT without timestamps

Also, if you are importing projects from another system, it's quite likely that the tracks will have been named so it might be wise to use IMPORT NAMES as well. Whatever you choose, to import the files, press OK. You will see a progress display as the files are imported and at the end of the process, you will see a confirmation dialogue - press OK [F6].

Importing multiple files in this way is ideal for working on projects that have been created on other systems. Although the DPS24 cannot read their Q-Lists directly, being able to read each file's timestamp on the DPS24 allows you to effectively re-create the Q-List from the project on that system.

However, please note one thing...

It's quite possible that the original project created on the other system has several cues at different times on one track:

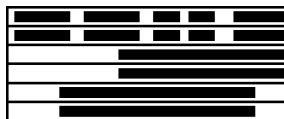

Of course, all these small cues have unique timestamps but, because it is not possible to assign more than one recording to any given DPS24 track, the individual files will need to be spread across several tracks.

However, having said that, most systems should be able 'render' these individual recordings as one long take that can be placed on one track (or a stereo pair) of the DPS24. I.e.



Original project  
after rendering

Many systems will render individual recordings by default.

## WAV/AIFF FILES EXPORT

The DPS24 also allows you to export audio recordings to an IDE or SCSI CD-R (ISO 9660) or hard disk (FAT32/16), or to a computer via USB. You can export up to 24 tracks in one pass.

The export function is available as part of the COPY function in the EDIT pages.

The process is almost identical to copying audio within a project: select the track(s) you want to export, mark an IN/OUT region, and copy it. The difference is that you are copying it to a CD/HD instead of the internal clipboard.

To access the EXPORT function, press EDIT, press COPY [F1]. You will see this screen:

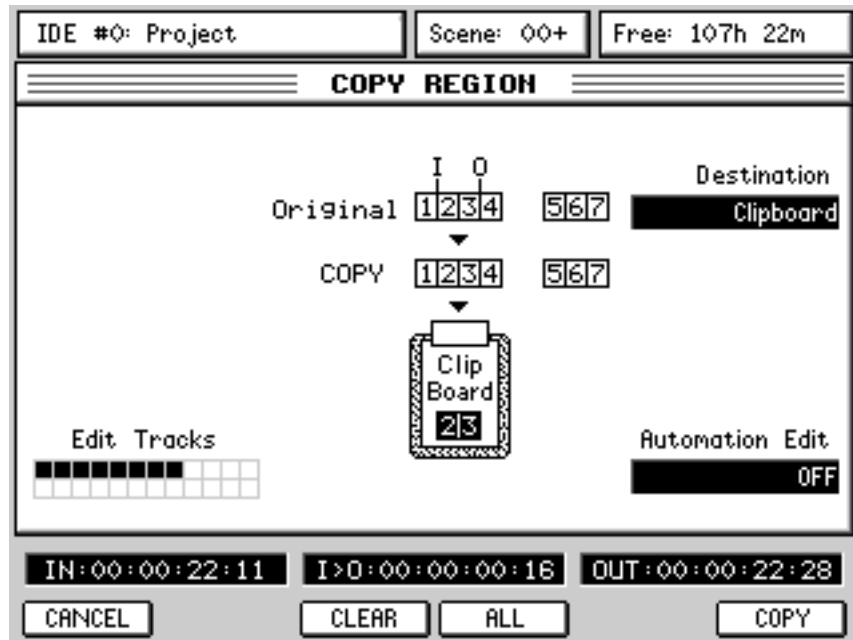

Using Q2, select the Destination drive you want to export the tracks to.

The available drive selections are the same as for Import (IDE, SCSI or HOST).

The display changes to the EXPORT REGION screen, according to the Destination selection:

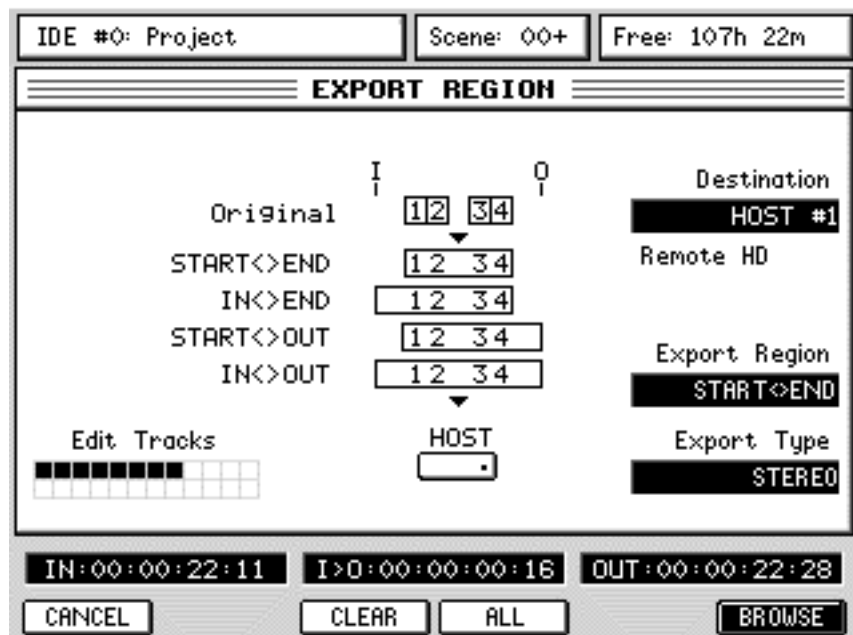

Q4 allows you to select the Export Region options for the export.

The graphic on the EXPORT REGION page should give a clue to the end result.

These options are:

- START <> END Only the actual audio contained from the start of the first cue to the end of the last cue within the IN/OUT region will be exported.
- IN <> END The audio between the marked IN point and the end of the actual audio within the IN/OUT region will be exported.
- START <> OUT The audio between the actual start of the audio within the IN/OUT region and the marked OUT point will be exported.
- IN <> OUT The audio between the marked IN / OUT point will be exported.

When START<>END or START<>OUT is selected, each exported file will start only where the actual audio begins, with the start position of the audio in the project stored as a sample accurate timestamp attached to the WAV file (Broadcast WAV).

When IN<>END or IN<>OUT is selected, if the actual audio starts after the IN point, the exported file will include "recorded" silence from the IN point to the start of the audio. Therefore, all the files exported in the same pass will start exactly at the same point, allowing them to line up when imported in a system that doesn't support Broadcast WAV timestamps.

One thing to note, is that all audio within any of the selected options will be 'rendered'. In other words, if (for example) a particular track has a load of small, individual cues in the original DPS24 project, when exported, that track will be one continuous .wav file.

For example:



Original track



The exported version

Q5 allows you to select the Export Type. The options are:

- MONO Each of the selected tracks will be exported as individual, separate mono timestamped files.
- STEREO Disk channels that are paired as 'stereo' will have their recordings exported as stereo timestamped files. Those channels that aren't 'paired' will still be exported as individual timestamped mono files.
- MULTI-CHANNEL This option will cause the selected tracks to be exported as a single multi-channel .wav file. This is only appropriate for exporting entire projects to other multi-track systems that support Multi-Channel WAV files (such as the DPS16). However, please note... track-order is preserved. For example, if DPS24 edit tracks 1,2,4,5,6,11,12 are selected, these will map to channels 1,2,3,4,5,6,7 of the multi-channel .wav file).

To actually export the audio, press BROWSE. You might see "Please wait" for a few seconds.

If the selected drive is a hard drive (Internal, External or Remote HD), you will see this screen:

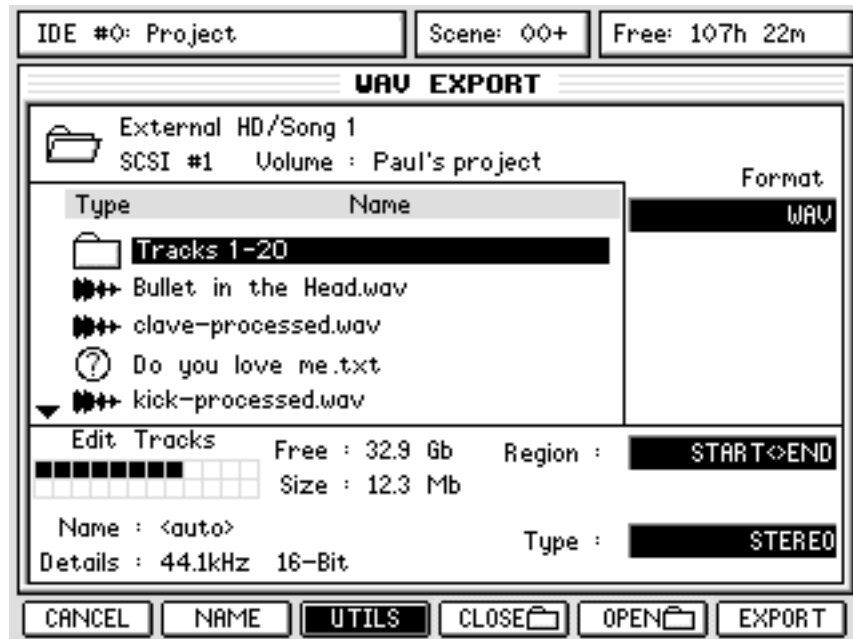

If the selected drive is a CD-R/RW drive, you will see this slightly different screen :

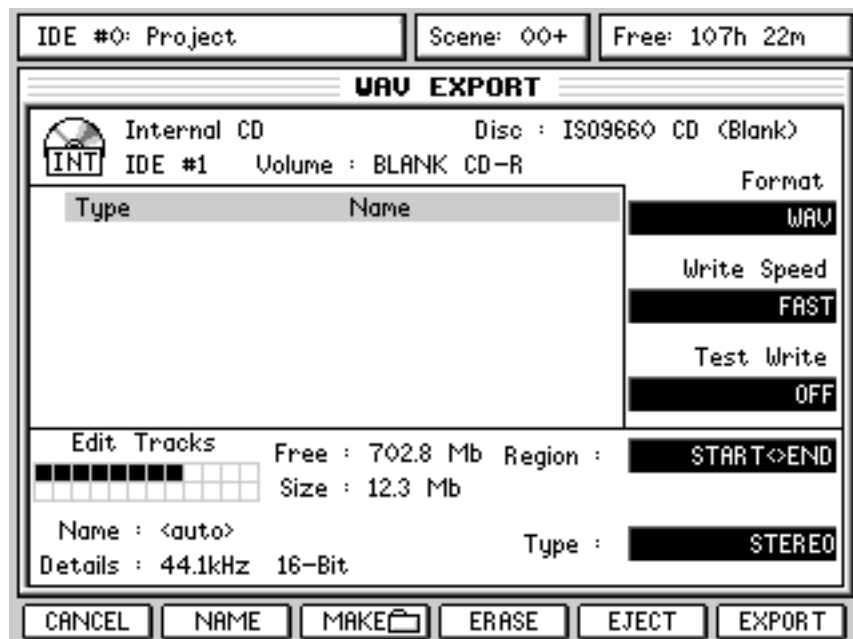

The main export features are identical but CD and HD drives have some specific functions.

In both cases, Q2 allows you to select the Export file Format, as WAV or AIFF.

AIFF is only intended for use with older Apple Macintosh based systems. However, the AIFF file format does not include timestamps. Most current Macintosh based systems now support WAV or Broadcast WAV files. When WAV is selected, the DPS24 exports Broadcast WAV files.

Q5 allows you to select the Export Region options.

Q6 allows you to select the Export Type options.

Those options are the same as in the EXPORT REGION screen and are duplicated here for convenience.

Also shown in the lower part of the display are:

Edit Tracks graphic : shows which tracks are going to be exported

Free : shows the available space on the Destination disk

Size : shows a calculation of the total export size

The export size is recalculated in real-time as the region selection (IN/OUT points, Edit Tracks), Export Region and Type parameters are changed. This way, you always know whether the current selection is going to fit on the Destination disk or not.

Details: shows the Sample Rate and Bit Depth settings of the current Project.

**NOTE:** When exporting, please note that the sample rate/bit depth of exported files is always defined by the current Project settings.

Name: shows the export name (defaults to <auto>)

Export files can be either explicitly named or auto-named.

The NAME key [F2] can be used to enter a specific name. If left blank, it returns to auto-naming.

For named MONO or STEREO exports, the resultant filename has the track number appended. Since MULTI-CHANNEL export will always generate a single file only, nothing is appended to the name.

For auto-named MONO or STEREO exports, the resultant filename is the Channel Name of the track (STEREO exports use the left channel and remove 'L', if present, from the end of the Channel Name).

For auto-named MULTI-CHANNEL exports, the resultant filename is simply the Project name.

*Examples:*

1. Named export 'Test Export' of tracks 1, 2, 3, 7, 11 (with tracks 1 + 2 paired):

MONO	STEREO
Test Export 01.wav	Test Export 01.wav (stereo file)
Test Export 02.wav	Test Export 03.wav
Test Export 03.wav	Test Export 07.wav
Test Export 07.wav	Test Export 11.wav
Test Export 11.wav	

MULTI-CHANNEL

Test Export.wav (5-channel file)

2. Auto-named export of tracks 1, 2, 3, 7, 11 (with tracks 1 + 2 paired):

MONO	STEREO
Guitar 1 L.wav	Guitar 1.wav (stereo file)
Guitar 1 R.wav	Synth FX.wav
Synth FX.wav	Lead Guitar.wav
Lead Guitar.wav	Vocal.wav
Vocal.wav	

MULTI-CHANNEL

Really Cool Project.wav (5-channel file)

If a file already exists on the CD/harddisk with the same name as a file to be exported, a dialog will pop-up allowing the user to auto-rename the file. Auto-renaming consists of appending an incremental number onto the filename (e.g. 'export.wav' -> 'export 2.wav' -> 'export 3.wav').

For harddisks it is possible to overwrite the existing file by selecting NO [F5] at the auto-rename prompt. It is NOT possible to overwrite files on a CD, instead, if NO is selected, the exported file will have the same name as the existing file and will be inaccessible on most systems.

If there are already files on the Destination disk, you will see that data on the display.

If the selected drive is a HD drive, you will be able to browse the files and folders on that disk, Open and Close folders using F4 and F5, create and rename folders and sub-folders, and even rename or delete individual files via the UTILS [F3] menu.

If the selected drive is a CD drive, you will be able to EJECT [F5] the disc or ERASE [F4] the disc if it is a CD-RW media.

If the selected drive is a CD drive, you can also see the type and status of the Disc at the top right of the screen. The various types are: No Disc, Audio CD, Data CD, ISO9660 CD and the various states are (Blank), (Open) or (Closed).

The DPS24 can only export audio files to ISO9660 CDs that are (Blank) or (Open).

With an ISO9660 CD, you will only see the Root directory of the disk, but you will be able to add a Folder in the Root directory using MAKE [F3]. However, only a single level of folders is supported for CD export.

If the selected drive is a CD drive, you will also be able to select SLOW or FAST Write Speed [Q3] and to switch the Test Write mode ON/OFF [Q4].

When ready, just go ahead and export the selected tracks/region by pressing EXPORT [F6]. The following EXPORT AUDIO prompt will be displayed for confirmation, for instance:

```
Are you sure you want to
EXPORT 5 tracks to: 1 stereo file
and 3 mono files?
```

If you press OK [F1], the files will simply be written to the selected folder of the disk as individual mono, stereo or multi-channel files.

The display will keep you informed of the progress of the Export process until Export is Completed.

# DSP MODE

Pressing SHIFT+EDIT gives access to the off-line DSP functions:

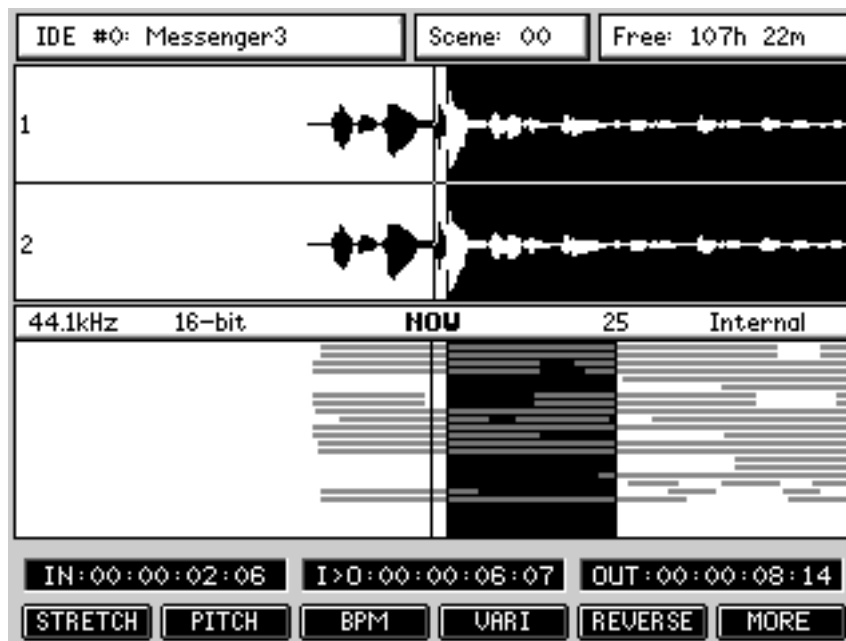

As you can see, the screen layout is virtually identical to the main real-time EDIT screen.

Operation is also the same....

Jog over the point where you want the off-line edit to start and mark an IN point as appropriate. Do the same to mark the OUT point.

Once you are happy with the edit region you have created, you can select the DSP function you wish to apply to it. This will display a window where you can set parameters appropriate to the selected DSP function using the Q-Link controls.

Unlike EDIT functions that only change pointers to the existing audio, off-line DSP functions generate new 'processed' audio files on the disk.

As for EDIT, you can select as many tracks as you need to process.

However, please note that processing time increases proportionally as each track (or pair of stereo tracks) is processed. For example, if processing a stereo track of X length takes Y seconds, processing two stereo tracks of the same length will take twice as long.

**NOTE:** Time stretching/Pitch shifting/BPM matching/Varispeed process the tracks in sets of either mono or stereo tracks, depending on whether the mixer channel is paired or not.

If the mixer channels for selected tracks are paired, the stereo DSP process will remain phase-coherent.

From the main DSP mode, the F1-F5 softkeys provide access to individual DSP function pages. F6 [MORE] allows access to additional DSP functions.

Then, F6 [BACK] returns to the previous DSP menu.





**TIMESTRETCH** This allows you to expand/compress the length of the edit region without changing its pitch.

Pressing STRETCH [F1] displays this screen:

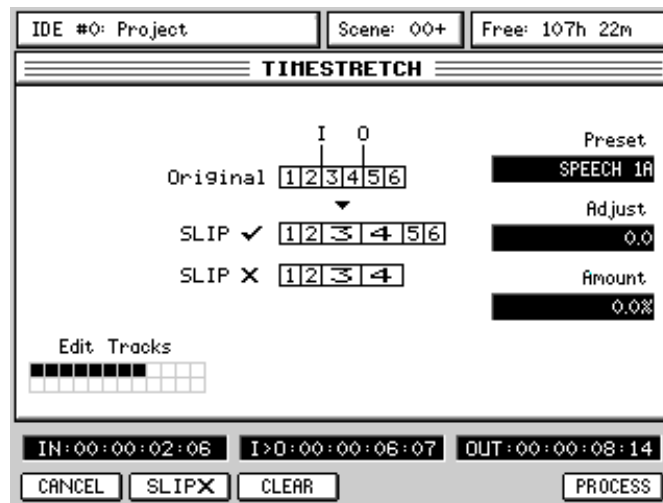

Using Q2, you can select the timestretch preset. All the stretch-related DSP processes have a series of presets optimised for certain types of material. These are:

- SPEECH 1 This works well on female speech.
- SPEECH 2 This works well on male speech.
- SPEECH 3 This is more appropriate for deeper male speech.
- VOCAL This works well with solo and ensemble singing voices in isolation and, in music studio applications would be applicable for processing backing vocals and the like.
- DANCE 1 This works well with rhythmic material with little bass content or bass content that is short.
- DANCE 2 This works well with rhythmic material. HF and MF is handled well and short as are sharp bass sounds.
- DANCE 3 This is also suitable for rhythmic material but will handle longer bass components better.
- PERC 1 This works on very rhythmic material, especially solo drums, etc., but can upset bass content.
- PERC 2 This also works well on percussive material but can handle bass content better.
- HI NRG This works well processing material that is percussive, staccato and rhythmic with a wide frequency range (although sustained bass content may 'wobble').
- BALLAD This works well on material that has long, sustained LF content. Musically, it is effective for processing slow ballads and handles long bass notes quite well but you may occasionally experience slight 'flamming' (i.e. double triggering) with some percussive sounds.

- ROCK 1,2,3 Suitable for processing a wide range of musical styles that have a broad band of bass and high frequency content and rhythmic elements.
- SWING This works well on material with a wide frequency range that is not too percussive.
- ALLEGRO 1 This works well on orchestral music with lively dynamic strings and HF content.
- ALLEGRO 2 This is optimised to handle bass content better.
- ADAGIO This is better suited to slow orchestral material with long, sustained notes.

Each preset has three variations A, B and C. The A variations make a more general analysis of the original sound and although they process the selected region more quickly, the end result may not be as accurate as using either the B or C variations which make a more detailed analysis of the original material (but take slightly longer to process).

Q2 - ADJUST - provides access to the key parameters in any one preset and allows you to make adjustments to the preset with one, easy to use control.

Q3 - AMOUNT - allows you set the timestretch amount as a percentage with a range of 50% - 200% (100% is 'absolute' and represents no change).

F2 [SLIP on/off] allows you to select whether audio after the timestretch region will slip in time or not. The key is a simple ON/OFF switch with status being denoted by a simple (on) or (off).

Pressing PROCESS [F6] or the ENTER key will initiate the process. As with all the off-line DSP functions, this will process the edit region and will automatically replace the original with the new processed version.

If you don't like the results, you should press UNDO.

The quality of the processed result will depend on the type of source audio material, the selected Preset and the Adjust parameter. You might want to experiment with various Presets and different Adjust values to find the best settings for the audio that you are processing.

This becomes more noticeable when when increasing the amount over 100%.

When you press PROCESS [F6] or the ENTER key, you see this progress display:

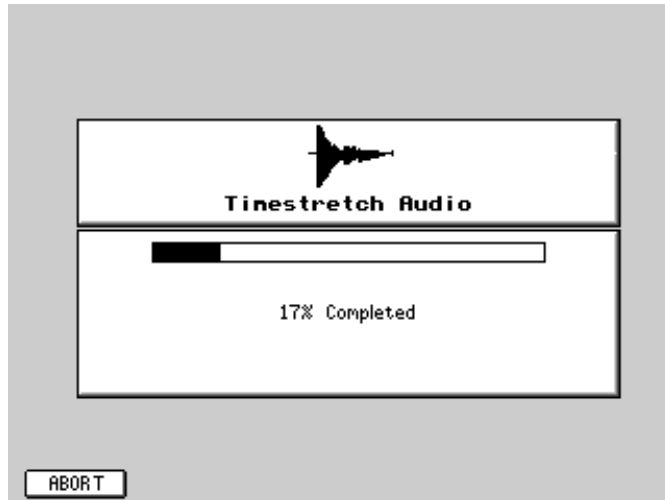

The process can be aborted at any time by pressing F1. This will leave the original untouched.

**NOTE:** This progress display is shown for all the off-line editing processes.

**PITCH SHIFT**

Allows you to change the pitch of the selected edit region without changing its length. Pressing PITCH [F2] displays this screen:

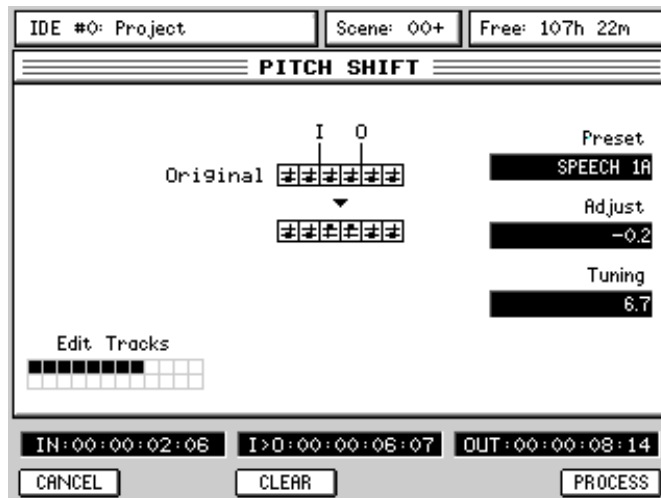

As in the TIMESTRETCH page, you may select a preset, adjust it manually. But instead of the stretch amount, here you set the tuning offset that you want to apply.

PROCESS [F6], or the ENTER key, initiates the process.

Because the length of the processed version doesn't change, the SLIP function key does not appear.

**BPM**

This allows you to match the selected edit region to another tempo without changing its pitch. This is exactly the same process as Timestretch, but this allows to enter a Tempo instead of an amount in %.

Pressing BPM [F3] displays this screen:

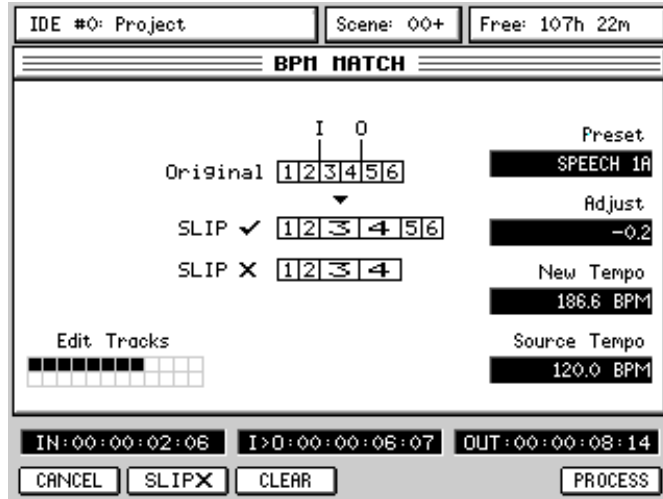

As in the TIMESTRETCH page, you may select a preset, adjust it manually.

To match tempi, you need to know the tempo of the original audio. This is entered in the SOURCE TEMPO field. You then need to set the tempo you want the edit region to play at in the NEW TEMPO field.

PROCESS [F6], or the ENTER key, initiates the process.

F2 [SLIP] allows you to select whether audio after the tempo-matched region will slip in time to accommodate the new length.

**VARI-SPEED**

Allows you to speed up/down the selected edit region. The audio will change pitch and length as though speeding up or slowing down a reel-to-reel tape machine.

Pressing VARI [F4] displays this screen:

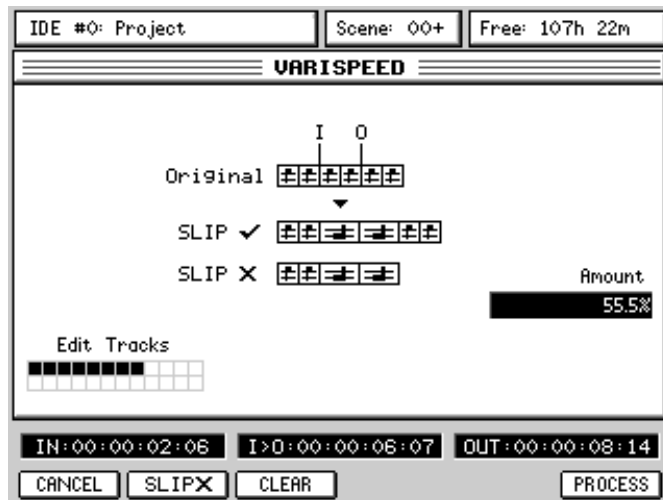

Here, you can only adjust the amount of varispeed using Q4.

Varispeed is a much simpler process than Timestretch or Pitch Shift and thus does not require to select a Preset nor Adjust.

PROCESS [F6], or the ENTER key, initiates the process.

F2 [SLIP] allows you to select whether audio after the processed region will slip in time to accommodate the varispeed.

Another application of the Varispeed feature is known as 'Rendering' (also known as 'Consolidate Audio').

By setting the Amount to 100%, the speed and pitch of the selected audio region will remain unchanged, but if the region is composed of several smaller cues (as a result of editing or multiple recording punches), this process will create one continuous audio file instead.

**REVERSE**

Allows you to reverse the selected edit region so that it plays backwards.

Pressing REVERSE [F5] displays this screen:

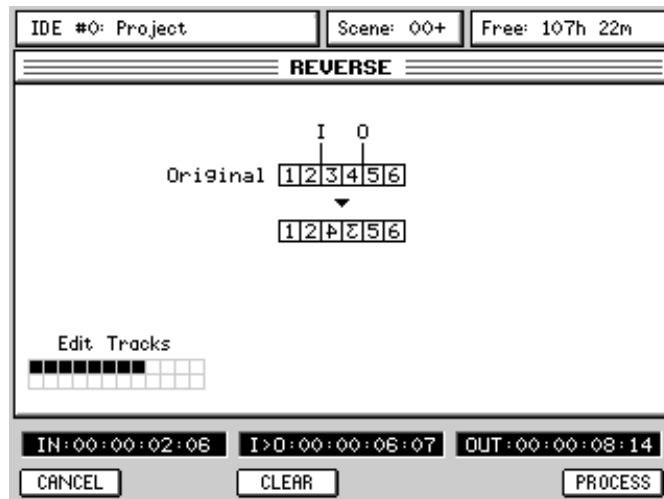

There are no parameters to adjust for this function.

Because the length of the processed version doesn't change, the SLIP function is not shown.

**NORMALISE** Allows you to normalise the selected edit region. The signal is analysed for its peak level and the edit region is then increased proportionally to obtain maximum level.

Pressing MORE [F6] followed by NORMAL [F1] displays this screen:

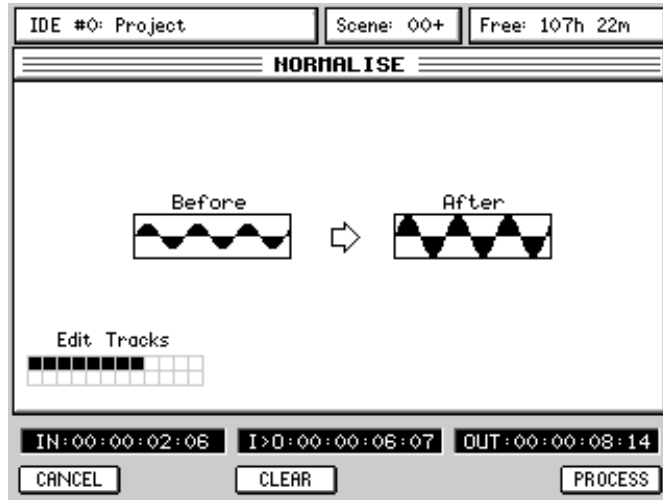

There are no parameters to adjust for this function and pressing PROCESS will simply normalise the selected edit region bring it to maximum level.

**NOTE:** When processing multiple tracks simultaneously, Normalising always normalises according to the loudest section of audio on any of the selected tracks, so if tracks 1, 2, 3, 4, 5 and 6 are normalised and there is a loud section on track 4, tracks 1, 2, 3, 5 and 6 will be normalised according to this audio level.

**RESAMPLE** Allows you to convert the sampling rate of the selected edit region. This also includes a dithering function to convert the Bit depth.

Pressing MORE [F6] followed by RESAMPLE [F2] displays this screen:

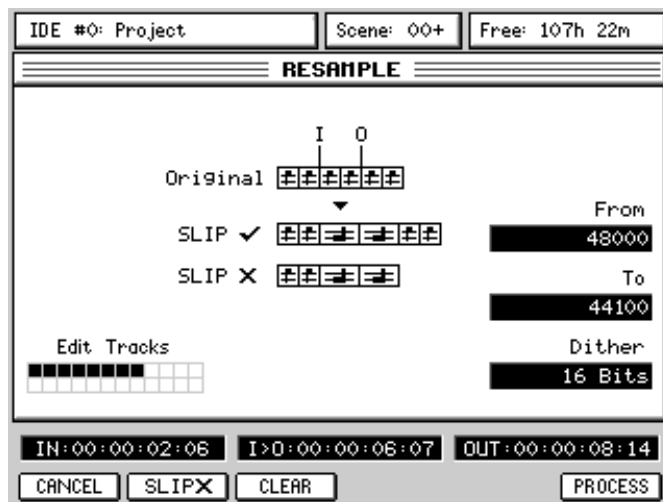

Here, you can set the original sample rate of the audio (From [Q3]) and the new sample rate that you want to convert to (To [Q4]).

Using Q5 [Dither], you can also change the bit depth of the selected audio. PROCESS [F6], or the ENTER key, initiates the process.

F2 [SLIP] allows you to select whether audio after the processed region will slip in time to accommodate the varispeed.

The main application of the Resample feature is to convert the sample rate of a region that is being pasted into a Project set at a different sample rate than the Project it was copied from.

This can also be used to dither a 44.1kHz/24bit stereo project down to 16bit before burning it to CD.

# MIXER MODE

Pressing the MIXER key shows this screen:

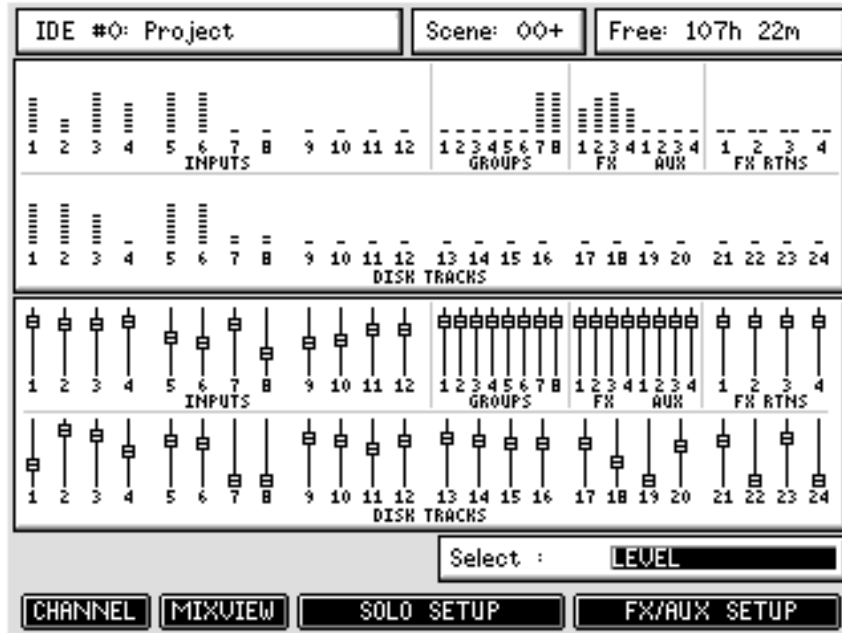

As in the MAIN screen, the top half of the MIXER screen shows the meters for the 12 inputs, 8 groups, 8 FX/AUX sends, 4 stereo FX returns and 24 disk tracks.

Under the meters block, you can see an overview of a selected parameter for all the channels. The displayed parameter is selected using Q6. The default parameter is LEVEL, showing the Fader position for all channels. This is useful as it allows you to see all faders in one glance, without having to switch Fader Banks. You may also view different parameters, such as Pan, Channel ON, FX/AUX Sends 1-4 or Stereo Linking.

Pan:

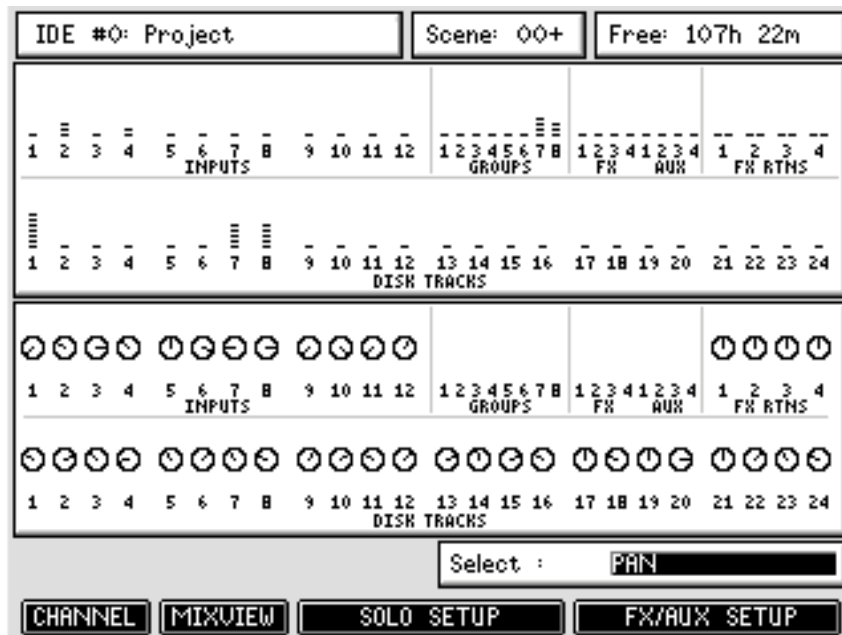



Channel ON (Mute):

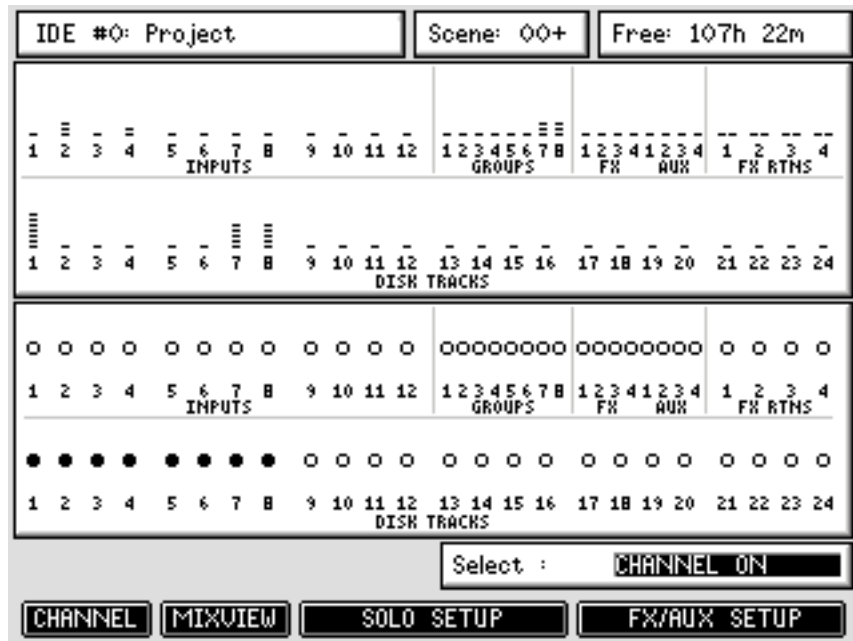

For this parameter, a clear circle indicates that the Channel is ON, while a black circle indicates that the Channel is OFF (muted).

FX/AUX Send:

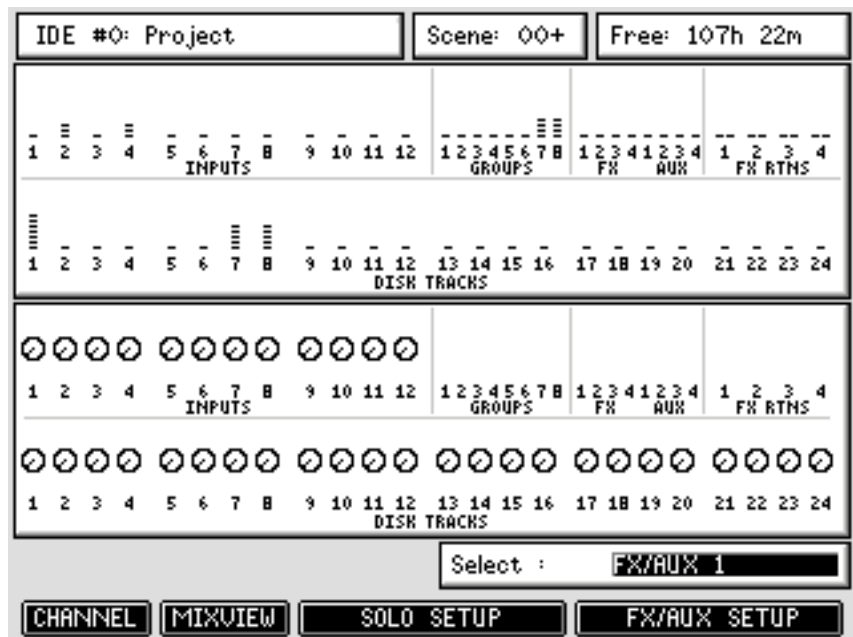

## MIXVIEW

To see a more detailed overview of the mixer's status, pressing MIXVIEW [F2] in the main MIXER page shows this:

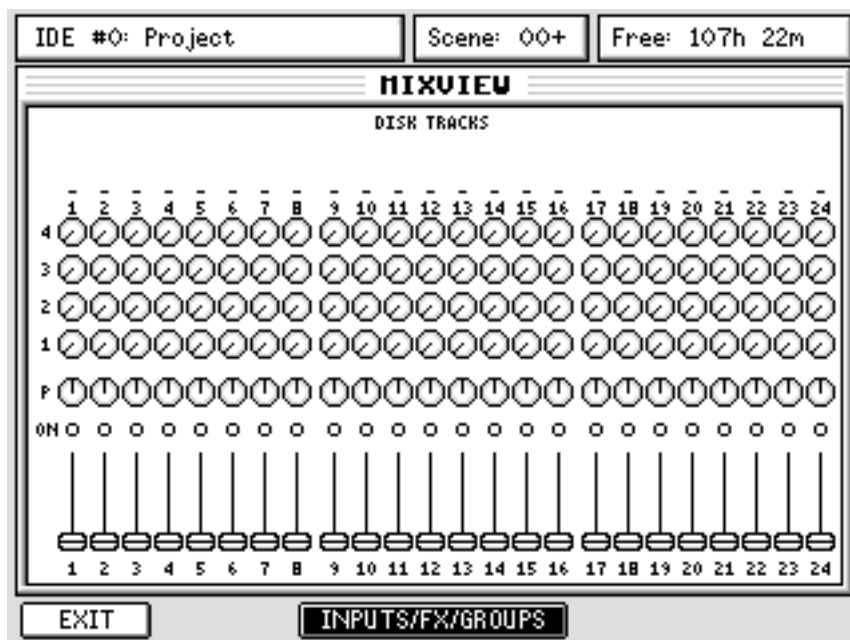

Here, you can see the level, pan, mute status and FX/Aux send levels for the 24 disk tracks.

Pressing INPUTS/FX/GROUP (F3/4) shows this screen:

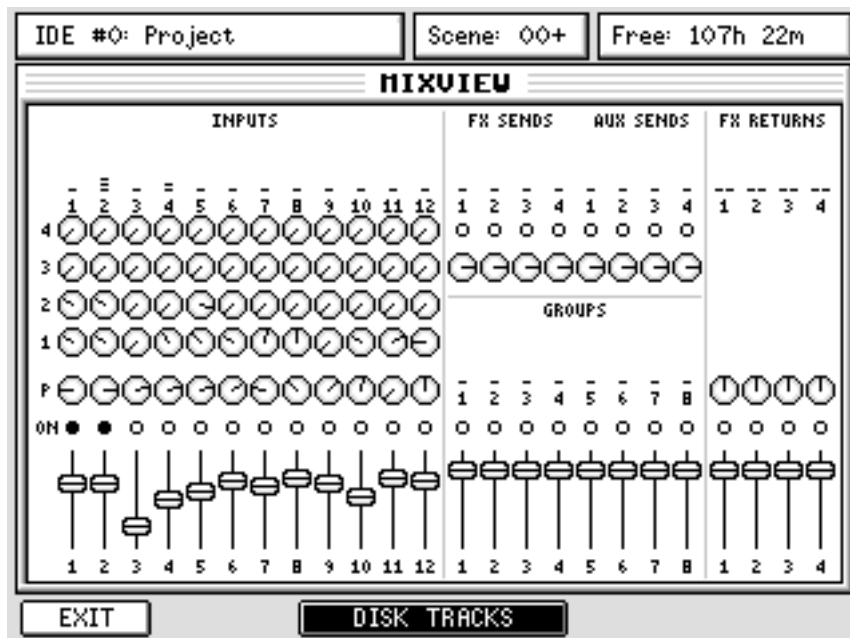

Here, you can see the same for the Inputs, FX/AUX send master levels, FX return and the 8 x Group sends. The master fader or L/R meters are not shown as these are always visible on the front panel. Neither of these pages are 'editable' as such - they merely reflect the controls' positions as set on the front panel and update in real-time as these controls are adjusted.

## CHANNEL

In the main MIXER page, pressing CHANNEL (F1) will show the settings for the selected channel.

**NOTE:** Enabling the Q-CHANNEL button automatically calls up the MIXER / CHANNEL page of the selected Channel on the LCD. Then, when disabling Q-CHANNEL, the display returns to the previous screen.

There are actually multiple Channel pages:

EQ Channel page

Dynamics Channel pages:

Compressor/Expander sub-page

Noise Gate sub-page

Channel Utilities page

There are also several Channel types. The Channel types are:

Input Channel (Mono)

Track Channel (Mono)

FX Return Channel (Stereo)

Aux L/R Input (Stereo)

Group

FX/AUX Master Send

Master Channel

MIDI Controller Channel

The Channel pages only show the parameters available for the type of selected channel.

For instance, only Mono Input or Track Channels have EQ and Dynamics controls.

The main EQ Channel page looks like this:

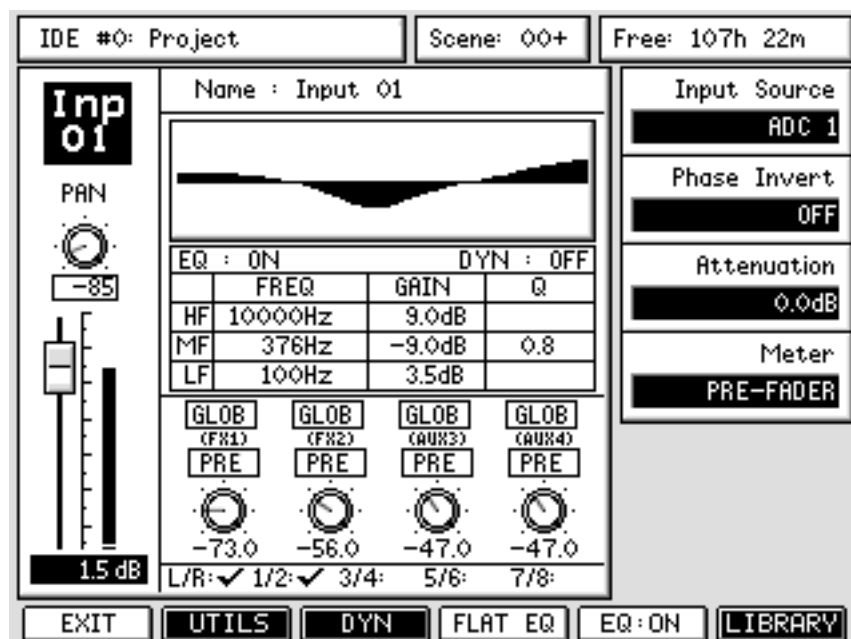

The main EQ Channel page is designed so that you can use the Q-Channel encoders to set the main parameters (pan, EQ, sends, etc.) and the Q-Link controls to set the others.

However, it is also possible to navigate the 'channel' window (i.e. pan, level, EQ, FX parameters) using the CURSOR keys or Q5. For the field that is selected by the cursor:

You can set precise values from the numeric keypad or using the DATA +/- keys.

You can also set values using the DATA ENTRY Q-Link control on Q6.

In the EQ Channel page, the Q-LINK parameters on the right of the page are as follows:

**INPUT SOURCE** If the selected channel is an Input channel, Q1 selects the input source.

The choices are:

ADC 1-12	FX 1 L
Digital In	FX 1 R
Digital In	FX 2 L
Aux In L	FX 2 R
Aux In R	FX 3 L
2-Track L	FX 3 R
2-Track R	FX 4 L
ADAT 1 - 8	FX 4 R
ADAT 9-24	METRO

In this way, you can patch any analogue or digital audio source to any input.

**RECORD SOURCE** If the selected channel is a Track channel, Q1 selects the Disk Record source.

The choices are the same as the Input Channel's Input sources, plus:

INP 1-12	Stereo L
Group 1-8	Stereo R
- - - -	(no assignment)

**INPUT SOURCE** If the selected channel is a stereo FX Return channel, Q1 selects the input source pair.

The choices are:

FX1 L+R	Digital In L+R
FX2 L+R	Aux In L+R
FX3 L+R	2-Track L+R
FX4 L+R	ADAT 1+2
ADC1+2	ADAT 3+4
ADC3+4	ADAT 5+6
ADC5+6	ADAT 7+8
ADC7+8	ADAT 9+10
ADC9+10	... up to ...
ADC11+12	ADAT 23+24

**PHASE INVERT** Q2 inverts the phase of the channel.

This is available only for Mono Input and Track Channels.

**ATTENUATION** Q3 is simple attenuator to compensate for any excessive gain boosts in the EQ.

This is available only for Mono Input and Track Channels.

**METER** Q4 allows you to set where in the audio chain you will view the meter shown to the right of the fader. The options are PRE-EQ, PRE-FADE and POST-FADE.

This is available only for Mono Input, Track and FX Return Channels.

**NOTE:** The *METER* setting is the same global setting as in the *MAIN/GRID* pages. It selects the type of metering for all channels, as well as in the *MAIN* screen and *Mixer* screen and *akSys*.

Q6 can be used to enter data as a conventional encoder, the idea being that you move the cursor to the appropriate field with the cursor keys or Q5, and use Q6 to set its value. However, you may find it easier to use the channel's actual control (fader, pan pot, FX/Aux send, EQ (in Q-Channel), etc..

You may also use the *DATA +/-* keys to 'nudge' values and you can also use the numeric keypad (followed by pressing *ENTER*) to enter parameter's value precisely.

**NOTE:** Some parameters do not have totally variable ranges. The *EQ* frequencies, for example, are actually a list of values - should you type in a certain value, the closest value will be chosen.

The blocks of parameters in the main section of the EQ Channel window are as follows:

NAME	Shows the name of the channel. The name defaults to the channel type and number (for instance, Input 12, V.Track 3, FX Return 01, Group 06, FX Send 01, ...) This can be changed by entering a 16-character name of your own choosing in the NAME window accessed from the channel Utilities page.
EQ CURVE	Shows a graphic representation of the EQ for the selected channel as it the EQ controls are adjusted.
EQ CONTROLS	Shows/allows you to set the EQ parameters: High Frequency and Gain Mid Frequency, Gain and Q Low frequency and Gain  The parameter values update as you use the Q-Channel controls or you may enter values directly as described above. The EQ can be bypassed using the Q-Channel's EQ ONkey or the EQ ON/OFF toggle [F4]. The EQ status is shown at the top left of this area.
DYN	Shows/switches the channel Dynamics status on or off.
PAN	Shows/sets the pan position for the selected channel.

**NOTE:** In the case of stereo channels such as the FX returns, this control acts as a balance control

LEVEL	Shows/sets the fader position for the selected channel. To its right you will see a level meter that shows incoming level. In addition, if Dynamics are active, a Gain Reduction meter will be shown to the right of the level meter, whenever gain reduction is applied. Where this meter derives its signal is determined by the <i>METER</i> parameter on Q5 and you can select to view the level pre-EQ (which is also pre-Dynamics), pre-fade or post fade.
-------	---

**FX/AUX SENDS** In this section you can set the FX/AUX send levels and you can also set whether the sends are pre-fader or post-fader.

Above the PRE/POST controls, it is possible to override the 'global' FX/AUX bus routing. In the main mixer's GLOBAL page, you can set whether FX/AUX1, 2, 3 and 4 go to the internal effects or to AUX buses 1-4. Here, however, it is possible to override these individually for each channel if you want.

When a channel uses the 'global' bus routing, "GLOB" is shown in this box. However, you can also select FXn, AUX n or OFF. For FX/AUX 3 and 4, you may also select STU L and STU R (i.e. the studio outputs) to set up a talkback/foldback monitoring mix. A practical example.....

In the GLOBAL page, FX/AUX1 is set to INTERNAL FX. When you select, say, Input channel 3, it will show GLOB and (FX1) - i.e. that channel is using the 'global' bus setting which is INTERNAL FX.

However, you can change this to AUX 1 - it will show AUX 1. All the other channels will show GLOB (FX1) for this send bus but you have individually overridden this on Input 3. The same can be done for other channels and sends, of course.

When a pair of sends are configured as a stereo send, the display changes.

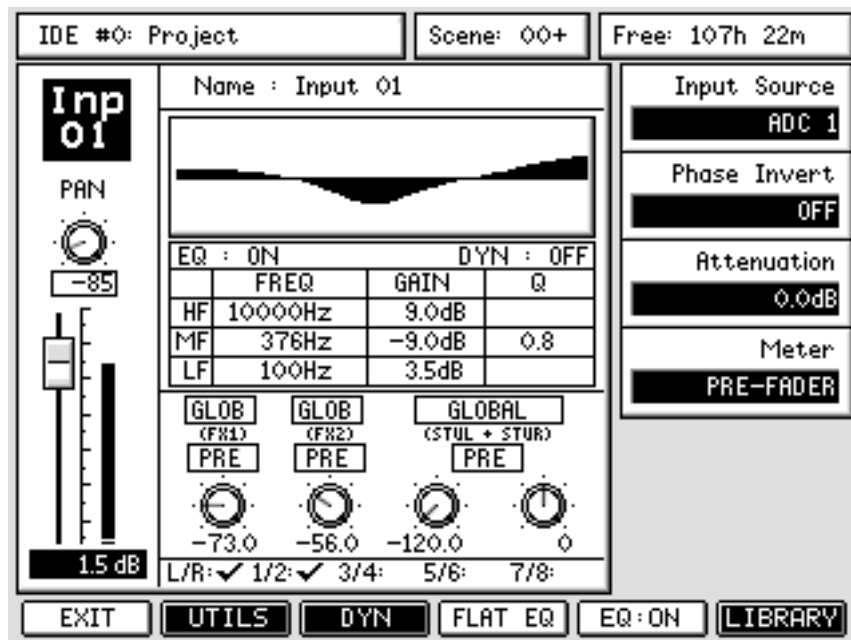

Here, AUX 3 and 4 are configured as a stereo send feeding the STUDIO outputs to facilitate a foldback mix for monitoring in a separate record area. For further information on setting up the FX/AUX routings, please refer to the relevant section later in this manual.

**NOTE:** By default, the FX/AUX sends for the FX return channels are switched off. This helps conserve mixer processing. However, you may switch these on if you need to send effects to other effects channels.

**GROUPS** Under the FX/AUX send section, you can see the group assignment for the selected channel. These may be changed in the PATCH pages or more conveniently directly on the console using the ASSIGN keys.

The soft key functions on the CHANNEL EQ page are:



- EXIT [F1] Takes you back to the main MIXER page.
- UTILS [F2] Takes you to the Mix Channel Utilities page (see below)
- DYN [F3] Takes you to a page where you can set the channel's dynamics processors (see below).
- FLAT EQ [F4] Will flatten the EQ but will leave other channel parameters intact.
- EQ:ON/OFF [F5] Allows you to toggle the EQ ON/OFF.
- LIBRARY [F6] Takes you to the EQ Library page. (see below)

Pressing UTILS [F2] takes you to the Mix Channel Utilities page:

- NAME Pops up a prompt where you can name the selected channel in the usual way.
- COPY Allows you to copy the settings of one channel to another.
- RESET Will initialise the selected channel(s) parameters to flat settings.

## CHANNEL DYNAMICS PROCESSOR

Each input and disk track has its own dynamics processor which is accessed in the DYN page:

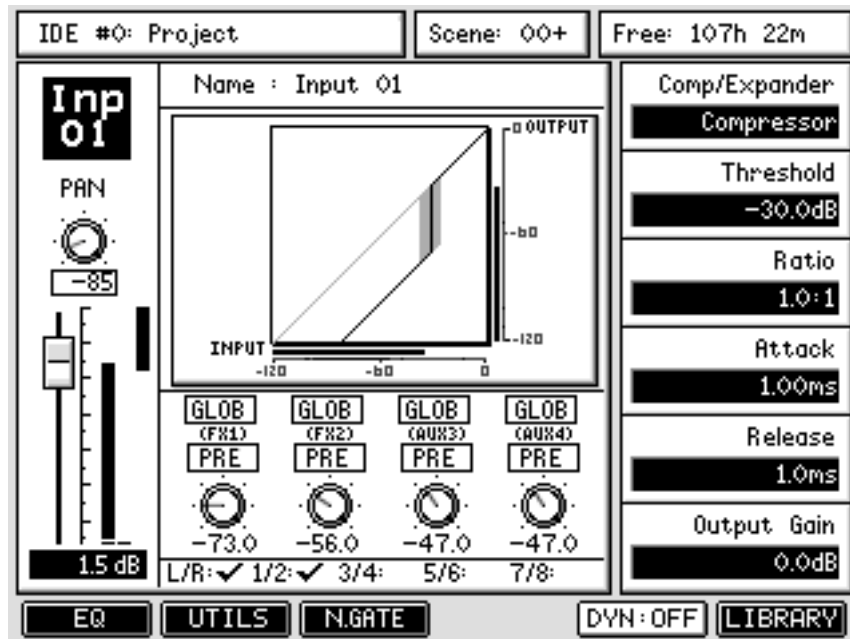

When in the Compressor or Noise Gate sub-pages, instead of the EQ curve and controls, you'll see a graphic designed to illustrate the effect of the chosen dynamics parameter values on the level of the audio passing through the selected channel.

The graph represents input signal level to the dynamics processing on the X axis vs output level from the dynamics processing on the Y axis. The linear scale of both axes is from -120dB to 0dB relative to digital full scale. Meters along the X and Y axes show the actual input and output signal levels from the channel's dynamics processing unit, on the same scale as the graph's axes.

The grey parallelogram on the graph represents the noise gate's hysteresis setting. If this parameter is set at or close to 0dB the grey block will not be shown.

The Compressor/Expander parameters are:

- |               |  |
|---------------|--|
| COMP/EXPANDER | Allows you to select whether the processor is a compressor or an expander.   |
| THRESHOLD     | Sets the level at which the compressor starts to work. Signals below this level pass through the compressor unaffected - signals above the threshold level are processed according to the settings made below.   |
| RATIO         | Sets the compression ratio (1:1 > 1:100). When set to 1:100, the compressor acts as a limiter.   |
| ATTACK        | Sets the period of time before the compressor kicks in. With a fast attack, the signal is processed almost immediately but with longer attack times, the initial part of the sound can be allowed to pass through unaffected thus preserving any transients. |
| RELEASE       | Sets the release time of the compressor (i.e. the time it takes to drop to normal gain once the signal has dropped below the threshold).   |
| OUTPUT GAIN   | Makes up for any gain reduction that may occur in the compression process.   |



Pressing N.GATE [F3] shows the following screen:

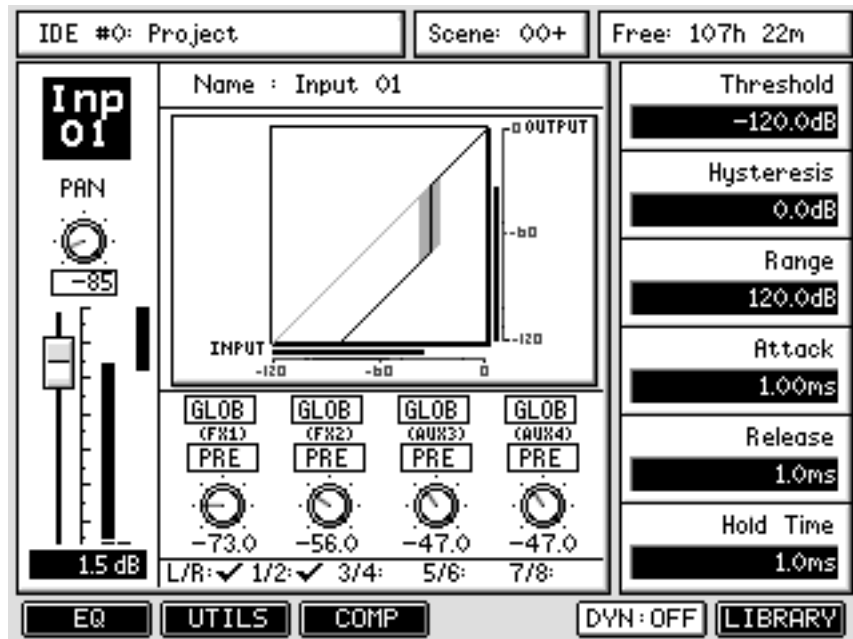

The parameters are:

THRESHOLD	Sets the threshold for the noise gate.
HYSTERESIS	Smooths the closure of the gate and prevents 'chatter' if the gate is rapidly opening and closing with a decaying signal around the threshold level.
RANGE	Allows a certain proportion of the signal to always pass through. Normally, this will be set low so that no signal passes through but setting a slightly higher range can be useful if the gating effect is too abrupt.
ATTACK	Sets the length of time it takes for the gate to open. Typically, this will be set to 0ms.
RELEASE	Set the time it takes for the gate to decay to the threshold level.
HOLD	Determines the length of time the gate is open after the attack cycle has reached full level.

In the Compressor/Noise Gate sub-pages, EQ ON/OFF key [F5] is replaced with DYN ON OFF, which allows you to quickly bypass the Dynamics processors.



F1 [EQ] returns to the main EQ Channel page.

F2 [UTILS] takes you to the Channel Utilities page.

F3 is used to toggle between the COMP and N.GATE sub-pages.

## EQ / COMPRESSOR / GATE PRESET LIBRARIES

EQ/Compressor/Gate preset libraries provide a convenient way to store and recall your favourite channel processing parameters for use on another channel, or even in another project. We've provided a number of factory presets that you can recall and tweak to suit your own needs.

The LIBRARY [F6] key on the channel page will take you to the preset library for the parameters you're viewing, so pressing the LIBRARY key on the EQ page will take you to the EQ preset library.

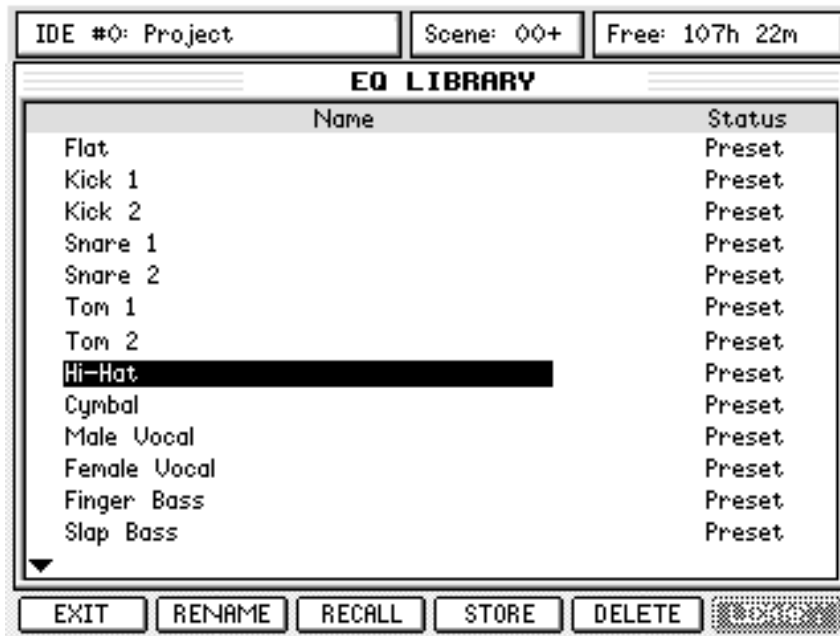

In the EQ preset library page, simply choose the preset you would like to recall and press the RECALL button (F3). You will be returned to the channel page and the EQ will be applied:

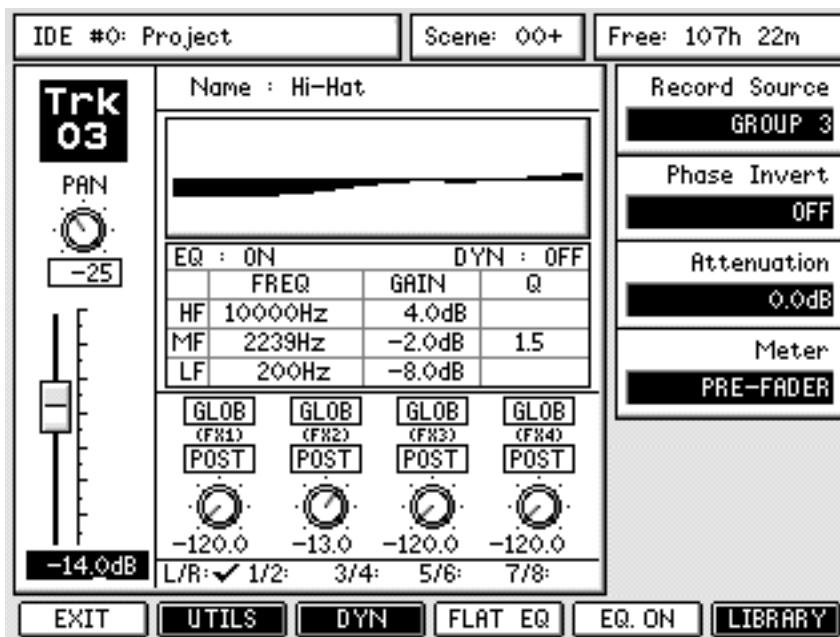

The Compressor and Noise Gate preset libraries are used in exactly the same way. Let's look now at how to store Noise Gate settings as a User preset.

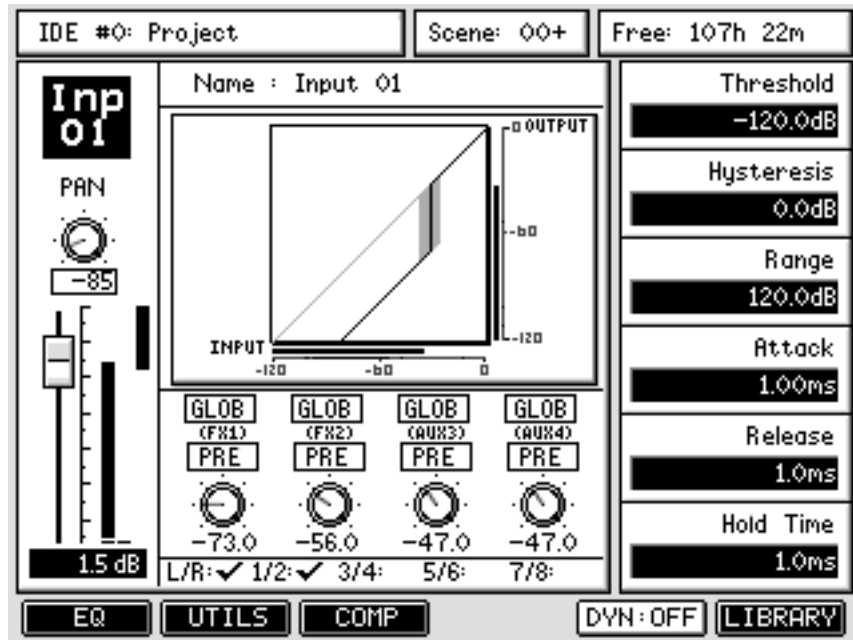

Pressing the LIBRARY button while looking at the Noise Gate parameters will take you to the Noise Gate preset library:

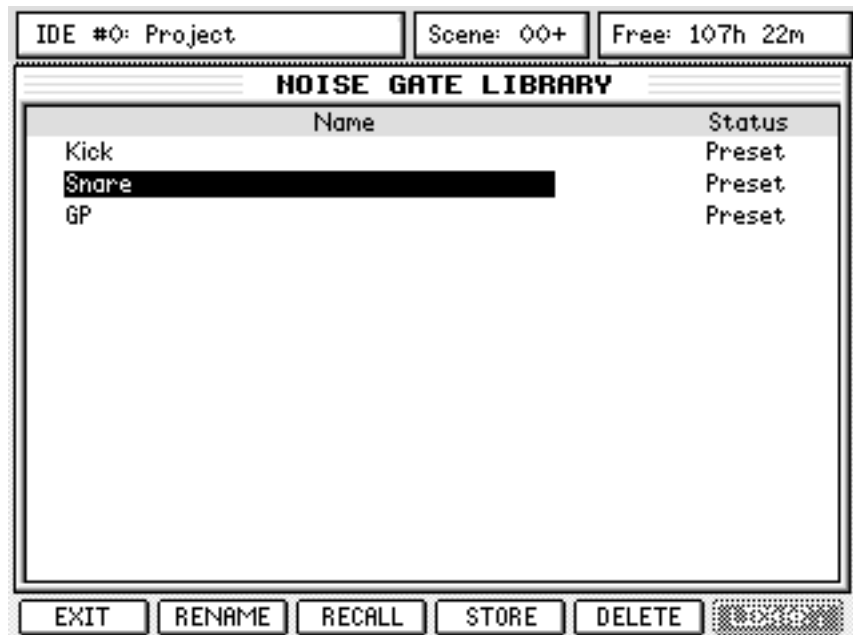

**NOTE:** If the Compressor parameters are on the screen, the LIBRARY button on F6 will access the Compressor preset library. Similarly for the EQ library - on the main mixer channel page, pressing LIBRARY will take you to the EQ library page.

Press the STORE button to store the current noise gate settings as a new User preset. You will see this screen:

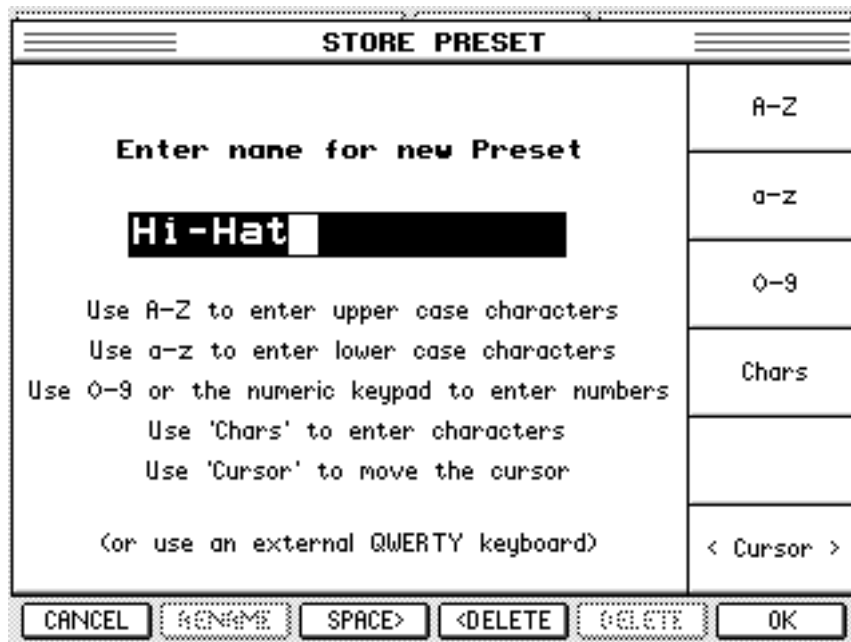

Give the preset a name (the name must be unique to the Noise Gate preset library) and press OK - the preset is stored for future use:

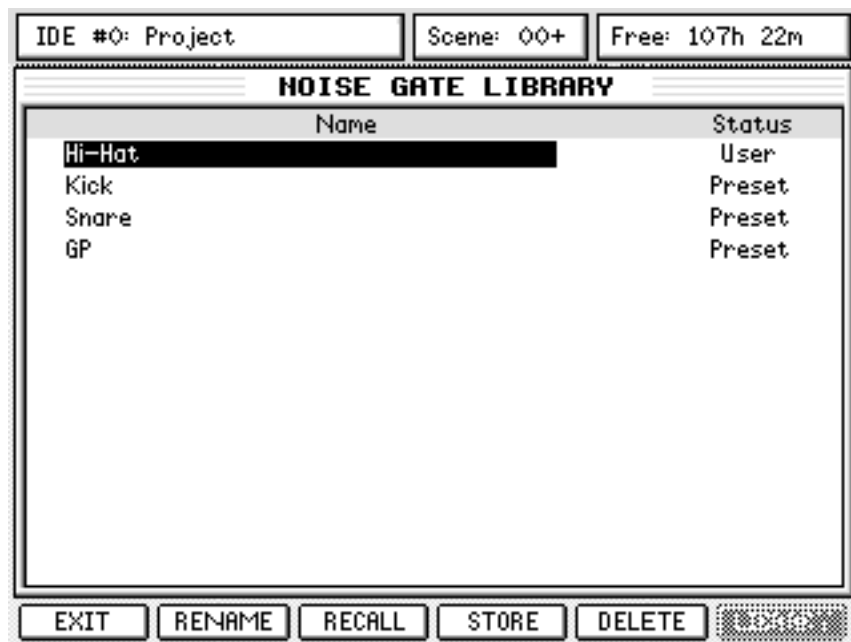

**NOTE:** This will only store the Noise Gate settings \_ Compressor presets are stored in a separate library.

## EQ AND DYNAMICS SNAPSHOTS

In addition to using the global EQ, Compressor and Noise Gate preset libraries to share presets between channels and projects, you can also store snapshots of channel EQ or Dynamics (Compressor + Noise Gate) settings in each project. Recall of these snapshots to any channel can be recorded and played back by the DPS24's automation system. EQ and dynamics snapshots work in exactly the same way, so you only have to learn this once!

We'll take a look at how to make a Dynamics snapshot from one track to another. Of course, the source and destination channels are arbitrary – these operations will work with any channel that has dynamics processing. First, select the source channel from which you want to store the dynamics snapshot by pressing its SELECT button (for example, Track3). Then press the MIX SCENE STORE button to display this page.

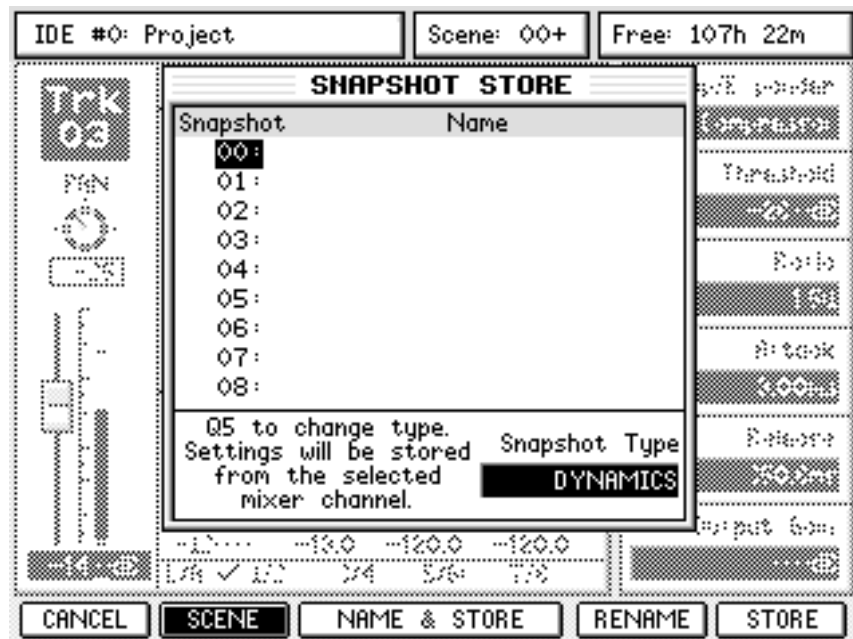

Select the snapshot ID you would like to store to with the cursor keys (or use Q6 to scroll up and down the list if you prefer) and press STORE (F6) or ENTER.

**NOTE 1:** The Scene/Snapshot Store and Recall pages are context-sensitive. For example, if you press MIX SCENE STORE while in the Mixer Channel DYN sub-page the SNAPSHOT STORE window will appear with the Snapshot Type set to DYNAMICS.

However, once in the Scene/Snapshot Store or Recall page, you can switch between SCENE and SNAPSHOT mode and between Snapshot Types manually using the SCENE/SNAPSHOT button (F2) and Q5 knob respectively

To recall the snapshot onto another channel, select the 'destination' channel by pressing its SELECT button. For example, selecting Track 4 will show (something like) this:

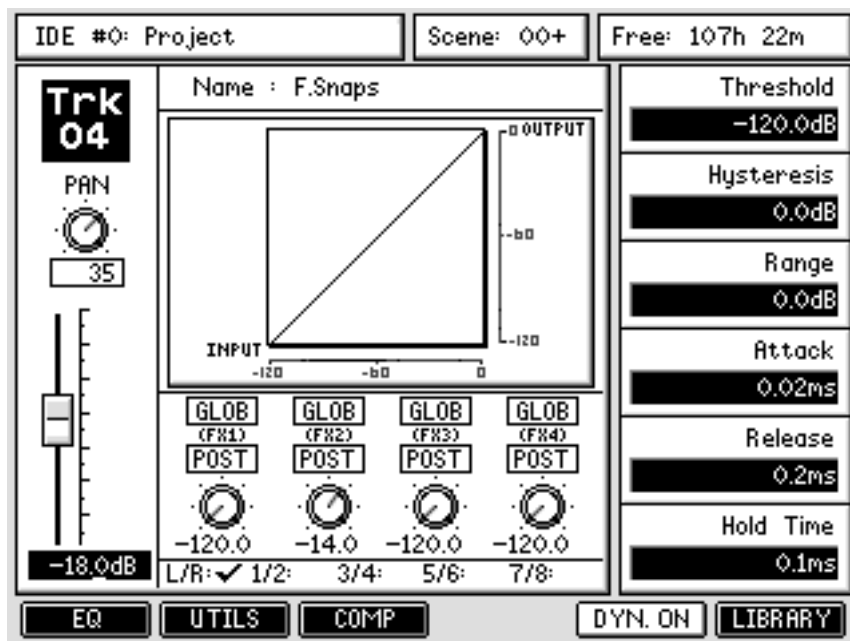

Press the MIX SCENE RECALL button to display the SNAPSHOT RECALL page:

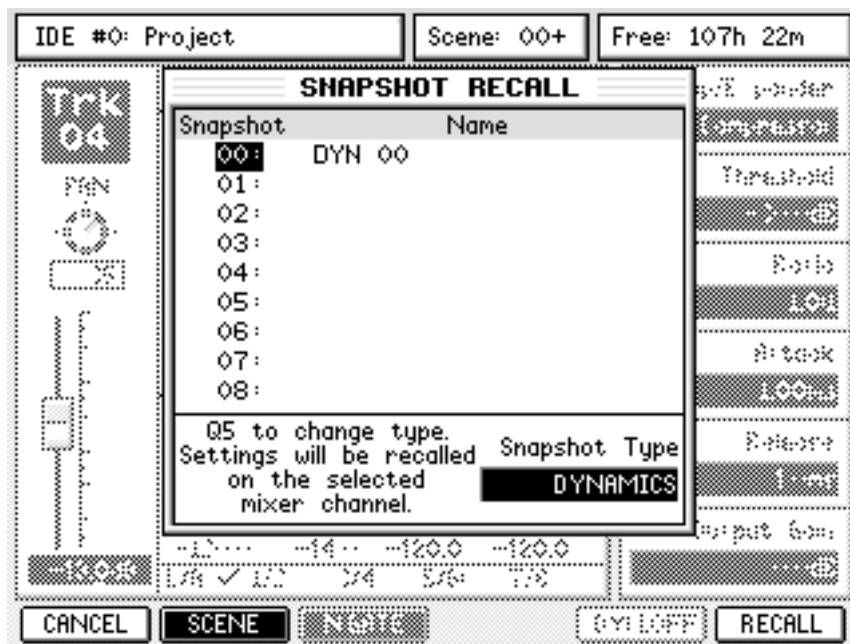

Now select the snapshot you just stored. Press RECALL (F6) or ENTER to recall the snapshot.

**NOTE:** You don't have to have the channel page on the screen to store and recall Dynamics and EQ snapshots \_ it just makes explaining it easier, but the snapshots will always be stored from and recalled to the selected mixer channel (Q-Channel) regardless of the page displayed on-screen.

Now Track4 has the dynamics settings we stored earlier from Track3.

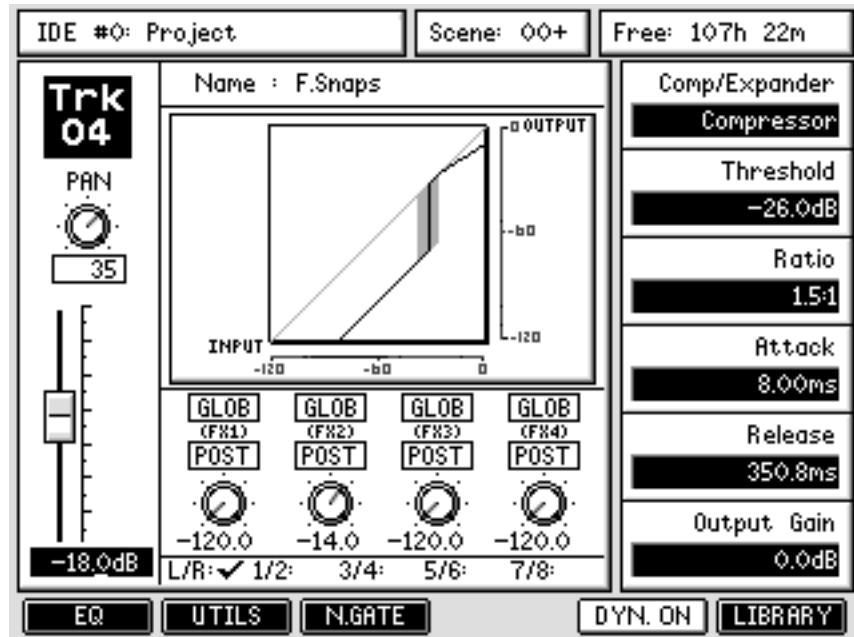

**NOTE:** To store EQ or Dynamics presets from the global libraries as an automate-able snapshot, simply recall the chosen preset onto a mixer channel then store it as a snapshot.

Conversely, storing snapshots into the global preset libraries can be achieved by recalling the snapshot onto a mixer channel then storing the recalled settings as a preset. However, bear in mind that the Dynamics snapshot stores both Compressor and Noise Gate settings, but the Compressor and Noise Gate preset libraries are separate.

## STEREO CHANNELS

Channels can be linked to act as a stereo pair. This is achieved simply by pressing and holding an odd numbered channel's SELECT key and pressing an adjacent even numbered channel or vice versa..

**NOTE:** When two channels are linked as stereo and one channel's parameters are different to the other, one channel will adopt the settings of the other. This is achieved according to the order in which you press the channel SELECT keys. For example, if you press the even numbered channel first and then the odd numbered channel, the even numbered channel's settings will be copied to the odd numbered channel and the even numbered channel's automation data will be used. If you press the odd numbered channel first and then the even numbered channel, the odd numbered channel's parameters will be copied across to the adjacent even numbered channel and the odd numbered channel's automation will be used.

When two channels are linked as stereo, anything you do on one channel will be reflected on the other (including level, EQ, FX/Aux sends). However, some parameters remain independent.

These are Pan, input source, phase invert and attenuation.

The channel's dynamics processors are similarly linked and any setting you make to one will be reflected in the other. However, when a pair of channels are linked, the channels' sidechains are linked.

**NOTE:** When a stereo linked pair of channels are selected, this is indicated by having an asterisk (\*) appended to the channel number - e.g. INP 01 becomes INP 01\* when linked to INP 02:

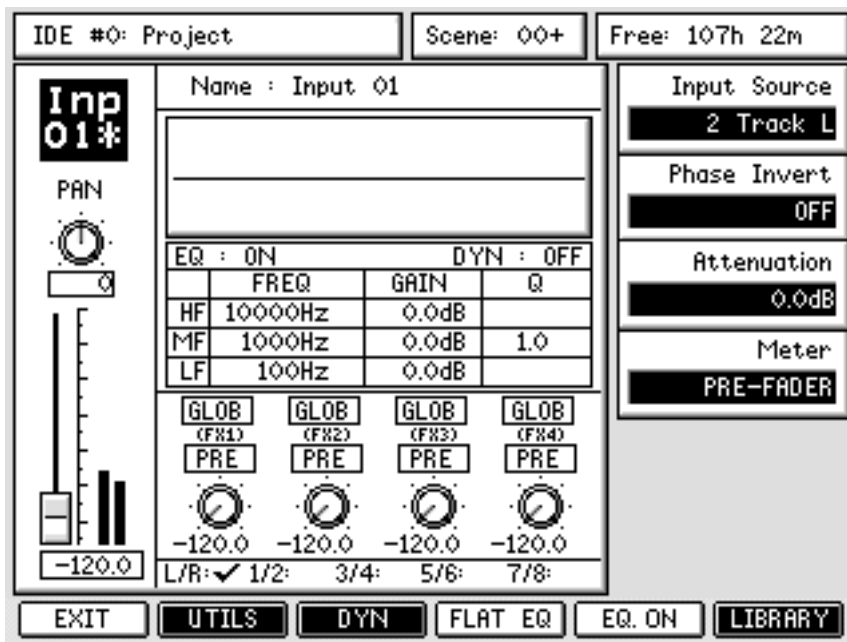



## SOLO SETUP

Back in the main MIXER mode page, pressing SOLO.SET [F3] takes you to the SOLO SETUP screen where you can set how the SOLO keys will function for the Monitor outputs.

The different SOLO modes are selected using F3 - F6.:

**PFL** Pre Fade Listen - monitors the signal before the fader and ON switch.

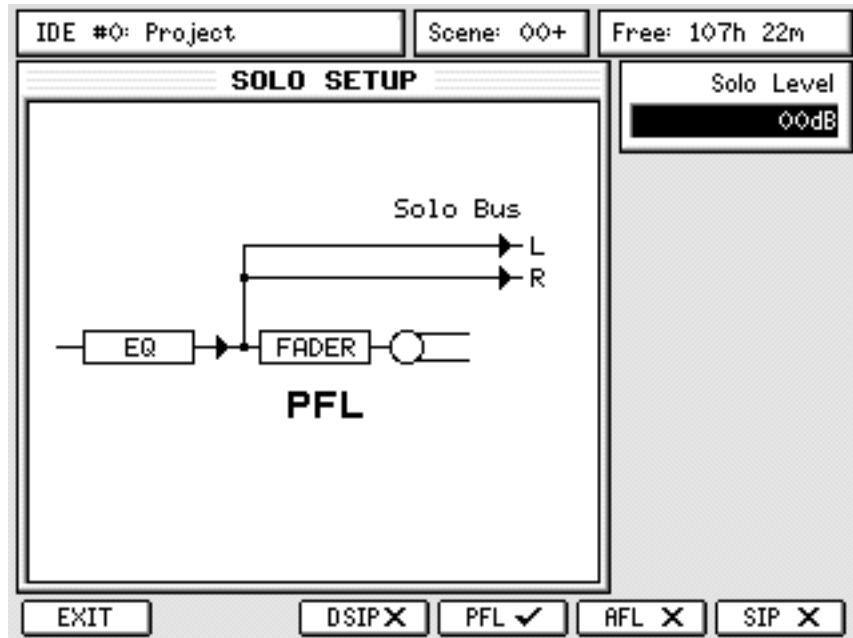

**AFL** After Fade Listen - monitors the signal after the fader and ON switch.

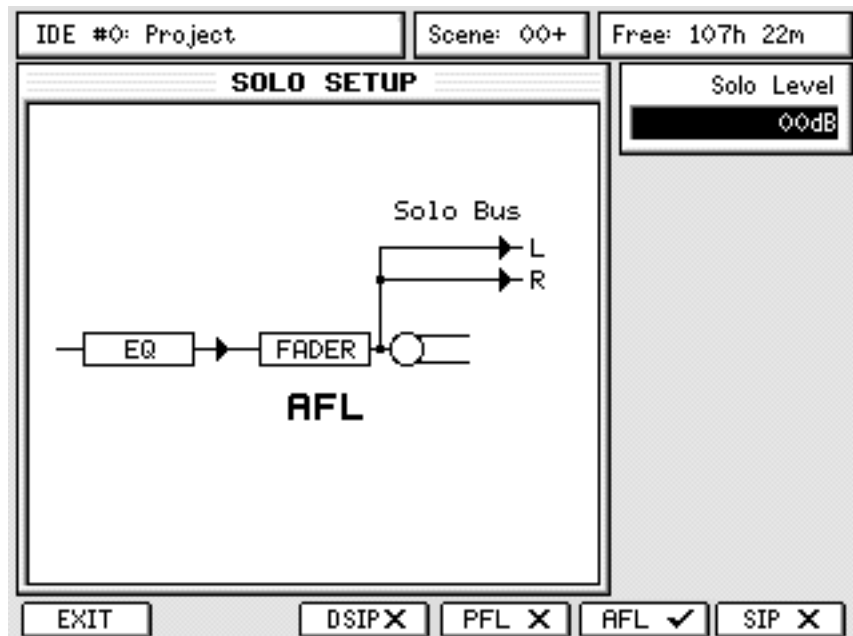

SIP Solo In Place - monitors the signal after the channel's Pan pot thus allowing you to hear it in its stereo position.

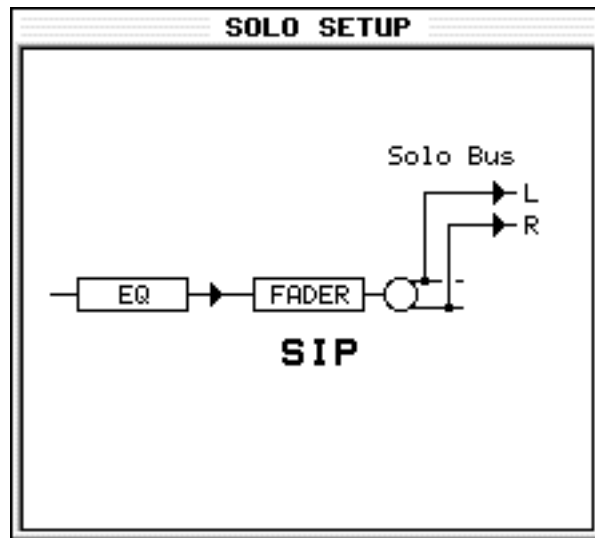

DSIP Destructive Solo In Place - also after the channel's Pan pot. All channels not in solo are muted, including in the Stereo outputs.

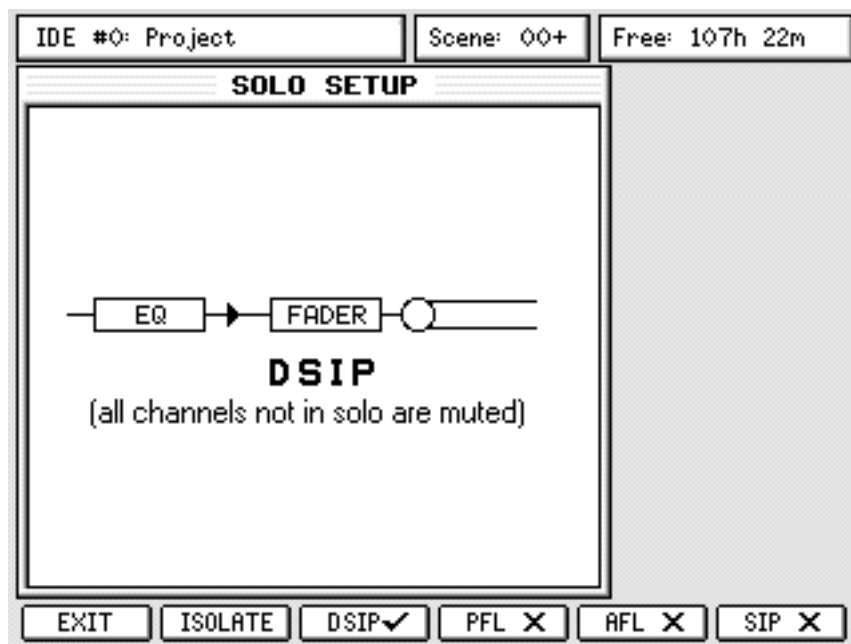

Sometimes, when soloing a channel, it is useful to solo it in the context of any effects that may be applied to it. For example, you may have a guitar part recorded to which you have added chorus, delay and reverb. Normally, when you solo the guitar channel, that's all you'll here... the guitar ... without effects.

With DSIP, it is possible to isolate the FX return channels so that when you solo the guitar, the FX returns won't be muted and you will hear all the treatments applied to that channel. Note that because all other channels are muted, you won't hear the effects that may be applied to other channels... all you will hear are the effects as they are applied to the solo'd channel.

You can isolate the channels that you don't want to be solo'd when SOLO is pressed using the ISOLATE key on F2. Pressing this will show this screen:

IDE #0: Project	Scene: 00+	Free: 107h 22m
<b>SOLO SETUP</b>		
SOLO ISOLATE		
GROUPS		
<input checked="" type="checkbox"/> <input checked="" type="checkbox"/> <input checked="" type="checkbox"/> <input checked="" type="checkbox"/> <input checked="" type="checkbox"/> <input checked="" type="checkbox"/> <input checked="" type="checkbox"/> <input checked="" type="checkbox"/>		
1 2 3 4 5 6 7 8		
FX SEND		AUX SEND
<input checked="" type="checkbox"/> <input checked="" type="checkbox"/> <input checked="" type="checkbox"/> <input checked="" type="checkbox"/>		<input checked="" type="checkbox"/> <input checked="" type="checkbox"/> <input checked="" type="checkbox"/> <input checked="" type="checkbox"/>
1 2 3 4		1 2 3 4
AUX IN		FX RTN
<input checked="" type="checkbox"/>		<input checked="" type="checkbox"/> <input checked="" type="checkbox"/> <input checked="" type="checkbox"/> <input checked="" type="checkbox"/>
1		1 2 3 4
Use CURSOR keys and DATA +/-		
EXIT	MORE	DSIP <input checked="" type="checkbox"/>
PFL <input checked="" type="checkbox"/>	AFL <input checked="" type="checkbox"/>	SIP <input checked="" type="checkbox"/>

Pressing MORE on F2 will show this screen:

IDE #0: Project	Scene: 00+	Free: 107h 22m
<b>SOLO SETUP</b>		
SOLO ISOLATE		
INPUTS		
<input checked="" type="checkbox"/> <input type="checkbox"/> <input type="checkbox"/> <input type="checkbox"/> <input type="checkbox"/> <input type="checkbox"/> <input type="checkbox"/> <input type="checkbox"/> <input type="checkbox"/> <input type="checkbox"/> <input type="checkbox"/> <input type="checkbox"/>		
1 2 3 4 5 6 7 8 9 10 11 12		
DISK TRACKS		
<input type="checkbox"/> <input type="checkbox"/> <input type="checkbox"/> <input type="checkbox"/> <input type="checkbox"/> <input type="checkbox"/> <input type="checkbox"/> <input type="checkbox"/> <input type="checkbox"/> <input type="checkbox"/> <input type="checkbox"/> <input type="checkbox"/>		
1 2 3 4 5 6 7 8 9 10 11 12		
<input type="checkbox"/> <input type="checkbox"/> <input type="checkbox"/> <input type="checkbox"/> <input type="checkbox"/> <input type="checkbox"/> <input type="checkbox"/> <input type="checkbox"/> <input type="checkbox"/> <input type="checkbox"/> <input type="checkbox"/> <input type="checkbox"/>		
13 14 15 16 17 18 19 20 21 22 23 24		
Use CURSOR keys and DATA +/-		
EXIT	MORE	DSIP <input checked="" type="checkbox"/>
PFL <input checked="" type="checkbox"/>	AFL <input checked="" type="checkbox"/>	SIP <input checked="" type="checkbox"/>

Those channels that are 'ticked' will not be muted when another channel is solo'd.

Please note one important difference between this SOLO mode and the others... the clue is in the word 'destructive' (and the block diagram in the above screen).

With the other SOLO modes (PFL, AFL and SIP), these merely affect what you hear on the MAIN and NEAR monitor outputs. In other words, you can solo channels whilst you are mixing down through the MASTER STEREO OUTPUT and the master stereo mix will not be affected.

However, with DSIP selected as the SOLO mode, soloing a channel will affect what's heard on the MASTER STEREO OUTPUT. So, you're mastering your project to an external 2-track through the MASTER STEREO OUTPUT and you solo that guitar channel just to check it. You hear it in isolation and all is well so you 'un-solo' it. Fine... no problem except....

When you listen back to your master mix on the external 2-track, that solo action will have been recorded! Please be aware of this when using DSIP.

In all SOLO modes except DSIP, a SOLO LEVEL parameter on Q1 sets the level of the solo'd signal. This is most useful when PFL is selected (i.e. the signal appears at full level) to prevent the solo'd signal blowing your speakers!

The SOLO setting affects all channels equally and is not specific to any given channel.

## USING SOLO

To solo a channel, simply press SHIFT+CHANNEL ON. The key will flash to indicate that the channel is solo'd (and the !!! SOLO !!! LED in the MONITOR section will also flash as added confirmation that a channel is solo'd). To turn SOLO off, simply press the key again.

However, as soon as you solo any channel, you enter a solo 'mode'. In this mode....

- To add other channels to the SOLO 'mix', simply press their CHANNEL ON key.
- To hear another channel in isolation whilst other channels are solo'd, use SHIFT+CHANNEL ON - this will solo the newly selected channel in isolation and override previous SOLO selections.

**NOTE:** In the case where you have multiple channels solo'd, a quick way to clear them all is to press SHIFT+CHANNEL ON followed by CHANNEL ON again on the same channel. All solo'd channels will be cancelled.

## FX/AUX SETUP

Pressing FX/AUX SETUP [F5/F6] in the main MIXER page shows this screen:

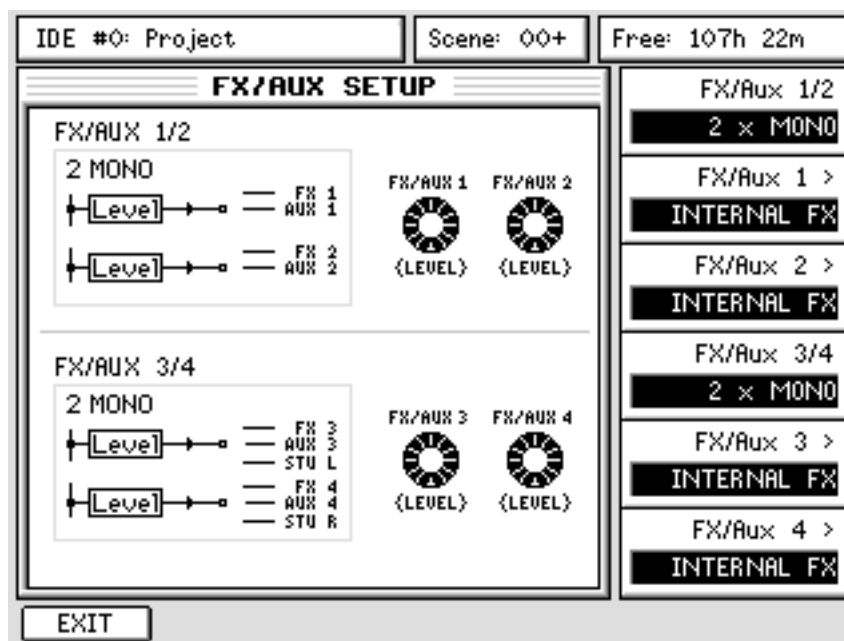

Here you can set up the configuration of the FX/Aux busses. The Q-Link functions are:

**FX/AUX 1/2** Allows you to configure FX/AUX 1/2 as two mono sends or one stereo send. When configured as STEREO, the graphics change

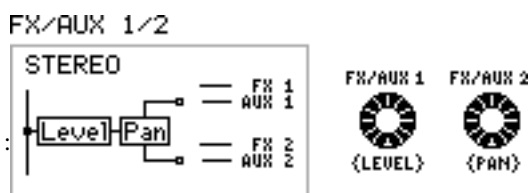

The control normally used to set the send level for FX1/Aux 1 now sets the level for the stereo send and the control normally used to set the send level for FX/Aux 2 now sets the send's stereo pan position.

**NOTE:** There is not much point in setting these sends to stereo when using the internal effects as all the internal effects have a mono input. However, you could use a stereo send and use the pan control (FX/Aux 2) to 'morph' between the two channels. That you can also automate the movement of the pan control means that some special effects could be created.

**FX/AUX 1 >** Allows you to route the FX/Aux send to the INTERNAL FX or to the AUX busses. The send may also be switched off.

**FX/AUX 2 >** As for FX/Aux 1 but, of course, for FX/Aux 2

FX/AUX 3/4 are virtually identical to FX/AUX 1/2 except that they can also be routed to the STUDIO L and/or STUDIO R bus. Typically, these are used to set up a foldback monitoring system (aka Cue Mix) for recording in a separate studio area.

Using the mono/stereo option for the sends, you can create various different foldback configurations and you can have the following setups:

- 1 x mono foldback mix on either AUX 3 or AUX 4.
- 2 x independent mono foldback sends each with a separate mix on each send.
- 1 x stereo foldback mix with control of level and pan for each channel allowing you to set a stereo mix in the STUDIO outputs. This is the most common setting for this application.

**NOTE:** When *STUDIO L* is selected, *AUX 3's* output is muted. Similarly, when *STUDIO R* is used, *AUX 4's* output is muted.

## TALKBACK TO STUDIO OUT

The DPS24's internal talkback mic is permanently hardwired to the STUDIO outputs and is activated using the TALKBACK button located above the MASTER fader.

The level of the talkback mic can be adjusted with the TB LEVEL pot just under the built-in mic.

**NOTE:** The talkback mic only appears at the *STUDIO L* and/or *R* outputs when they are enabled in the *FX/AUX SETUP* page. The talkback mic will not be heard through the *FX/AUX 3/4* busses if they are routed to the internal effects or the *AUX* bus.

# PATCH MODE

Pressing SHIFT+MIXER takes you to the PATCH mode where you can route external and internal audio around the DPS24. The first page you see is the CHANNEL SOURCES:

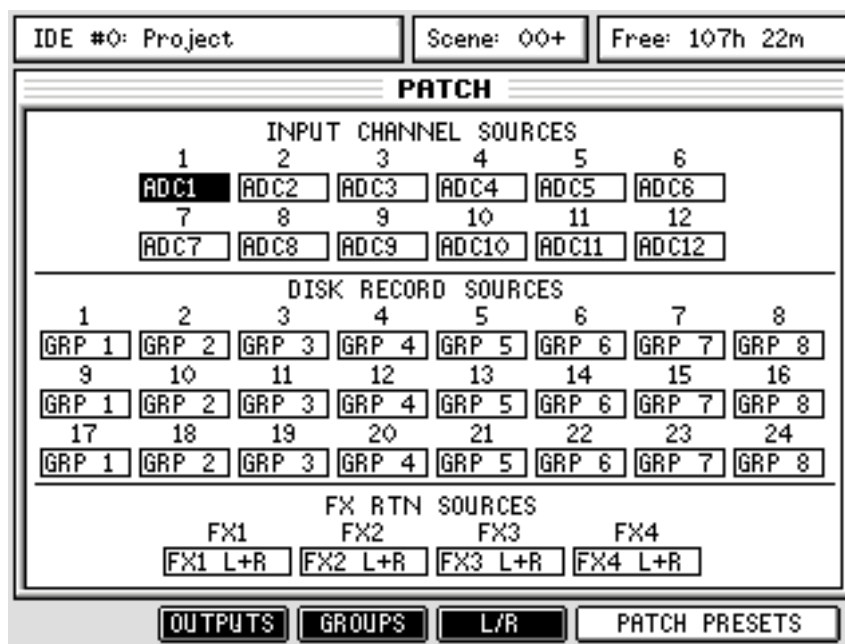

## SOURCE

The INPUT CHANNEL SOURCES fields at the top of the screen allow you to select the input source for each of the 12 input channels. The choices are:

ADC 1-12 - default	FX1 L
Digital In L	FX1 R
Digital In R	FX2 L
Aux In L	FX2 R
Aux In R	FX3 L
2-Track L	FX3 R
2-Track R	FX4 L
ADAT 1 - 8	FX4 R
ADAT 9-24 (with IB-24ADT option board installed)	
METRONOME	

In this way, you can patch any analogue or digital audio source to any channel. The default for each input is to have as its source a corresponding ADC. However, these can be changed to your own requirements. It also allows the input channels to be used for mixing audio sources other than analogue inputs.

For example, you could patch in the internal FX outputs into two input channels so that they can be EQ'd, compressed, gated, etc.. Similarly you could patch in a CD or DAT or other stereo digital audio source via the Digital In L/R inputs.

If you have an Akai S5/6000 with the optional ADAT board fitted, you can patch the ADAT inputs to the channels to have a digital feed of the sampler's individual outputs.

Assignments in this page (and all the other PATCH pages) are made by using the cursor keys to move to the appropriate box and then using the DATA +/- keys to select your options.

The DISK RECORD SOURCES allow you to select audio sources to be recorded to the disk tracks. The source options are

INPUTS 1-12	Stereo bus L
GROUPS 1-8 - default	Stereo bus R
ADC 1-12	METRONOME
Digital In L	FX1L
Digital In R	FX1R
Aux In L	FX2L
Aux In R	FX2R
2-Track L	FX3L
2-Track R	FX3R
ADAT 1 - 8	FX4L
ADAT 9-24 (with IB-24ADT option board installed)	FX4R
----- (no assignment)	

This flexible assignment allows many possibilities. For example, you could patch the ADCs directly to the track inputs. Not only would this provide very clean, unprocessed recording direct to disk but would also free up the 12 input mix channels for other audio sources such as ADAT (the digital individual outputs of an S5/6000 for example).

The stereo FX RTN SOURCES allow you to configure the FX RETURNS channels. The source options are:

FX1 L+R	(the stereo outputs of Internal FX1) - default
FX2 L+R	(the stereo outputs of Internal FX2) - default
FX3 L+R	(the stereo outputs of Internal FX3) - default
FX4 L+R	(the stereo outputs of Internal FX4) - default
ADCs 1+2, 3+4, 5+6, 7+8	
Digital In L+R	
Aux In L+R	
2-Track L+R	
ADAT 1+2, 3+4, 5+6, 7+8	
ADAT 9+10, ... up to ... 23+24 (with IB-24ADT option board installed)	
----- (no assignment)	



# OUTPUTS

Pressing OUTPUTS shows this screen:

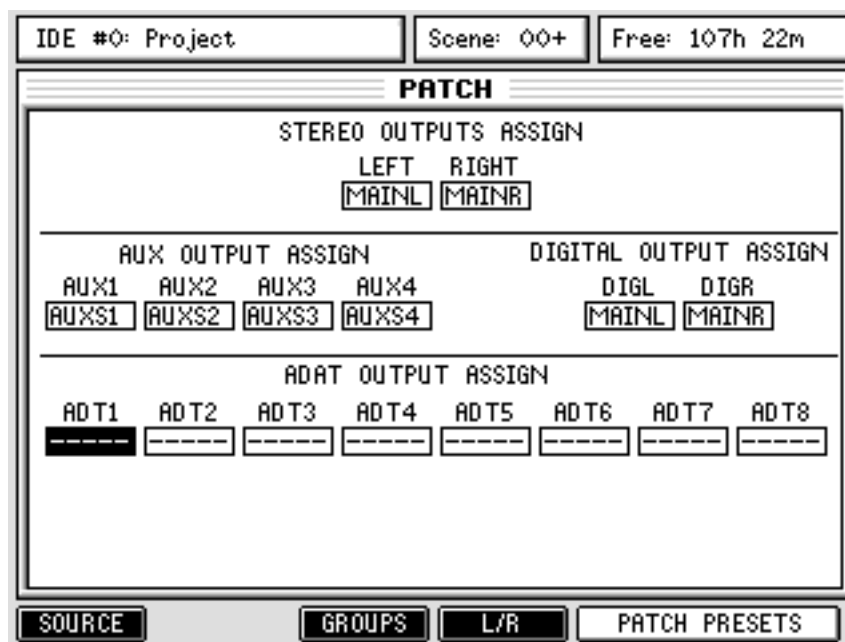

Here, you can patch internal audio sources to any of the DPS24's outputs. Basically, in this page, any audio source within the DPS24 can be assigned to any of the physical output connectors on the rear panel. The available audio sources are:

INPUTS 1-12	SOLO L	FX1 L	(FX 1 output L)
TRACKS 1-24	SOLO R	FX1 R	(FX 1 output R)
ADC 1-12	FX SEND BUS 1	FX2 L	(FX 2 output L)
DIGI L	FX SEND BUS 2	FX2 R	(FX 2 output R)
DIGI R	FX SEND BUS 3	FX3 L	(FX 3 output L)
AUX IN L	FX SEND BUS 4	FX3 R	(FX 3 output R)
AUX IN R	AUX SEND BUS 1	FX4 L	(FX 4 output L)
2-TRACK IN L	AUX SEND BUS 2	FX4 R	(FX 4 output R)
2-TRACK IN R	AUX SEND BUS 3	-----	(no assignment)
ADAT 1-8	AUX SEND BUS 4		
ADAT 9-24 (*)			
GROUPS 1-8			
MAIN L - default			
MAIN R - default			

\* with IB-24ADT option board installed

STEREO OUTPUTS ASSIGN allows you set which of the above audio sources will appear at the STEREO outputs (the default, of course, is ST L and ST R - stereo bus left and right).

AUX OUTPUT ASSIGN allows you to set which of the above audio sources is sent to the four aux send outputs (the default is AUX 1-4).

DIGITAL OUTPUT ASSIGN allows you set which of the above audio sources will appear at the STEREO outputs (the default, of course, is ST L and ST R - stereo bus left and right).

ADAT OUTPUT ASSIGN allow you to set which of the above audio is sent to the optical digital output. The default is no assignment (-----)

If the IB-24ADT option board is installed, the additional ADAT outputs 9-24 will be available.

## GROUPS

Pressing GROUPS shows this screen:

IDE #0: Project		Scene: 00+		Free: 107h 22m			
PATCH							
INPUT CHANNEL GROUP ASSIGN							
1	2	3	4	5	6		
GR1/2	GR1/2	GR3/4	GR3/4	GR5/6	GR5/6		
7	8	9	10	11	12		
GR7/8	GR7/8	GR1/2	GR1/2	GR3/4	GR3/4		
DISK RECORD GROUP ASSIGN							
1	2	3	4	5	6	7	8
-----	-----	-----	-----	-----	-----	-----	-----
9	10	11	12	13	14	15	16
-----	-----	-----	-----	-----	-----	-----	-----
17	18	19	20	21	22	23	24
-----	-----	-----	-----	-----	-----	-----	-----
FX RTN GROUP ASSIGN							
	FX1	FX2	FX3	FX4			
	-----	-----	-----	-----			
OUTPUTS		SOURCE		L/R		PATCH PRESETS	

INPUT CHANNEL GROUP ASSIGN allows you to decide which groups the input channels will be assigned to and any channel may be assigned to any group 1-8. Note, however, that routing is done in pairs.

**NOTE:** Although it is perfectly feasible to route channels to groups in this page, you may find it easier to use the front panel keys - i.e. press the appropriate GROUP ASSIGN key and then press the channels you want to assign to that group).

DISK RECORD GROUP ASSIGN allows you to select which groups the 24 disk tracks will be routed to and any track may be assigned to inputs 1-8. As with the input channels, that routing is done in pairs. Regarding the NOTE above, you may find it easier to assign disk tracks to groups in the same way.

FX RTN GROUP ASSIGN allows you to select which groups the internal effects returns will be routed to. Regarding the NOTE above, you may find it easier to assign disk tracks to groups in the same way.

**NOTE:** You can only route any channel to one group at a time. For example, you cannot route Input 1 to Group 1/2 and Group 3/4.

## L/R

Pressing L/R shows this screen:

IDE #0: Project				Scene: 00+		Free: 107h 22m	
PATCH							
INPUT CHANNEL L/R ASSIGN							
1	2	3	4	5	6		
---	---	---	---	---	---		
7	8	9	10	11	12		
---	---	---	---	---	---		
DISK TRACKS L/R ASSIGN							
1	2	3	4	5	6	7	8
L/R	L/R	L/R	L/R	L/R	L/R	L/R	L/R
9	10	11	12	13	14	15	16
L/R	L/R	L/R	L/R	L/R	L/R	L/R	L/R
17	18	19	20	21	22	23	24
L/R	L/R	L/R	L/R	L/R	L/R	L/R	L/R
FX RTN L/R ASSIGN				GROUP L/R ASSIGN			
FX1	FX2	FX3	FX4	GR1/2	GR3/4	GR5/6	GR7/8
L/R	L/R	L/R	L/R	---	---	---	---
OUTPUTS		SOURCE		GROUPS		PATCH PRESETS	

This page allows you to route channels to the L/R bus (and hence the master STEREO output). All channels (inputs, disk tracks, FX return and group outputs) can be assigned to the L/R bus. The options here are simple - off ( - - - ) or L/R.

As with the group assignments, you may find it easier to route channels to the L/R bus using the control surfaces dedicated keys.

## PATCH PRESETS

PATCH PRESETS [F5/6] provide access to patch presets and pressing it shows this pop-up:

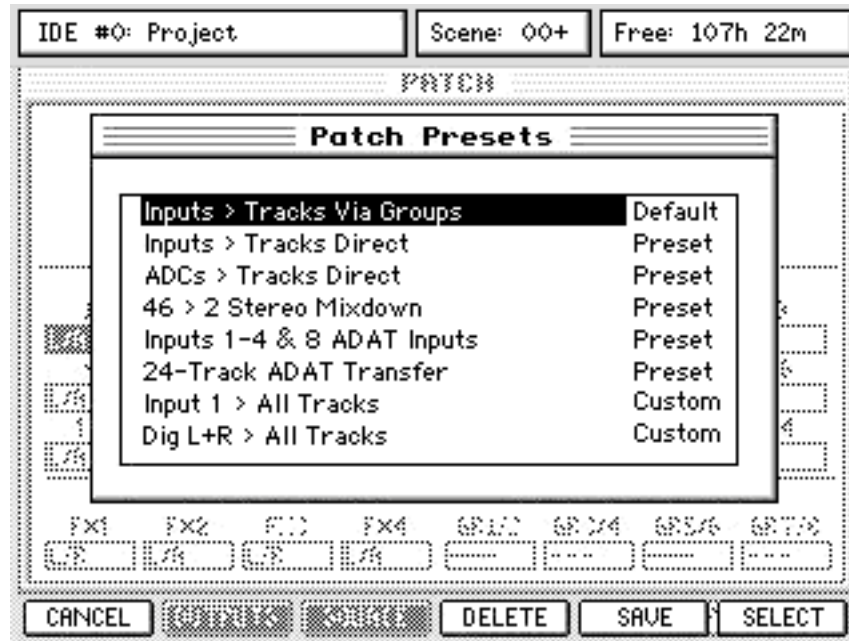

Using the cursor keys or Q6, you can move up and down the list of available presets and, using the SELECT key [F6], totally re configure the DPS24's internal patching. In this way, you can have presets suitable for track laying and overdubbing, presets for mix down and so on.

For example, "Inputs > Tracks Via Groups" - the default - allows track laying via the groups. To route any input(s) to track(s), they go via the groups and the signal is monitored via the disk tracks. Therefore, using the GROUP ASSIGN keys, you can quickly route any input to any track. This also has the advantage that several inputs can be sub-mixed to recording tracks.

This method is also used for bouncing tracks and effect internally.

You can also select the "Inputs > Tracks Direct" preset where an analog input goes to a disk track through the Input mixer Channel. The advantage of this is that it is easy to record Input 1 to Track 1, Input 2 to Track 2, etc., and you can still process the incoming signal using the Inout Mixer Channel processing (EQ, Dynamics).

You may prefer a more direct approach in "ADCs > Tracks Direct" where an analog input goes directly to a disk track, without going through the Input mixer Channel.

However, in both cases, if you want to, for example, record Input 3 to, say, Track 12 - this would require you either physically un-plug Input 3 and plug it into Input 12 or would require you to re-patch Input 3 to Track 12 in the patch page.

"24Tk > 2 Stereo Mixdown" routes all 24 tracks (and the FX returns) to the L/R mix bus for stereo mixdown whilst "46 > 2 Stereo Mixdown" routes all mixer channels (including the inputs) to the L/R mix bus so that you can mix all 24 tracks AND external instruments.

If the presets don't fit your needs exactly, it is possible to save your own configurations. Pressing SAVE [F5] pops up a prompt which allows you to name your preset. Once saved, that preset can be used at any time you want.

You can also delete existing presets if you want using the DELETE key [F4]. This will pop-up a prompt asking you to confirm the action.

# AUTOMATION

Pressing AUTOMATION shows this screen:

IDE #0: Project	Scene: 00+	Free: 107h 22m
<b>AUTOMATION SETUP</b>		
RECORD SAFE		
INPUTS		
<input checked="" type="checkbox"/>	<input type="checkbox"/>	<input type="checkbox"/>
1	2	3
<input type="checkbox"/>	<input type="checkbox"/>	<input type="checkbox"/>
4	5	6
<input type="checkbox"/>	<input type="checkbox"/>	<input type="checkbox"/>
7	8	9
<input type="checkbox"/>	<input type="checkbox"/>	<input type="checkbox"/>
10	11	12
DISK TRACKS		
<input type="checkbox"/>	<input type="checkbox"/>	<input type="checkbox"/>
1	2	3
<input type="checkbox"/>	<input type="checkbox"/>	<input type="checkbox"/>
4	5	6
<input type="checkbox"/>	<input type="checkbox"/>	<input type="checkbox"/>
7	8	9
<input type="checkbox"/>	<input type="checkbox"/>	<input type="checkbox"/>
10	11	12
<input type="checkbox"/>	<input type="checkbox"/>	<input type="checkbox"/>
13	14	15
<input type="checkbox"/>	<input type="checkbox"/>	<input type="checkbox"/>
16	17	18
<input type="checkbox"/>	<input type="checkbox"/>	<input type="checkbox"/>
19	20	21
<input type="checkbox"/>	<input type="checkbox"/>	<input type="checkbox"/>
22	23	24
GROUPS		FX RTN
<input type="checkbox"/>	<input type="checkbox"/>	<input type="checkbox"/>
1	2	3
<input type="checkbox"/>	<input type="checkbox"/>	<input type="checkbox"/>
4	5	6
<input type="checkbox"/>	<input type="checkbox"/>	<input type="checkbox"/>
7	8	1
<input type="checkbox"/>	<input type="checkbox"/>	2
9	10	3
<input type="checkbox"/>	<input type="checkbox"/>	4
Use CURSOR keys and DATA +/-		
<b>MORE</b>	<b>CLEAR</b>	<b>EVENTS</b>
<b>TRIM FADERS</b>		

Down the right are the various automation parameters that can be set. They are:

## RECORD EVENTS

Allows you to choose which events will be recorded. The options are:

- |             |  |
|-------------|--|
| ALL         | All controls will be recorded                        |
| FX/AUX SEND | Only FX/AUX send control movements will be recorded. |

**NOTE:** Even though this parameter is labelled 'FX/AUX SEND, in the case where one or other (or both) of the FX/AUX sends are configured as 'stereo' sends, the 'pan' movement of FX/AUX2 and FX/AUX4 is recorded in the automation.

- |            |  |
|------------|--|
| CHANNEL ON | Only CHANNEL ON switching will be recorded.  |
| PAN        | Only pan control movements will be recorded. |
| FADER      | Only fader movements will be recorded.       |

The default is for ALL events to be recorded but this may not be appropriate in some circumstances. For example, you may want to record a pass of CHANNEL ON switching - to reduce the risk of accidentally catching a fader and moving it, you could set the RECORD EVENTS to CHANNEL ON so that only this switching will be recorded.

## RECORD MODE

This allows you to select from three automation record modes:

- |           |   |
|-----------|---|
| OFF       | Automation data will not be recorded.   |
| AUTO DROP | Because of the faders' touch sensitivity, faders will be dropped into record as soon as they are touched (they do not have to be moved)             |
|           | Other controls will be recorded into the automation data as soon as they are moved. CHANNEL ON status will be recorded as soon as a key is pressed. |

**NOTE:** Of course, the above depends on the setting of the *RECORD EVENTS* parameter. If, for example, *RECORD EVENTS* is set to *PAN*, only *PAN* control movements will be recorded if any *PAN* controls are moved. Touch a fader, switch a channel and/or adjust the *FX/AUX* controls in this case, those movements will be ignored - only *PAN* movements will be recorded into the automation data.

This is the most useful of the three modes as you can simply grab a fader or control (or press a switch) for it to be added to the automation data.

**OVERWRITE** This is a bit more 'destructive' in that automation recording starts as soon as you press **PLAY**. To prevent accidental overwriting, when this mode of recording automation is selected, the **CHANNEL SELECT** keys flash, prompting you to select which channel(s) you wish to overwrite. Once selected, those **CHANNEL** select keys are lit steadily and as soon as you press **PLAY**, their position is recorded.

It is also possible to press **PLAY** and then press a **CHANNEL SELECT** key to drop that channel into record (much like dropping audio into record using the **TRACK SELECT** keys).

#### **DROPOUT MODE**

Allows you to select what will happen when you drop out of an automation record pass. The options are:

**STOP** The automation recording continues until **STOP** is pressed on the transport key.

In the case of **OVERWRITE** mode, recording on a given channel will stop if it is de-selected using the **CHANNEL SELECT** key(s).

**RETURN** When recording stops, the controls will return to their previously recorded position using the return time parameter (see below).

In **AUTO DROP** mode, the faders will drop out of record as soon as they are released.

**TO END** Will overwrite all events to the end of the project.

#### **RETURN TIME**

When **RETURN** is enabled (see later), this sets the time it takes for controls to return to their original value.

#### **FADER MOTORS**

Allows you to switch the fader motors on or off. Typically, you might switch the motors off once you have recorded your automation data.

The automation will playback but you won't have the distraction of the faders moving up and down.

**AUTOMATION** This switches automation **ON** or **OFF**.

**NOTE:** *AUTOMATION* must be switched **ON** not only to playback automation but also to record automation.

## ABOUT THE AUTOMATION

To record automation data, the automation must be enabled so set AUTOMATION to ON. Also, use Q2 to select AUTO DROP or OVERWRITE record modes.

With OVERWRITE, it is necessary to select the channel(s) you wish to record automation data on. When you select OVERWRITE, the CHANNEL SELECT keys flash (much like the track RECORD SELECT keys flash) - select the channel(s) for which you wish to record automation passes. As soon as you press PLAY, the DPS24 will start recording automation on the selected channel(s) and when you press STOP, recording stops. As a safety feature, the track(s) selected for automation recording are automatically de-selected when you press STOP.

You may also use OVERWRITE to drop-in to automation record. In this case, don't select any channels and press PLAY - at the required moment, press a CHANNEL SELECT key to drop that channel into automation record.

The OVERWRITE mode is also a useful way of 'erasing' automation events. For example, you may have dropped in a channel mute that you now want to erase. Select OVERWRITE, select the channel you want to overwrite and, ensuring that the channel is ON, press play and play over the point you muted it. Press STOP. Now when you playback over that area, the channel will remain on (and the mute will effectively have been erased).

The AUTO DROP selection is probably the easiest mode to use. Because of the touch sensitive faders, when AUTO DROP is selected, automation recording only starts when you grab a fader. Similarly, the other controls (pan and FX/Aux sends) only become active when moved.

To record in AUTO DROP mode, select AUTO DROP using Q2, locate to the position where you want automation to begin and press PLAY on the main transport section of the DPS24. Nothing will be recorded until you move a fader or, if they are enabled, a pan control or FX/Aux send. If you are happy with the result, rewind and continue recording fader and control movements for other channels in the same way.

Also, if you make a mistake, using AUTO, you can grab the fader/control during automation record and overwrite the original control movement. For example, a level change going into the chorus might not be quite right. Rewind to a point just before the mistake, enable AUTO record and press PLAY. At the appropriate position, ride that fader with the correct movement. Press STOP on the transport section. Rewind and check the updated version. If you like it, keep it. If you don't, press UNDO and try again.

However, doing this kind of 'Automation drop-in' can be a potential source of problems.

For example, with this original fade data:

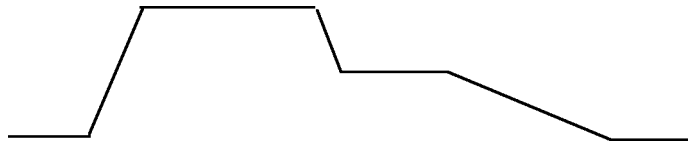

You punch-in/out some automation data as follows:

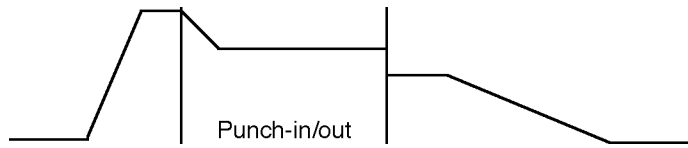

The problem here, however, is that the level at the punch-out does not match the original.

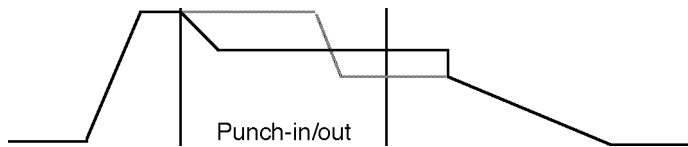

When the automation is played back, the result will be:

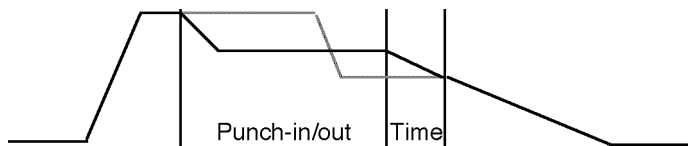

The level will stay constant after the drop-out point until a fader movement is detected at which point it will jump abruptly to the new value. A way around this is to enable RETURN. Setting a longer value in the RETURN field will result in the following:

With judicious setting of the RETURN TIME parameter, the value will 'return' gently to the original level resulting in a smoother transition.



## RECORD SAFE

The main panel shows the RECORD SAFE function. Here, you can 'protect' channels from being accidentally over-written when automation data is being recorded. Channels can be protected by moving the cursor to the appropriate channel(s) and using the DATA +/- keys to switch protection on (+) or off (-). When a channel is protected, it is 'checked' (✓):

IDE #0: Project		Scene: 00+		Free: 107h 22m	
<b>AUTOMATION SETUP</b>					
RECORD SAFE					
INPUTS					
<input checked="" type="checkbox"/>	<input checked="" type="checkbox"/>	<input checked="" type="checkbox"/>	<input checked="" type="checkbox"/>	<input type="checkbox"/>	<input type="checkbox"/>
1	2	3	4	5	6
<input type="checkbox"/>	<input type="checkbox"/>	<input type="checkbox"/>	<input type="checkbox"/>	<input type="checkbox"/>	<input type="checkbox"/>
7	8	9	10	11	12
DISK TRACKS					
<input type="checkbox"/>	<input type="checkbox"/>	<input type="checkbox"/>	<input type="checkbox"/>	<input type="checkbox"/>	<input type="checkbox"/>
1	2	3	4	5	6
<input type="checkbox"/>	<input type="checkbox"/>	<input type="checkbox"/>	<input type="checkbox"/>	<input type="checkbox"/>	<input type="checkbox"/>
7	8	9	10	11	12
<input type="checkbox"/>	<input type="checkbox"/>	<input type="checkbox"/>	<input type="checkbox"/>	<input type="checkbox"/>	<input type="checkbox"/>
13	14	15	16	17	18
<input type="checkbox"/>	<input type="checkbox"/>	<input type="checkbox"/>	<input type="checkbox"/>	<input type="checkbox"/>	<input type="checkbox"/>
19	20	21	22	23	24
GROUPS			FX RTN		
<input type="checkbox"/>	<input type="checkbox"/>	<input type="checkbox"/>	<input type="checkbox"/>	<input type="checkbox"/>	<input type="checkbox"/>
1	2	3	4	5	6
<input type="checkbox"/>	<input type="checkbox"/>	<input type="checkbox"/>	<input type="checkbox"/>	<input type="checkbox"/>	<input type="checkbox"/>
7	8	1	2	3	4
Use CURSOR keys and DATA +/-					
MORE		CLEAR		EVENTS	
TRIM FADERS					

When a channel is 'safe', any control movement or switch action is ignored when automation is being recorded.

The MORE [F1] key allows you to access the Record Safe controls for the other Channels:

IDE #0: Project		Scene: 00+		Free: 107h 22m	
<b>AUTOMATION SETUP</b>					
RECORD SAFE					
MASTER			AUX IN		
<input checked="" type="checkbox"/>			<input type="checkbox"/>		
FX SENDS			AUX SENDS		
<input type="checkbox"/>	<input type="checkbox"/>	<input type="checkbox"/>	<input type="checkbox"/>	<input type="checkbox"/>	<input type="checkbox"/>
1	2	3	4	1	2
<input type="checkbox"/>	<input type="checkbox"/>	<input type="checkbox"/>	<input type="checkbox"/>	<input type="checkbox"/>	<input type="checkbox"/>
3	4	5	6	3	4
MIDI CONTROLLERS					
<input type="checkbox"/>	<input type="checkbox"/>	<input type="checkbox"/>	<input type="checkbox"/>	<input type="checkbox"/>	<input type="checkbox"/>
1	2	3	4	5	6
<input type="checkbox"/>	<input type="checkbox"/>	<input type="checkbox"/>	<input type="checkbox"/>	<input type="checkbox"/>	<input type="checkbox"/>
7	8	9	10	11	12
<input type="checkbox"/>	<input type="checkbox"/>	<input type="checkbox"/>	<input type="checkbox"/>	<input type="checkbox"/>	<input type="checkbox"/>
13	14	15	16		
Use CURSOR keys and DATA +/-					
MORE		CLEAR		EVENTS	
TRIM FADERS					

## TRIM FADERS

Another way to edit automation data is to use TRIM FADERS. This allows you to add or subtract values to previously recorded automation data. For example, you may have recorded a perfect set of fader movements only to find the whole thing needs to be 3dB higher. Rather than re-record the whole thing again, you can use TRIM to add 3dB to that channel.

Pressing TRIM FADERS [F5/F6] snaps all the faders to midway position, switches the fader motors off and shows the following screen:

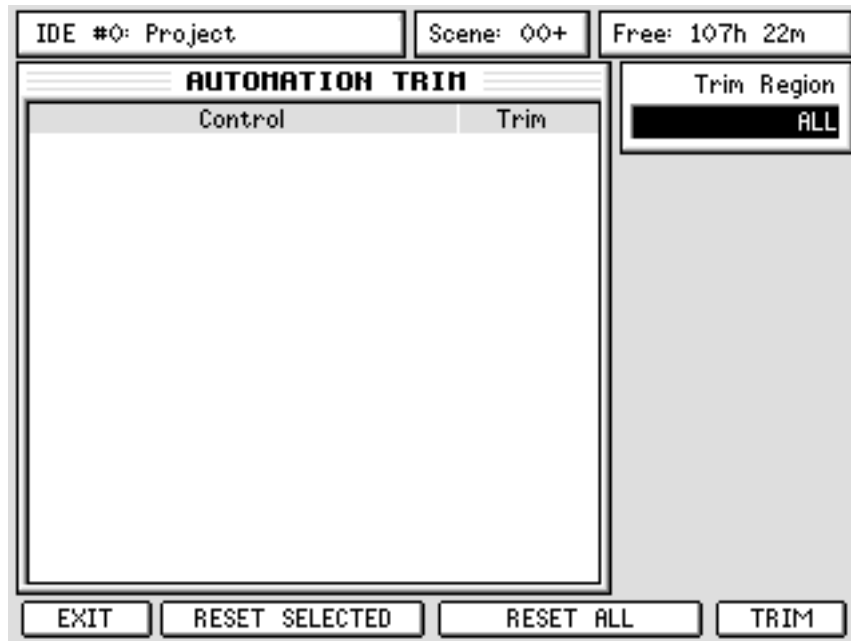

Initially, the AUTOMATION TRIM window is blank - you can adjust the fader positions at this point. Simply move a fader (or faders) and they will be shown in the AUTOMATION TRIM window:

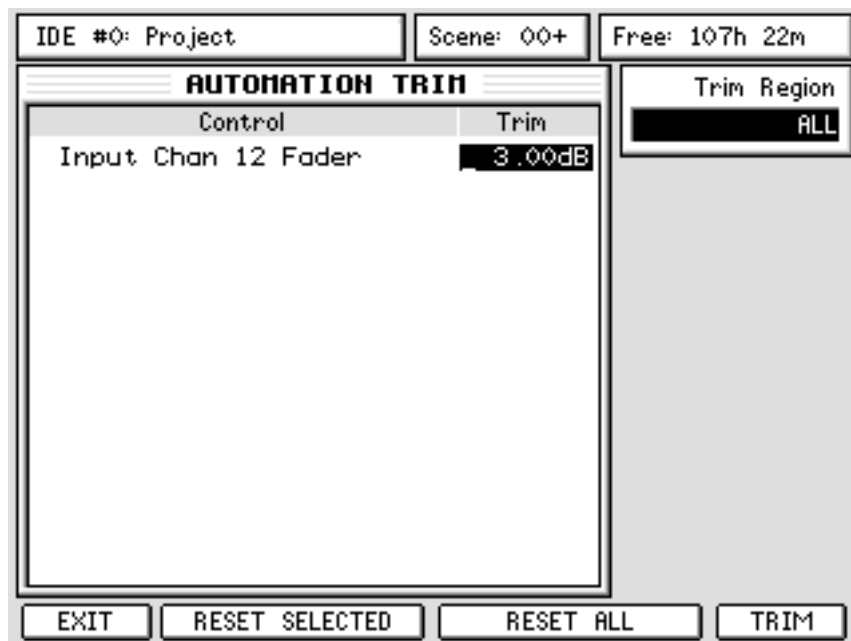

The window shows the fader(s) selected for trimming. In the event of a mistake (or if you change your mind) you can reset all the channels using RESET ALL (F3/4) or you can use the CURSOR UP/DOWN keys or Q6 to select a particular fader and reset just that one using RESET SELECTED (F2/3).

Pressing TRIM will add or subtract the value shown in the TRIM column - in the example shown on the previous page, 3dB will be added overall to the automation data on Input Channel 12.

You can also be more selective about the region you want to trim. It might be that because of changes made to the mix, an entire channel needs to be boosted/reduced using TRIM. In this case, use Q1 to select ALL this will affect the selected channel(s) for the duration of the project.

However, it could be that only a small section of the project needs to be trimmed. In this case, identify the region you wish to trim and set IN/OUT points for that region and use Q1 to select IN<>OUT - only automation data within that region will be affected.

**NOTE 1:** *The TRIM functions only apply to fader movements - it is not possible to trim pan and/or FX/Aux automation data.*

**NOTE 2:** *The TRIM operation does not have to be a 'static' automation edit process performed in isolation - the function is available during playback allowing you to 'ride' fader levels within the context of the overall mix to add or subtract the required amount of level. When you are happy with the adjusted level(s), press TRIM to commit the adjustment.*

The IN<>OUT Trim Region setting is also useful to offset the level of a track between specific times. For instance, if you want to boost on a single snare hit on a drum track, set the IN and OUT points around the snare hit, go to the TRIM FADER mode, adjust the fader for the drum track, say by 3dB, set Trim Region to IN<>OUT and press TRIM [F6].

## CLEAR AUTOMATION

It is possible to clear dynamic automation on all or selected disk tracks.

Pressing the CLEAR [F3] function key shows this screen:

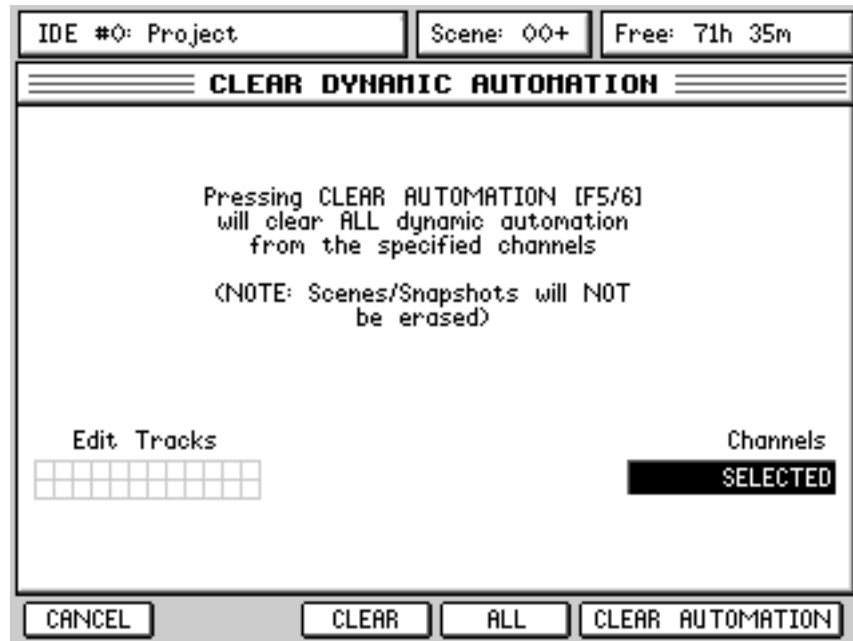

Select the tracks using the EDIT SELECT keys. Alternatively, press ALL [F4] to select all disk tracks, or select ALL in the Channels [Q5] field to select all channels (i.e. all inputs, all tracks, FX returns, etc.). Pressing F5/6 will clear the automation on the selected channels.

**NOTE 1:** Only the dynamic automation is cleared - scenes are not affected.

**NOTE 2:** In the event of making a mistake and inadvertently clearing some tracks' automation data, don't forget that you can use UNDO to get it back.

## AUTOMATED SCENE AND SNAPSHOT RECALL

In addition to dynamic automation, it is also possible to automate scene and snapshot recalls - that is, as the dynamic automation is running, scenes and snapshots can be recalled at any time as part of the automation. Snapshots can be used to change EQ or Dynamics settings of a specific channel or to change effects, at the specified time. Scenes can be used to change the entire mixer status, or to jump quickly from one mix to another, for instance between two different songs in the same project. There are many possibilities.

Of course, before you have any scenes or snapshot to recall, you must first store some scenes and snapshots with the Project. To store a scene or snapshot for subsequent recall, press SCENE STORE and follow the instructions as described earlier in this manual.

To insert a Scene or Snapshot Recall into the automation, ensuring that the Automation is switched ON and that Record Mode is set to either AUTO DROP or OVERWRITE, as the track is playing, press SCENE RECALL, select the Scene or Snapshot, followed by EXECUTE (or RECALL - F6) at the appropriate moment.

Please note that it is the point that the press EXECUTE/RECALL that is stored NOT the point at which you press SCENE RECALL. In this way, you can press SCENE RECALL in advance, select the scene or snapshot you want to insert and then, at the appropriate moment, press EXECUTE/RECALL.

When recalling a scene, you can also decide what will be recalled. (e.g. ALL controls, STATIC controls or NO FADERS) , as described earlier in this manual.

**NOTE 1:** While a Snapshot Recall is immediate, a Scene Recall can take a second or so to be 'registered' in the dynamic mix automation. That is, at the point you press EXECUTE/RECALL, it may take a second or so before the new mix settings take effect. In other words, try to insert a scene recall a little in advance of where you actually want it to occur.

If a Scene or Snapshot Recall is not placed where you want it, you can use the EVENT EDITOR (described later) to move it to exactly where you want it .

**NOTE 2:** Remember that the Scene/Snapshot Store and Recall pages are context-sensitive. Depending on which page is active when you press the SCENE STORE/RECALL keys, the DPS24 will display either the SCENE STORE/RECALL or SNAPSHOT STORE/RECALL window, i.e.

if you are in CHANNEL/EQ page, the EQ Snapshot window will pop-up,

if you are in CHANNEL/COMP or N.GATE page, the DYNAMICS Snapshot window will pop-up,

if you are in an FXpage, the FX Snapshot window will pop-up,

otherwise, the Scene window will pop-up.

However, once in the Scene/Snapshot Store or Recall page, you can switch between SCENE and SNAPSHOT mode and between Snapshot Types manually using the SCENE/SNAPSHOT button (F2) and Q5 knob respectively.

## USING AUTOMATED SCENE/SNAPSHOT RECALL

Here are just a few things you can use automated scene/snapshot recall for:

- **Static EQ changes** - change the settings of a channel's EQ using EQ Snapshot Recall at specific points in your project. This is particularly useful if you have to have two different instruments on one track. For example, on Track 5, you may have electric piano during the verses and strings during the chorus and each need specific EQ settings. Store the EQ settings for each instrument in two different snapshots and recall them as appropriate.
- **FX changes** - change the selection of effects using FX Snapshot Recall at specific points in your project. Using the above example of electric piano and strings sharing one track, the piano may require a chorus effect and the strings a reverb effect. Store the different effects selection for each instrument in two different snapshots and recall them as appropriate.
- **FX settings** - change the setting of effects parameters at specific points. For example, during the chorus, you may want an instrument to have a delay time of 1,200ms but, in the chorus, you may want this to be half of that. Store one FX snapshot with the effect at 1,200ms and another with the effect at 600ms and recall them as appropriate.
- **Static changes of multiple controls** such as pan and FX sends. Again, using the above example of electric piano sharing a single track, you may want the piano panned to the left with a hint of chorus and the strings panned to the right with a wash of reverb. Set each one as appropriate, store the settings for each in two different scenes and recall them as appropriate.
- **Completely re-configure your mix** by recalling static fader settings. Although it is more likely you will use gradually evolving, dynamic mixing, it can still be very useful to completely re-configure your fader settings with a simple scene recall (especially in live applications where it is common to re-configure a mix).
- **Mute grouping** - sometimes it might be necessary to mute several channels at once. Although this can be achieved by recording individual channel mutes in several passes, a simpler way is to mute all the channels you want to drop out and store that in a scene. At the appropriate moment, recall that scene and all those channels will be muted.

For example, you want to mute channels 1, 2, 5, 6, 10, 14, 15, 16, 17, 21, 22, 23, 24 at a particular point in the mix. As mentioned, you can record these mutes separately in several automation passes but this takes time and, more importantly, it might be difficult to synchronise those mutes. A better method would be to stop playback, mute those channels and store a scene. Then, at the appropriate moment, recall that scene as part of the dynamic mix automation - the selected channels will be muted simultaneously. Recall another scene with those channels re-enabled.

- **Static control changes of the MBCX** - change the settings of the MBCX as the dynamic content of the songs your master track changes. For example, the first song might be quite bass heavy and require a certain combination of settings whilst the next song is a little lighter in the LF region and so may require different settings. Store each one in two different scenes and switch between them as appropriate.

These are just a few suggestions. No doubt you will find your own uses for automated scene/snapshot recall according to your circumstances and application.

## NOTES REGARDING AUTOMATED SCENE RECALL

- Because scene recalls take a certain time to be effective, be sure to insert a scene recall a fraction in advance of where you want it to occur. Ideally, scene recalls should be inserted during a moment of silence on the channel(s) selected to be affected. You can use the EVENT EDITOR to move scene recalls to the optimum point.
- Because it takes the effects processor a certain time to change from one effect to another, be sure to insert a scene recall that contains an effects change a fraction in advance of where you want them to change in order to give the effects time to change. Ideally, scene recalls should be inserted during a moment of silence on the channel(s) selected to be affected.

You can use the EVENT EDITOR to move scene recalls to the optimum point.

- Because it takes a certain time for an effect to change its parameters (for example, delay time), be sure to insert a scene recall a fraction in advance of where you want the change to take place in order to give the effect time to change. Ideally, scene recalls should be inserted during a moment of silence on the channel(s) selected to be affected. You can use the EVENT EDITOR to move scene recalls to the optimum point.
- Scene 00 is still an important factor in the way automation plays back as this sets the initial scene settings for the start of all automation, regardless of what happens subsequently in the mix. Therefore, when Automation is ON, Scene 00 is always recalled first when you press PLAY, even if you have not inserted a Scene00 Recall in the Automation.

- When setting parameters, it is important to remember to store the settings you make to a scene before re-commencing playback. Imagine this scenario.....

You are adjusting the EQ on a particular channel in real-time as a project is playing. You get so far with the adjustment but the project finishes. You press stop, locate to the start of the project (or wherever) and press play and.....

The settings for the scene at the point you re-commence playback are restored and all the adjustments you have just made have been lost. In other words....

Be sure to save all settings into a scene before re-commencing playback.

If you haven't inserted any automated Scene Recall, save your static settings in Scene 00.

This is standard practice on all automated consoles and not a limitation of the DPS24.

- Think carefully about what parameters will be stored in a SCENE STORE and, more importantly, what parameters will be recalled with a SCENE RECALL as a mistake could affect the dynamic mix automation. As an example.....

As a result of the dynamic mix automation, the faders for channels 1-4 may have gradually faded down to -40dB. However, you recall a scene where the faders are at +2dB. The result is that at the point of the automated scene recall, the faders for channels 1-4 will suddenly shoot from -40dB to +2dB. Please take care when storing scenes (or more importantly, please take care when recalling scenes) that the correct parameters are recalled so as not to upset a carefully performed dynamic automation pass.

If you do make a mistake, use UNDO and try again. Alternatively, use the event editor to delete the recall and try again.

**NOTE:** When storing/recalling scenes, the store/recall function will 'remember' the last selection made. This is intentional as it allows you to work a particular way (i.e. set NO FADERS and always store/recall scenes with this setting). However, if you are likely to store/recall different settings with each store/recall, please bear this in mind and ensure you make the correct selection. As mentioned, if you do make a mistake, you can use UNDO.

The chances are that in practice, you will use the dynamic automation for level control and the rest of the automation will be switching 'static' controls such as pan, FX send, EQ, etc. via scene or snapshot recalls.

If this is the case, in the AUTOMATION page, set RECORD EVENTS to FADER and in the SCENE STORE/RECALL prompt, select NO FADER.

In this way, you can use the DPS24's dynamic automation to regulate channel/track level but use SCENE RECALL to switch between certain 'static' control settings of pan, FX/Aux sends, EQ, etc.. In other words, fader automation will be unaffected as you make 'static' scene recalls of other parameters such as pan, FX/Aux sends, EQ, etc..

If your automation requirements are different and/or are more demanding (for example, you want to gradually pan one or more channels back and forth between left/right and/or you want to gradually add effects to one or more channels) , you will have to make your own choices as to how to proceed.



## AUTOMATION EVENT EDITOR

A simple automation event editor is available to edit scene recall, snapshot recall and channel mute events, so that they can be placed accurately or deleted.

Pressing EVENT [F4] in the AUTOMATION page shows something like this:

IDE #0: Project	Scene: 00+	Free: 107h 22m																																						
<b>AUTOMATION EVENTS</b>																																								
<table border="1"> <thead> <tr> <th>Type</th> <th>Value</th> <th>Time</th> </tr> </thead> <tbody> <tr> <td>Scene Rcl [A]</td> <td>#03</td> <td>00:00:12:06.6</td> </tr> <tr> <td>FX Rcl Fx1</td> <td>#00</td> <td>00:14:59:08.3</td> </tr> <tr> <td>EQ Rcl Tr1</td> <td>#00</td> <td>00:15:01:11.4</td> </tr> <tr> <td>EQ Rcl Tr2</td> <td>#01</td> <td>00:15:08:05.0</td> </tr> <tr> <td>FX Rcl Fx4</td> <td>#01</td> <td>00:15:11:15.7</td> </tr> <tr> <td>FX Rcl Fx1</td> <td>#01</td> <td>00:15:21:01.7</td> </tr> <tr> <td>DYN Rcl Tr3</td> <td>#00</td> <td>00:15:22:12.9</td> </tr> <tr> <td>DYN Rcl Tr9</td> <td>#01</td> <td>00:15:33:00.5</td> </tr> <tr> <td>Tr12 On/Off</td> <td>OFF</td> <td>00:15:44:01.9</td> </tr> <tr> <td>Tr12 On/Off</td> <td>ON</td> <td>00:15:59:08.2</td> </tr> <tr> <td>Scene Rcl [S]</td> <td>#02</td> <td>00:16:16:23.9</td> </tr> </tbody> </table>		Type	Value	Time	Scene Rcl [A]	#03	00:00:12:06.6	FX Rcl Fx1	#00	00:14:59:08.3	EQ Rcl Tr1	#00	00:15:01:11.4	EQ Rcl Tr2	#01	00:15:08:05.0	FX Rcl Fx4	#01	00:15:11:15.7	FX Rcl Fx1	#01	00:15:21:01.7	DYN Rcl Tr3	#00	00:15:22:12.9	DYN Rcl Tr9	#01	00:15:33:00.5	Tr12 On/Off	OFF	00:15:44:01.9	Tr12 On/Off	ON	00:15:59:08.2	Scene Rcl [S]	#02	00:16:16:23.9	<table border="1"> <tr> <td>Event Channel</td> </tr> <tr> <td>ALL</td> </tr> </table>	Event Channel	ALL
Type	Value	Time																																						
Scene Rcl [A]	#03	00:00:12:06.6																																						
FX Rcl Fx1	#00	00:14:59:08.3																																						
EQ Rcl Tr1	#00	00:15:01:11.4																																						
EQ Rcl Tr2	#01	00:15:08:05.0																																						
FX Rcl Fx4	#01	00:15:11:15.7																																						
FX Rcl Fx1	#01	00:15:21:01.7																																						
DYN Rcl Tr3	#00	00:15:22:12.9																																						
DYN Rcl Tr9	#01	00:15:33:00.5																																						
Tr12 On/Off	OFF	00:15:44:01.9																																						
Tr12 On/Off	ON	00:15:59:08.2																																						
Scene Rcl [S]	#02	00:16:16:23.9																																						
Event Channel																																								
ALL																																								
EXIT	MOVE EVENT	DELETE EVENT																																						

In the AUTOMATION EVENTS window, you can see any scene or snapshot recall events or channel mutes. To select what is viewed, use Q1 to select SCENE RECALL (will show scene recall events) or INPUTS 1-12, TRACKS 1-24, GROUP 1-8, FX SEND 1-4, AUX SEND 1-4, FX RETURN 1-4, AUX IN and ALL (will show channel on/off events and snapshot recall events).

**NOTE:** It is not possible to change these values and they are shown for information only.

In the case of Scene Recall, the Type column will show the type of Scene recall as follows:

Scene Rcl [A]	All controls
Scene Rcl [S]	Static controls only
Scene Rcl [NF]	No faders

The Value column shows the scene number.

In the case of Snapshot Recall, the Type column will show the type of Snapshot as follows:

EQ Rcl Tr n	or	DYN Rcl Ip n
FX Rcl Fxn		

Where 'n' is the channel number ('Tr' for Track and 'Ip' for Input)

The Value column shows the snapshot number.

In the case of channel on/off events, Type is shown as:

XYZ n on/off

Where 'XYZ' is the channel type (Inp, Trk, Grp, Fxs, Fxr) and 'n' is the channel number.

The Value column will show ON or OFF accordingly.

**NOTE:** In the case of stereo paired channels, the event editor will only show the channel on/off status in the odd numbered channel. For example, if Tracks 11 and 12 are stereo paired and a channel on/off operation is performed, the event(s) will only show when TRACK II is selected - the event(s) will not be shown in TRACK 12.

## EDITING EVENTS

Events can be deleted and/or moved.

To delete an event, simply press DELETE EVENT [F5/F6].

If you make a mistake and accidentally delete an event, you can use UNDO.

To move an event, press MOVE EVENT [F3/F4]. You will see this prompt:



You can either type in a new value or you can move the cursor to the appropriate digit and 'nudge' the value using the DATA ENTRY +/- keys.

Press MOVE to actually move the event (or CANCEL to abort).

If you make a mistake, you can use UNDO.

# EFFECTS MODE

Pressing FX shows (something like) this screen:

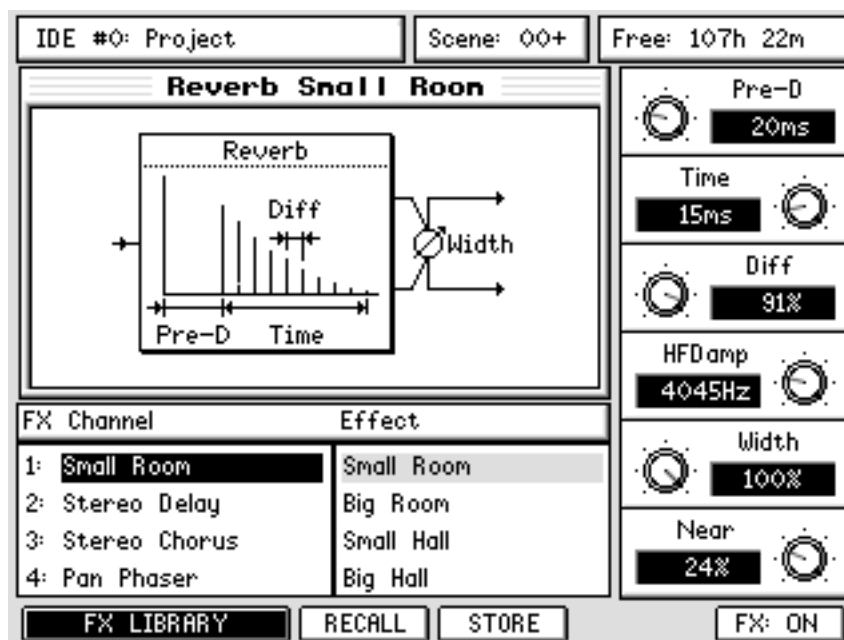

You can see the four effects channels and the effect type assigned to them.

A graphic depiction of the selected channel's effect is shown and the effect's parameters are available down the right side of the panel for editing.

Channels are selected using the CURSOR UP/DOWN keys:

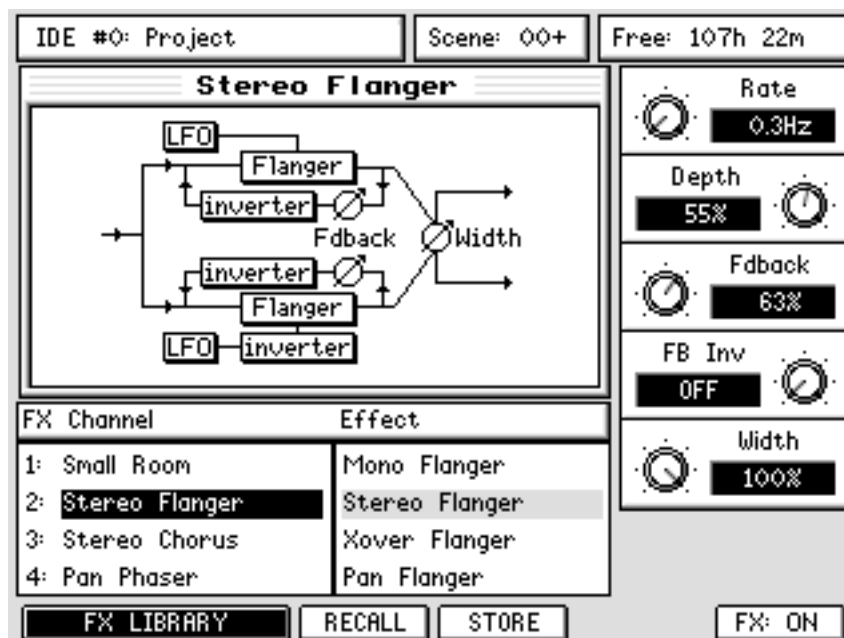

The effect assigned to the selected channel is shown in the EFFECTS list and its parameters

are available for immediate editing.

To select effect types, move the cursor to the EFFECT list using the CURSOR > key:

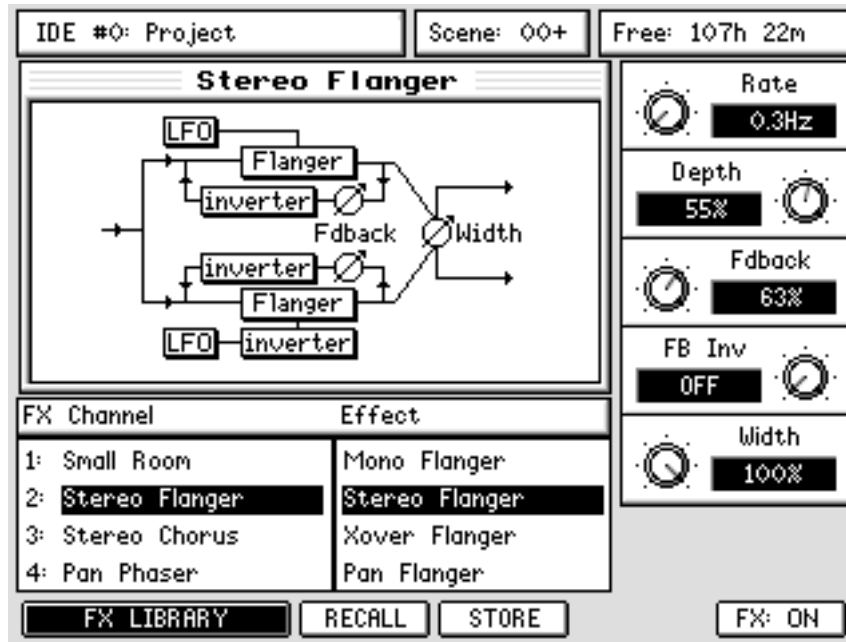

The cursor moves to the right hand column where you can select effects.

To select a different effect, use CURSOR UP/DOWN. The new effect is not active until RECALL [F3] is pressed. Pressing RECALL will assign the effect type to the selected effects channel:

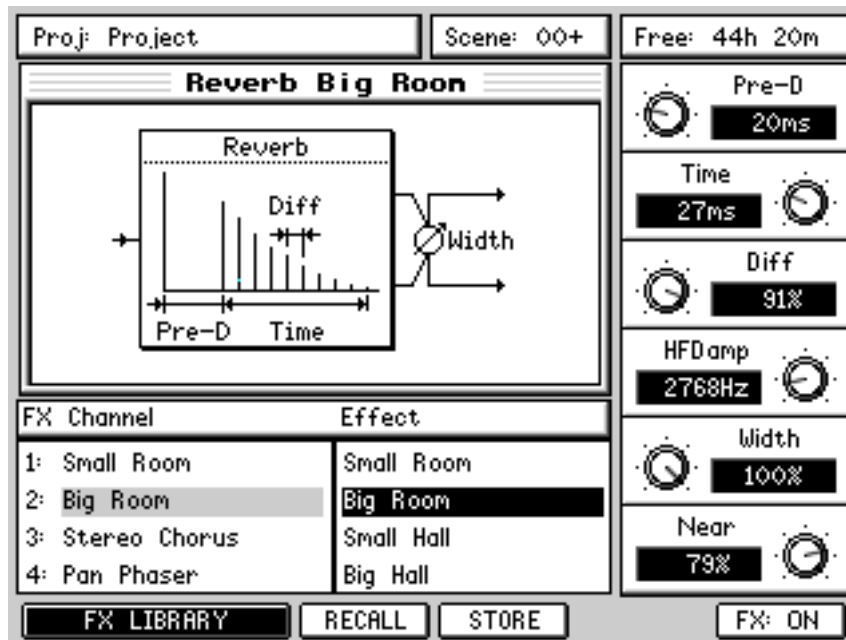

The FX Channel shows the new effect assignment and the new effect's parameters are available for editing. The effect window's title also shows the new effect assignment.

## EDITING EFFECTS

To edit an effect, no special mode is required - simply change the Q-LINK controls.

The edit remains valid for the effects channel until either another effects preset is selected or another project is loaded/created.

**NOTE:** *If you edit an effects preset but then go on to select another preset, if you re-select the effects preset you edited, its original values will be recalled, NOT your edited values. If, when editing an effect, you feel that it is worth keeping, you should save it to the FX LIBRARY (see next section).*

Effects assignments are saved with the current scene so that recalling that scene recalls the correct effect. Because scenes are recalled with the project, this ensures that the correct effects are associated with the project.

Edited effects are stored as part of the current scene so that when you subsequently load that scene, the correct effects assignment and their customised settings are recalled.

## STORING EDITED EFFECTS

If you have edited an effect that you think you may want to keep for use in other projects, press the STORE key [F4]. You will receive the usual naming prompt where you may enter a suitable name. Pressing OK [F6] will save that effect to the FX Library in the selected category.

For example, if you have edited a chorus effect - using STEREO CHORUS preset as the basis for your customised effect - when you store the effect, it will automatically be stored to the CHORUS category. Likewise, if you edit a delay effect and store it, it will automatically be added to the DELAY effects category (see the next page for details of the FX Library and effects categories).

The new effect can be used in other projects.

## EFFECTS LIBRARY

Another way to select effects is by way of the EFFECTS LIBRARY. The EFFECTS LIBRARY also allows you to store effects for recall in other projects.

To select an effect from the library, first select the channel you want to assign the effect to. Now press FX LIBRARY [F1/F2] in the main FX page. You will see this screen:

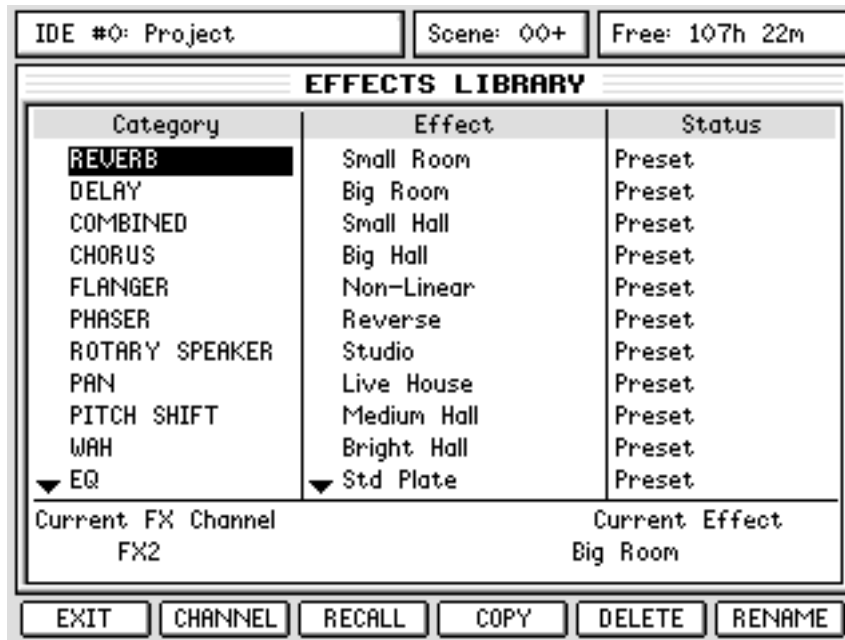

Here, you can also change the current FX Channel using the CHANNEL [F2] key.

Using the CURSOR UP/DOWN key or Q6, you can select an effects 'category' such as reverb, delay, chorus, etc.. In this way, effects are easily found and selected by category rather than scrolling through a long list of different types of effects.

To select an actual effect within a given category, you should press the CURSOR > key to move to the EFFECT list:

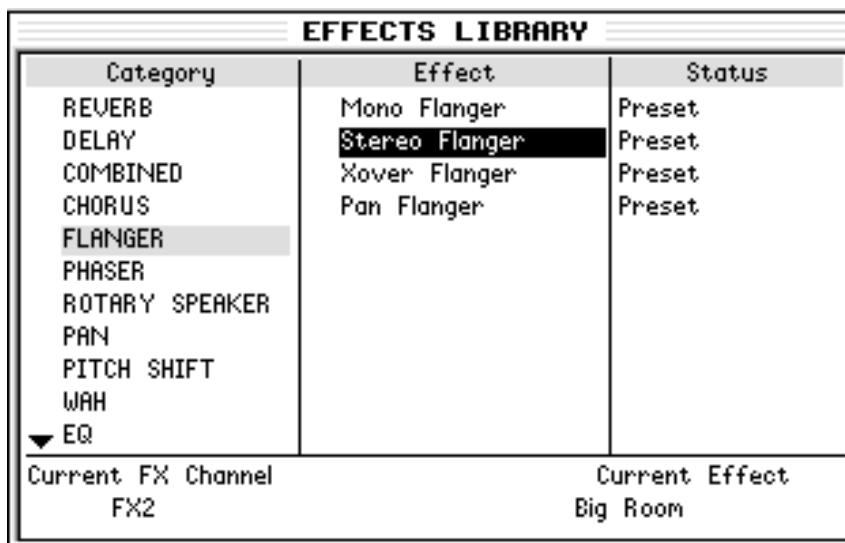

You may now select an effect and assign it to the selected FX channel using RECALL [F3].

It is possible to delete Custom effects using the DELETE key [F5]

It is possible to rename Custom effects using the RENAME key [F6]

It is possible to copy (and store) effects using the COPY key [F4]

**NOTE:** *It is not possible to delete, rename and/or copy effects categories.  
Neither is it possible to delete or rename Preset effects types.*

Pressing EXIT [F1] will return you to the main FX page. The effect assigned in the FX LIBRARY page will be shown on the selected channel.

## FX LIBRARY FACTORY PRESETS

The following Categories and Presets are available as Factory Presets

Category	Effect	Category	Effect	
<b>REVERB</b>	Small Room	<b>FLANGER</b>	Mono Flanger	
	Big Room		Stereo Flanger	
	Small Hall		Xover Flanger	
	Big Hall		Pan Flanger	
	Non-Linear	<b>PHASER</b>	Mono Phaser	
	Reverse		Stereo Phaser	
	Studio		Xover Phaser	
	Live House		Pan Phaser	
	Medium Hall	<b>ROTARY SPEAKER</b>	Rotary Speaker	
	Bright Hall			
	Std Plate			
	Std Hall			
	Drum Booth	<b>PAN</b>	Auto Pan	
	Bright Plate		Triggered Pan	
Std Room	<b>PITCH SHIFT</b>	Pitch Shift		
Vocal Plate				
<b>DELAY</b>	Mono Delay	<b>WAH</b>	Auto Wah	
	Pingpong Delay		Touch Wah	
	Panpong Delay	<b>EQ</b>	Digital EQ	
	Stereo Delay			
	Xover Delay			
	Tape Echo			
Multi Tap Delay	<b>ENHANCER</b>	Enhancer		
<b>COMBINED</b>		Chorus>Delay	<b>DISTORTION</b>	Distortion
		Flange>Delay		
	Phaser>Delay			
<b>CHORUS</b>	Mono Chorus	<b>DYNAMICS</b>	Comp/Lim	
	Stereo Chorus		Expander Gate	
	Xover Chorus		Noise Gate	
		<b>PITCH CORRECTOR</b>	Pitch Corrector	

## FX Parameters

This section describes all types and parameters of the effects included in the DPS24's internal effects.

The FX page shows a graphic representation of the currently selected effect, and the parameters for that effect can be edited using the Q-Link knobs Q1-Q6.

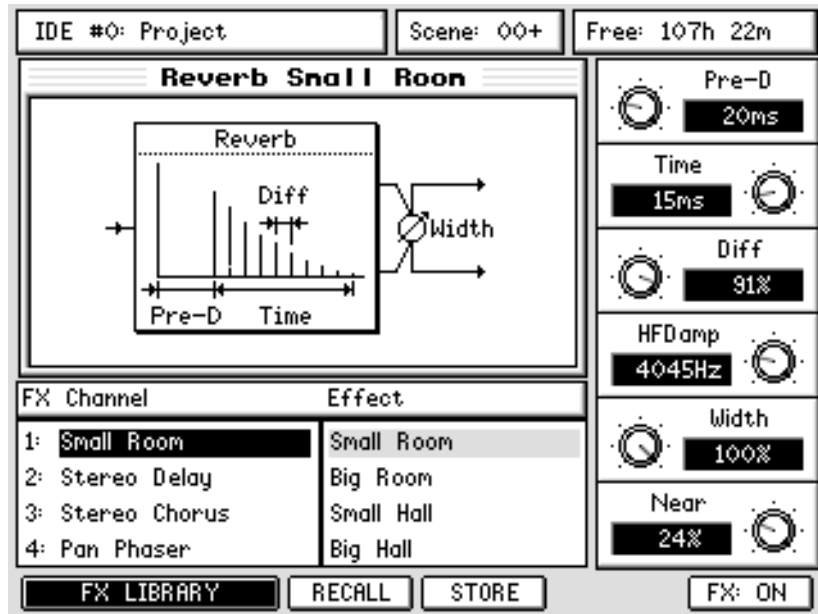

If there are more than six parameters for the selected effect, the [F5] softkey provides access to a second set of parameters for that effect:



## REVERB

Although the parameter values of the following reverb types are different, the available parameters are common to all reverb types (except Non-Linear and Reverse reverb).

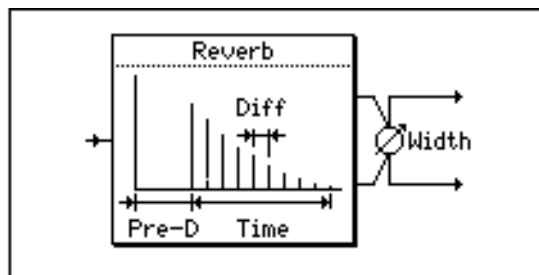

- Pre-D (1ms - 100ms) Adjusts the Pre-Delay time of early reflections.
- Time (0.1sec - 10sec) Adjusts the Time of attenuation of reverberation.
- Diff (0% - 100%) Adjusts the Diffusion (density) of reverberation.
- HFDamp (20Hz - 20kHz) Frequency at which the higher range of reverberation is cut.
- Width (0% - 100%) Adjusts the width and spread of the stereo image.
- Near (0% - 100%) Adjusts the imaginary distance to the sound source.  
The lower the value, the more depth and distance.



**REVERB>SMALL ROOM**

This stereo reverb effect simulates reverberations in a small room.

**REVERB>BIG ROOM**

This stereo reverb effect simulates reverberations in a big room.

**REVERB>SMALL HALL**

This stereo reverb effect simulates reverberations in a small hall.

**REVERB>BIG HALL**

This stereo reverb effect simulates reverberations in a big hall.

**REVERB>NON-LINEAR**

This special stereo reverb effect (gated reverb) stops reverberation at a specified time.

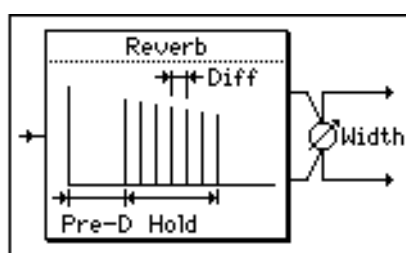

For this reverb, the Time parameter is replaced by:

- Hold (0 - 127) Adjusts the time (duration) until reverberation is stopped.

It has no HFDamp parameter.

**REVERB>REVERSE**

This special stereo reverb effect reverses the reverberations.

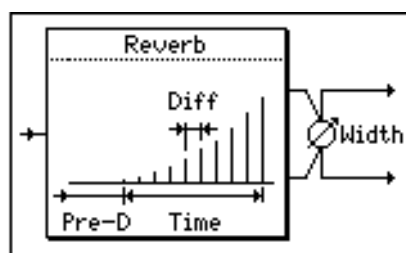

It has no HFDamp, nor Near parameter.

**REVERB>STUDIO**

This stereo reverb effect simulates reverberations in a recording studio.

**REVERB>LIVE HOUSE**

This stereo reverb effect simulates reverberations in a live house.

**REVERB>MEDIUM HALL**

This stereo reverb effect simulates reverberations in a medium-size hall.

**REVERB>BRIGHT HALL**

This stereo reverb effect simulates bright reverberations in a hall.

**REVERB>STD PLATE**

This stereo reverb effect simulates reverberations of a plate with standard character.

**REVERB>STD HALL**

This stereo reverb effect simulates reverberations in a hall with standard character.

**REVERB>DRUM BOOTH**

This stereo reverb effect simulates reverberations in a drum booth.

**REVERB>BRIGHT PLATE**

This stereo reverb effect simulates reverberations of a plate with expressive character.

**REVERB>STRING HALL**

This stereo reverb effect simulates reverberations in a hall with expressive character.

**REVERB>STD ROOM**

This stereo reverb effect simulates reverberations in a room with standard character.

**REVERB>VOCAL PLATE**

This stereo reverb effect simulates reverberations of a plate suitable for vocal sound.

**DELAY**

The basic parameters for Delay effects are:

- Delay (1ms - 1500ms) Adjusts the Delay time.
- Fdback (0% - 100%) Adjusts the amount of delay Feedback.
- HFdamp (20Hz - 20kHz) Sets the frequency at which the higher range of the feedback sound is cut.

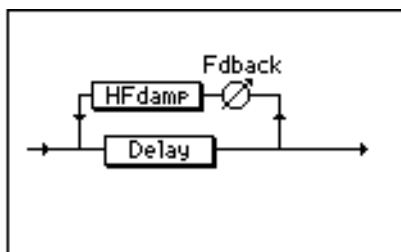

**MONO DELAY**

This is a common delay effect with mono-in and mono-out.

You can adjust the pan setting of the effect sound with the additional Pan parameter:

- Pan (-60 - +60)

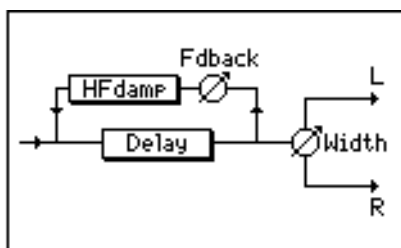

**PINGPONG DELAY**

This delay effect pans the delay sound left and right.

You can adjust the width and spread of the stereo image with the additional Width parameter:

- Width (0% - 100%)

### PANPONG DELAY

This delay effect is a variation of the PINGPONG DELAY, with a Center delay between Left and Right. An additional Mode parameter is available to set the direction of the panning effect:

- Mode : LCR ..... Left, center, then right
- RCLR ..... Right, center, then left

### STEREO DELAY

This delay effect can be set for the left and right channels individually.

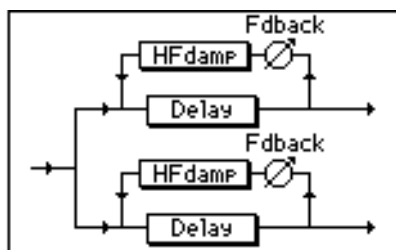

- LDelay (1ms - 1500ms) Adjusts the Delay time of the Left channel.
- Fdback (0% - 100%) Adjusts the amount of delay Feedback (Left channel).
- HFdamp (20Hz - 20kHz) Sets a frequency at which the higher range of the feedback sound (Left channel) is cut.
- RDelay (1ms - 1500ms) Adjusts the delay time of the Right channel.
- Fdback (0% - 100%) Adjust the amount of delay Feedback (Right channel).
- HFdamp (20Hz - 20kHz) Sets a frequency at which the higher range of the feedback sound (Right channel) is cut.

### XOVER DELAY

This is a variation of the STEREO DELAY. The feedback from the L/R channels is input to the opposite channels.

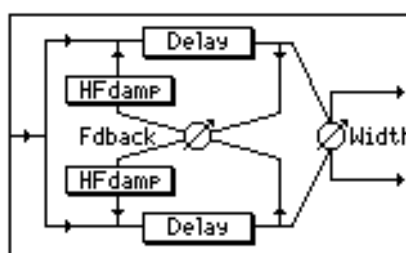

- LDelay (1ms - 1500ms) Adjusts the Delay time of the Left channel.
- Fdback (0% - 100%) Adjusts the amount of delay Feedback (Left/Right channel).
- HFdamp (20Hz - 20kHz) Sets a frequency at which the higher range of the feedback sound (Left/Right channel) is cut.
- RDelay (1ms - 1500ms) Adjusts the delay time of the Right channel.
- Width (0% - 100%) Adjusts the width and spread of the stereo image.

**TAPE ECHO**

This delay effect simulates a three-head tape echo machine. You can set three delay times individually. This effect has mono-in and mono-out; however, you can adjust the pan setting of the effect sound.

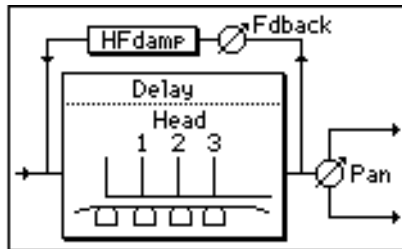

- Head 1 (1ms - 1500ms) Adjusts the Delay time of Head 1.
- Head 2 (1ms - 1500ms) Adjusts the Delay time of Head 2.
- Head 3 (1ms - 1500ms) Adjusts the Delay time of Head 3.
- Fdback (0% - 100%) Adjusts the amount of delay Feedback .
- HFdamp (20Hz - 20kHz) Sets a frequency at which the higher range of the feedback sound is cut.
- Pan (-60 - +60) Adjusts the stereo image of the effect sound.

**MULTI TAP DELAY**

This delay effect creates a special effect by adjusting the interval between feedback sounds and the level change curve of the feedback sounds.

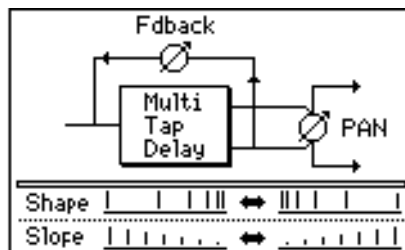

- Delay (1ms - 1500ms) Adjusts the delay time.
- Width (0% - 100%) Adjusts the width and spread of the stereo image.
- Shape (-10 - +10) Adjusts the interval between the feedback sounds.
- Slope (-10 - +10) Adjusts the attenuation curve of the feedback sound.
- Fdback (0% - 100%) Adjusts the amount of delay feedback.
- Pan (-60 - +60) Adjusts the stereo image of the effect sound.

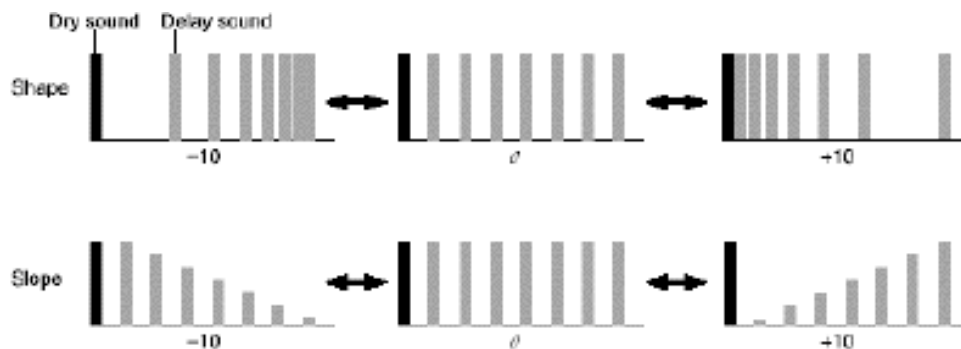

## COMBINED

Those effects combine a modulation effect (Chorus, Flanger or Phaser) and a Delay.

The parameters are :

- Rate (0.1Hz - 10.0Hz) Adjusts the speed of LFO for the modulation effect
- Depth (0% - 100%) Adjusts the depth of LFO for the modulation effect
- Fdback (0% - 100%) Adjusts the feedback amount of the modulation effect
- Delay (1ms - 1500ms) Adjusts the delay time of the delay effect
- Fdback (0% - 100%) Adjusts the amount of the delay effect feedback
- Bounce (ON/OFF) Sets whether the delay sound is panned (ON) or not

### CHORUS > DELAY

This effect consists of a chorus effect and a delay effect connected in series.

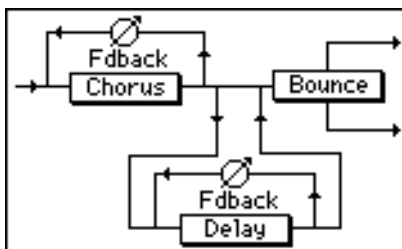

### FLANGE > DELAY

This monaural effect consists of a flanger effect and a delay effect connected in series.

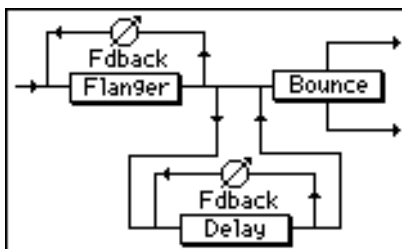

### PHASER / DELAY

This monaural effect consists of a phaser effect and a delay effect connected in series.

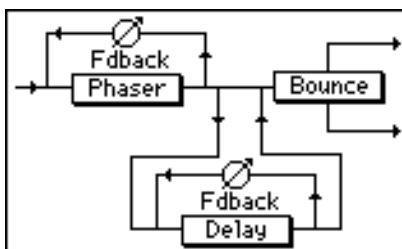

## CHORUS

The common parameters for the chorus effects are:

- Rate1 (0.1Hz - 10.0Hz) Adjusts the speed (rate) of LFO1
- Rate2 (0.1Hz - 10.0Hz) Adjusts the speed (rate) of LFO2
- Fdback (0% - 100%) Adjusts the amount of the chorus effect feedback
- Depth1 (0% - 100%) Adjusts the depth of LFO1
- Depth2 (0% - 100%) Adjusts the depth of LFO2

### MONO CHORUS

This is a typical chorus effect with mono-in and mono-out.

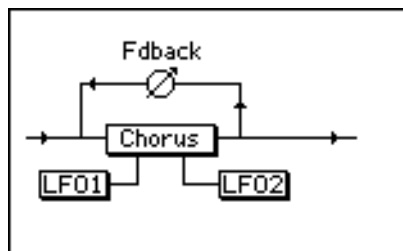

You can adjust the pan setting of the effect sound with the additional Pan parameter:

- Pan (-60 - +60)

### STEREO CHORUS

This is a stereo chorus effect (mono-in, stereo out).

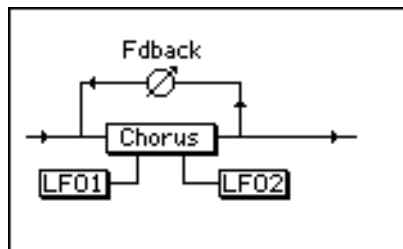

You can adjust the width and spread of the stereo image with the additional Width parameter:

- Width (0% - 100%)

### XOVER CHORUS

This is a variation of the STEREO CHORUS.

The feedback from the Left/Right channels is input to the opposite channels.

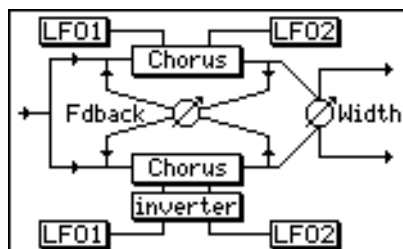

The parameters are the same.

## FLANGER

The common parameters for the Flanger effects are:

- Rate (0.1Hz - 10.0Hz) Adjusts the speed of LFO
- Depth (0% - 100%) Adjusts the depth of LFO
- Fdback (0% - 100%) Adjusts the feedback amount
- FB Inv (ON/OFF) Inverses the phase of feedback signals when enabled

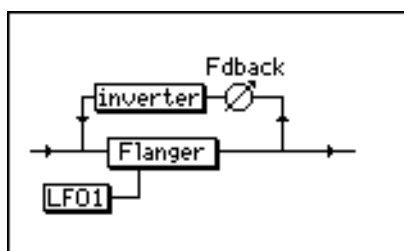

### MONO FLANGER

This is a typical flanger effect with mono-in and mono-out. You can adjust the pan setting of the effect sound with the additional Pan parameter:

- Pan (-60 - +60)

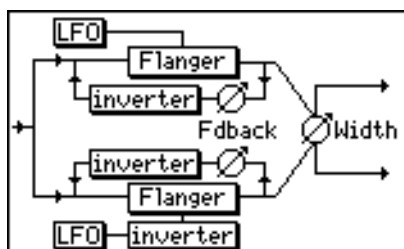

### STEREO FLANGER

This is a stereo flanger effect (mono in - stereo out). You can adjust the width and spread of the stereo image with the additional Width parameter:

- Width (0% - 100%)

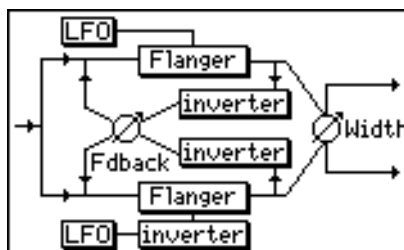

### XOVER FLANGER

This is a variation of the STEREO FLANGER. The feedback from the L/R channels is input to the opposite channels.

The parameters are the same.

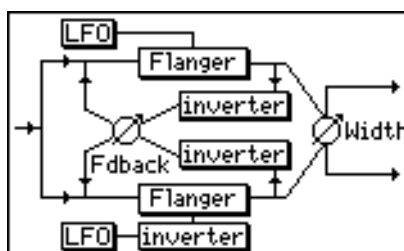

### PAN FLANGER

This effect adds an auto panning effect to the mono flanger.

## PHASER

The common parameters for the Phaser effects are:

- Rate (0.1Hz - 10.0Hz) Adjusts the speed of LFO
- Depth (0% - 100%) Adjusts the depth of LFO
- Fdback (0% - 100%) Adjusts the feedback amount

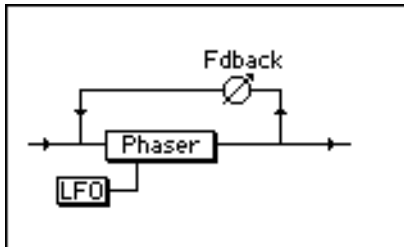

### MONO PHASER

This is a typical phaser effect with mono-in and mono-out. You can adjust the pan setting of the effect sound with the additional Pan parameter:

- Pan (-60 - +60)

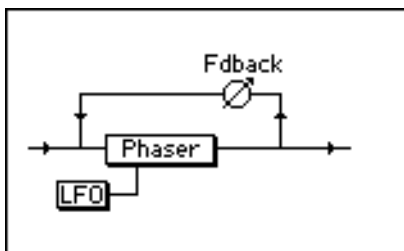

### STEREO PHASER

This is a stereo phaser effect (mono in - stereo out). You can adjust the width and spread of the stereo image with the additional Width parameter:

- Width (0% - 100%)

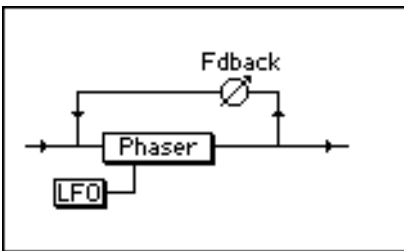

### XOVER PHASER

This is a variation of the STEREO PHASER. The feedback from the L/R channels is input to the opposite channels.

The parameters are the same.

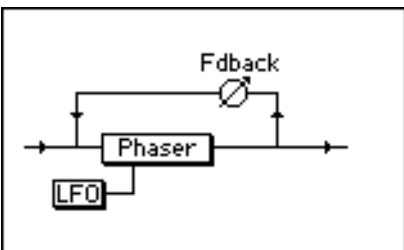

### PAN PHASER

This effect adds an auto panning effect to the mono phaser effect sound.



## ROTARY SPEAKER

### ROTARY SPEAKER

This mono-in / stereo-out effect simulates rotary speakers for organ sound.

- Rate1 (0.1Hz - 10.0Hz) Adjusts the rotation speed (Rate1) of the speakers.
- Rate2 (0.1Hz - 10.0Hz) Adjusts the rotation speed (Rate2) of the speakers.
- Accel (0.1sec - 10sec) Adjusts the time (duration) taken for switching from Rate1 to Rate 2.
- Init (R1/R2) Sets the initial rotation speed (Rate1/Rate2).

Pressing the additional [F5] TRIGGER softkey repeatedly toggles the rotation speed between Rate 1 and Rate 2.

Use the Accel parameter to adjust the time (duration) taken for switching between two speeds.

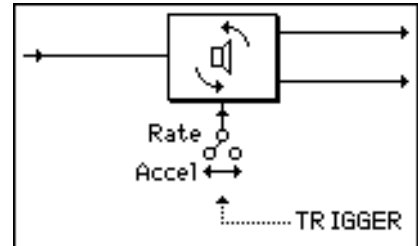

## PAN

### AUTO PAN

This auto pan effect automatically rotates the stereo image of the sound between left and right.

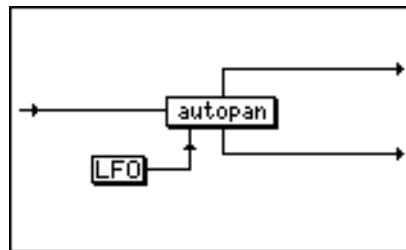

- Rate (0.1Hz - 10.0Hz) Adjusts the speed of panning.
- Mode Pan: A common auto pan.  
L>R: Simulates a sound source that rotates counterclockwise.  
R>L: Simulates a sound source that rotates clockwise.
- Width (0% - 100%) Adjusts the panning width.

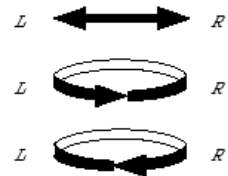

### TRIGGERED PAN

This auto pan effect becomes enabled when the output level of one of AUX sends 1 - 4 exceeds a certain level.

You can also press the [F5] (TRIGGER) softkey to start the auto pan effect manually.

- Rate (0.1Hz - 10.0Hz) Adjusts the speed of panning.
- Mode (Pan / L>R / R>L) Sets the effect of panning. (Refer to AUTO PAN.)
- Trigger AUX-1 - AUX-4 Selects which AUX signal enables the auto pan effect.  
MANUAL Pressing the [F5] key triggers the auto pan effect.
- Thresh (-60dB - 0dB) Sets the signal level at which the auto pan becomes effective.
- Width (0% - 100%) Adjusts the panning width.

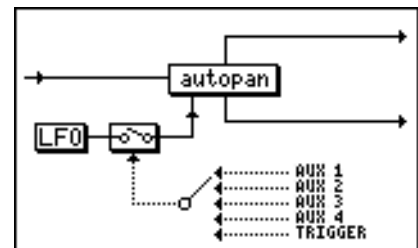

## PITCH SHIFT

This effect has a pitch shift with a range of +/- one octave, and can be set for the left channel and the right channel independently.

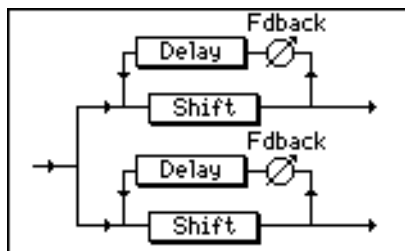

- L Semi (-12.00 - +12.00) Semitone adjustment of pitch shift for the L channel
- L Cents (-12.00 - +12.00) Cents adjustment of pitch shift for the L channel
- R Semi (-12.00 - +12.00) Semitone adjustment of pitch shift for the R channel
- R Cents (-12.00 - +12.00) Cents adjustment of pitch shift for the L channel
- Fdback L (0% - 100%) Delay feedback adjustment for the L channel
- Fdback R (0% - 100%) Delay feedback adjustment for the R channel

**Note:** The value displayed for both Semi and Cents controls is the total Pitch Shift amount.

## WAH

### AUTOWAH

This monaural effect adds a swelling wah.

- Rate (0.1Hz - 10.0Hz)  
Adjusts the speed (rate) of swelling of the wah effect
- Depth (0% - 100%)  
Adjusts the depth of the effect
- Reso (0% - 100%)  
Adjusts the amount of resonance

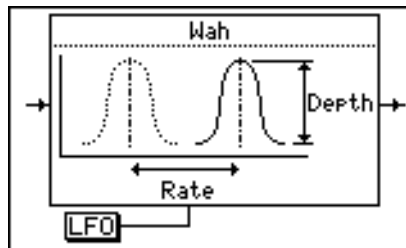

### TOUCH WAH

This monaural effect adds a wah effect to signals above a certain level.

- Thresh (-60dB - 0dB)  
Adjusts the signal level above which the wah effect becomes effective (Threshold)
- Depth (0% - 100%)  
Adjusts the depth of the effect
- Reso (0% - 100%)  
Adjusts the amount of resonance

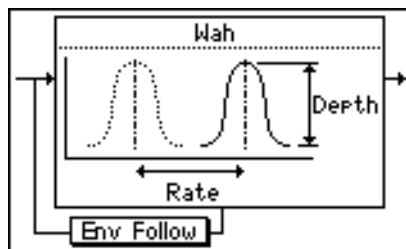

## EQ

### Digital EQ

This is a monaural, three-band parametric equalizer.

- EQ Freq 1 (20Hz - 20kHz) Sets the center frequency for EQ1
- Gain 1 (-18dB - +18dB) Adjusts the gain for EQ1
- EQ Freq 2 (20Hz - 20kHz) Sets the center frequency for EQ2
- Gain 2 (-18dB - +18dB) Adjusts the gain for EQ2
- EQ Freq 3 (20Hz - 20kHz) Sets the center frequency for EQ3
- Gain 3 (-18dB - +18dB) Adjusts the gain for EQ3

Pressing the [F5] MORE softkey accesses additional parameters:

- Q 1 (0.5 - 10) Sets the Q for EQ1
- Q 2 (0.5 - 10) Sets the Q for EQ2
- Q 3 (0.5 - 10) Sets the Q for EQ3
- Output (-24dB - +24dB)  
Offsets the output level of the EQ'ed sound

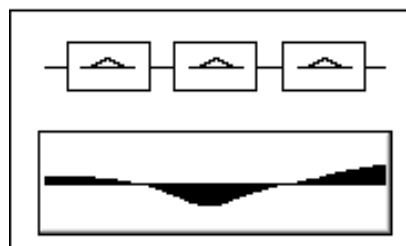

## ENHANCER

### Enhancer

This monaural effect gives frame to the sound by adding new overtones.

- Drive (0dB - 30dB) Adjusts the gain of the signal input to the harmonics generator
- Tune (0% - 100%) Adjusts the filter cut-off frequency
- Damp (0% - 100%)  
Adjusts the filter attenuation curve (slope)
- Harm (0% - 100%)  
Adjusts the signal level of the emphasized harmonics

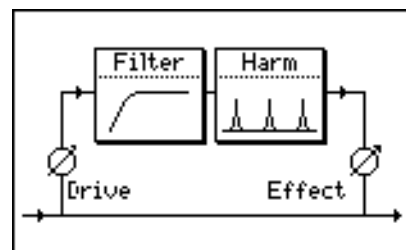

## DISTORTION

### Distortion

This monaural distortion effect distorts input signals.

An equalizer is connected to the effect in series.

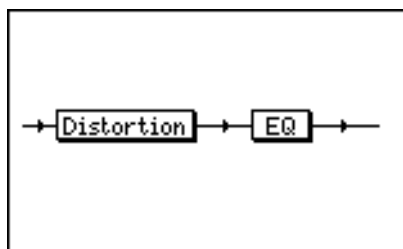

- Depth (0dB - 24dB) Adjusts the depth of distortion
- EQ freq (1000Hz - 2000Hz) Adjusts the center frequency of the EQ
- EQ Gain (-15dB - +15dB) Adjusts the gain of the EQ
- EQ (0.5 - 10) Adjusts the Q of the EQ

## DYNAMICS

**COMPRESSOR / LIMITER**

This monaural effect compresses signals above a certain level and limits the dynamic range. It also provides a noise gate that cuts noise during silence.

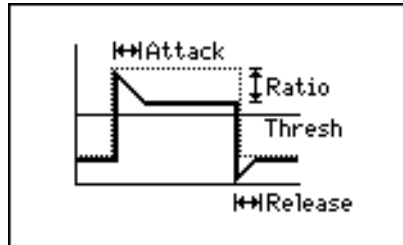

- Link (ON/OFF) Links FX1 and FX2 (or FX 3 and FX4). See details below.
- Thresh (-60dB - 0dB) Adjusts the threshold level at which the effect is enabled
- Ratio (2:1 - 100:1) Adjusts the compression ratio for signals that exceed the threshold level
- Output (-24dB - +24dB) Adjusts the output level of the effect sound
- Attack (0ms - 127ms) Adjusts the attack time of the effect
- Release (0ms - 127ms) Adjusts the release time of the effect

Pressing the [F5] (MORE) softkey provides access to another set of parameters:

- Detect : Peak ..... Changes in the signal level are closely detected  
RMS ..... Averaged level changes are detected
- Thresh (-60dB - 0dB) Adjusts the threshold level at which the noise gate opens
- Release (0ms - 127ms) Adjusts the release time of the noise gate

**Link parameter :** If you select the COMPRESSOR/LIMITER effect for both FX1 and FX2 (or FX3 and FX4) and set the Link parameter for the FX1 (or FX3) to ON, the FX2 (or FX4) parameters will use the FX1 (or FX3) parameter settings. If you did not select the COMPRESSOR/LIMITER effect for FX2 and FX4, the Link parameter setting will be ignored.

The Link parameter is useful when you wish to apply the compressor/limiter effect to a stereo signal source. (FX SEND set as 1 x STEREO in MIXER / FX/AUX SETUP)

## EXPANDER GATE

This monaural effect limits signals at a certain level (threshold) or lower and expands the dynamic range, providing an effect opposite to the compressor effect.

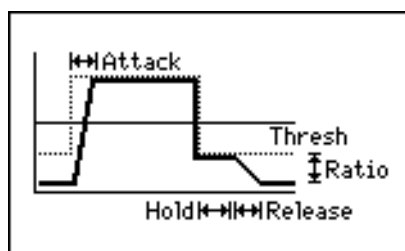

- Link (ON/OFF) Links FX1 and FX2 (or FX 3 and FX4). See previous page.
- Thresh (-60dB - 0dB) Adjusts the threshold level at which the effect is enabled
- Ratio (2:1 - 100:1) Adjusts the compression ratio for signals that are lower than the threshold level
- Output (-24dB - +24dB) Adjusts the output level of the effect sound
- Attack (0ms - 127ms) Adjusts the attack time of the effect
- Release (0ms - 127ms) Adjusts the release time of the effect

Pressing the [F5] (MORE) softkey provides access to another parameter:

- Hold (0 - 127) Adjusts the hold time of the effect

## NOISE GATE

This monaural effect mutes signals below a certain level (threshold).

This is useful for cutting noise during silent parts of a performance.

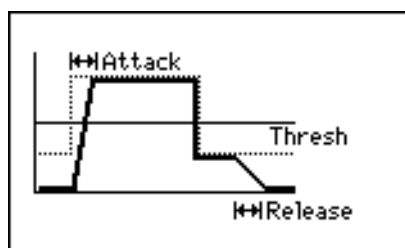

- Link (ON/OFF) Links FX1 and FX2 (or FX 3 and FX4). See previous page.
- Thresh (-60dB - 0dB) Adjusts the level at which the gate opens or closes.
- Key (AUX-1 - AUX-4) Selects the source signal that triggers the gate to open or close (AUX send 1\_4)
- Output (-24dB - +24dB) Adjusts the output level of the effect sound
- Attack (0ms - 127ms) Adjusts the attack time of the effect
- Release (0ms - 127ms) Adjusts the release time of the effect

Pressing the [F5] (MORE) softkey provides access to another parameter:

- Hold (0 - 127) Adjusts the hold time of the effect.

## PITCH CORRECTOR

### Pitch Corrector

This monaural effect corrects the pitch of monophonic input signals in real-time.

This is useful when you wish to correct the pitch of the vocal track.

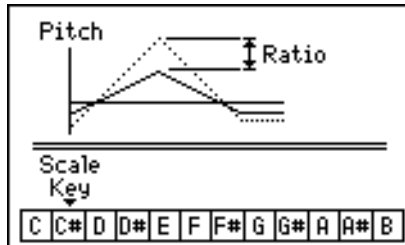

- Ratio (0% - 100%) Adjusts the amount of correction to the pitch
- Calib (415Hz - 466Hz) Sets the standard pitch
- Scale (See diagram below) Sets the standard scale
- Key (C/C#.../A#/B) Sets the standard twelve keys
- Smoothing (0% - 100%) Affects the vibrato components in the input signal to make it sound more natural. A setting of 100% takes all vibrato components away and making it smaller value makes vibrato sound more natural
- INHIBIT (ON/OFF) When this is ON, no pitch correction is applied

### Scale parameter:

You can select from the following scales for the Scale parameter.

When you change the Scale parameter, the scale display also changes as follows.

CHROMA (Chromatic scale)	C C# D D# E F F# G G# A A# B
M (Major scale)	C D E F G A B
m (Minor scale)	C D D# F G G# A#
m-HERM (Harmonic minor scale)	C D D# F G G# B
m-MELO (Melodic minor scale)	C D D# F G A B
WHOLE (Whole tone scale)	C D E G A B
BLUES (Blues scale)	C D# F F# G A#
ARAB (Arabian scale)	C C# E F G G# B
DORIAN (Dorian scale)	C D D# F G A A#
PHRYGI (Phrygian scale)	C C# D# F G G# A#
LYDIAN (Lydian scale)	C D E F# G A B
MIXOLY (Mixolydian scale)	C D E F G A A#
LOCRIA (Locrian scale)	C C# D# F F# G# A#

### User scale

When USER Scale is selected, the custom scale is defined by the ScaleBits parameter which can be accessed by pressing the [F5] MORE softkey.

The ScaleBits parameter is a numeric value calculated using a binary representation of the notes, where C is 1, C# is 2, D is 4, D# is 8, E is 16, F is 32, F# is 64, G is 128, G# is 256, A is 512, A# is 1024 and B is 2048.

For instance, using this calculation, the ScaleBits value for the Chroma scale is the maximum value of 4095 (all notes).

The notes from the User Scale are shown in real-time on the graphics as the ScaleBits value is changed.

**TIP :** Usually, select the chromatic scale. However, depending on the songs, selecting another scale may produce an interesting result.

**TIP :** The primary purpose of the pitch corrector is to correct a slightly out of tune vocal lines. This is especially useful in multi-part vocal harmonies. Further, it can be used to make special machine-like, formant shifting vocal effect.

The input must be a solo vocal, if possible, without any EQ, Reverb, etc.. (these can be applied later). Only effect that recommended before the pitch corrector is a compressor. The level should be even and not less than -20dB.

This offers 13 preset scales for Scale parameter. The pitch of the input signal is always corrected to the nearest pitch of the scale. In another word, if the deviation of the input signal is less than 40 cents (100 cent = 1 semitone), the result is always correct, even if you choose CHROMA, the chromatic scale which contains all 12 keys in octave.

In practice, however, especially when there is a large step in melody, the deviations in attack part of a new note are often much larger than that.

Based on this fact, it is recommended to choose the scale that contains as few notes as necessary, reducing the possibility of wrong correction. Try to find a scale, by changing the Scale and Key parameters, that contains the least notes that are used in the melody. It is very important as well to adjust the calibration base, i.e. CALIB, to the tuning of the recording.

If none of the preset scales fits to the melody, the user scale that you can edit, can be used.

**TIP :** When the correction is too perfect, it may sound artificially clean and unnatural, you may reduce the lower correction ratio than 100%.

Also, if you reduce the Smoothing parameter to less than 100%, small short-time fluctuations or a vibrato will not be smoothed out completely making the sound more natural.

## FX SNAPSHOTS

Snapshots of FX settings can be stored from any of the four FX unit channels in much the same ways as channel EQ and Dynamics. Recall of FX snapshots to any of the FX channels can also be automated.

Here's an example, storing the settings on FX channel 2 to a snapshot, then recalling it onto FX channel 4. In the FX page, select FX channel 2.

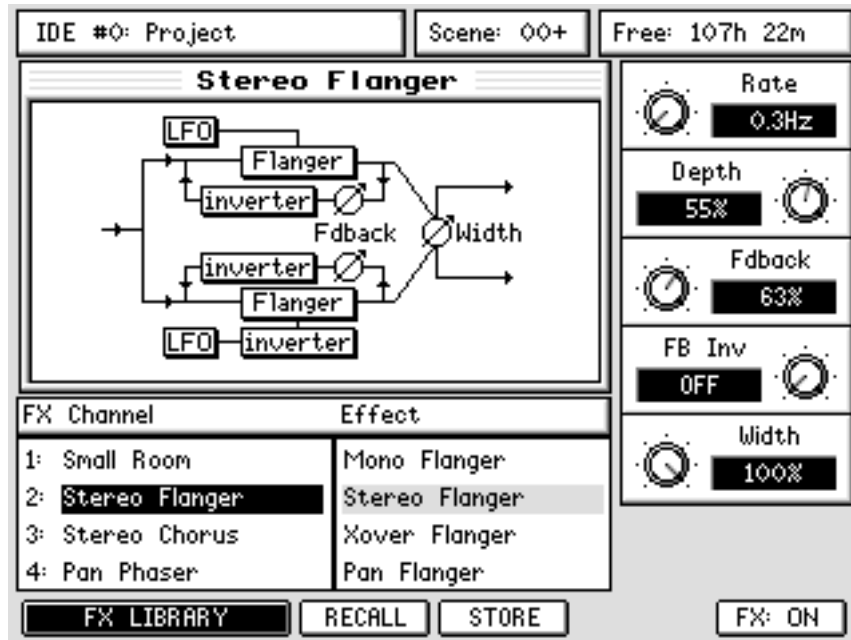

Press the MIXER SCENE STORE button to display the SNAPSHOT STORE page \_ it will already be set up to store a snapshot from FX CHANNEL 2:

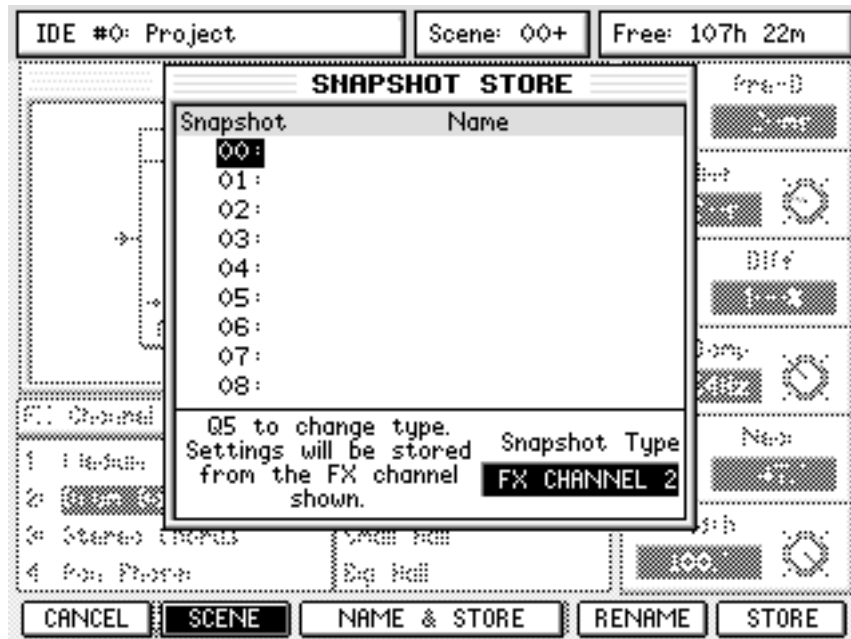

Select the snapshot ID you want to use with the cursor (you can use Q6 to scroll), and press the STORE (F6) button or ENTER to capture the settings on FX channel 2.



To recall the snapshot onto FX channel 4 select FX channel 4 in the FX page then press the MIX SCENE RECALL button to display the SNAPSHOT RECALL PAGE.

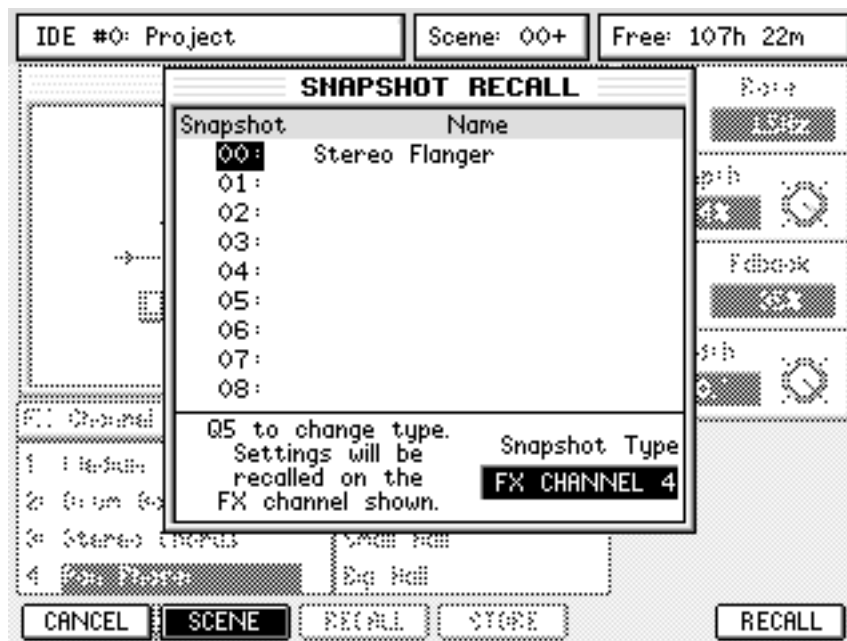

You can see that the default name for an FX snapshot is the name of the FX settings originally stored. Position the cursor on the snapshot you want to recall and press RECALL (F6) or ENTER. The FX settings contained in the snapshot saved from FX channel 2 will be recalled onto FX channel 4.

#### NOTES REGARDING FX SNAPSHOTS

**NOTE 1:** You don't have to launch the snapshot store and recall pages from the FX page to store and recall FX settings. Once in the Store or Recall page you can always set SNAPSHOT mode using the SCENE/SNAPSHOT button (F2) and set the Snapshot Type to the desired FX channel using the Q5 knob.

**NOTE 2:** To store FX presets from the global library as an automate-able snapshot simply recall the chosen preset onto an FX channel then store as a snapshot.

Conversely, storing snapshots into the global preset library can be achieved by recalling the snapshot onto an FX channel then storing the recalled settings as a preset.

**NOTE 3:** Edited effects are stored as part of the current Snapshot so that when you subsequently recall that snapshot, the correct effects assignment and their customised settings are recalled, even if the edited effect had not been stored as a Custom effect in the FX Library.

## EFFECTS SEND/RETURN LEVELS

Effects levels are governed by the amount sent to them via the FX sends on each channel. The MASTER FX/AUX SEND levels, however, are set using the default assignments in the USER BANK on Faders 1-4 (FX Sends 1-4) and Faders 5-8 (AUX Sends 1-4).

By default (Reset Mixer), all Master Send levels (AUX and FX) are set to 0dB.

The FX RETURNS (by default) appear on Faders 9-12 of the GROUP/FX Fader Bank and can have their levels automated and they may be muted and solo'd as on any other channel.

They can also be configured to use the FX/AUX sends so that effects can be sent to effects to create effects chains. However, they cannot be EQ'd. If you want to EQ (or otherwise process an effects return), the outputs of the effects channel should be patched to the inputs (see the description of the PATCH pages).

You can also view the position of all the Master Send and Return faders in either the MIXER page (Select: LEVEL) or the MIXER / MIXVIEW / INPUTS/FX/GROUPS page.

## SETTING UP MULTI-EFFECTS

Although some effects are multi-effects (chorus+delay, for example), these are essentially quite simple - useful but basic. However, it is possible to set up complex multi effects by sending FX returns to other FX channels. For example, with the following combination of effects...

FX1	Chorus
FX2	Phaser
FX3	Ping-Pong Delay
FX4	Large Hall

By sending a proportion of FX1 RETURN to FX2 (i.e. via FX2 send on the FX1 RETURN channel), you can add some phasing to the chorused sound. By sending a proportion of FX2 RETURN to FX3, echo can be added to that and by sending a proportion of FX3 RETURN to FX, reverb can be added. With combinations of pre- and post-fade sends, a great deal of flexibility is offered.

However, please note that the sends for the FX RETURN channels need to be configured to do this because, by default, the FX SENDS on the FX RETURNS are disabled.

## RECORDING EFFECTS

To actually record something with effects (i.e. commit the effects to disk during the track laying process), route the appropriate effects return channel to disk via the groups just like any normal channel.

For example, to record a pad sound coming in on Input Channel 4 with stereo chorus and reverb to Track 7/8...

1. Use FX1 and FX2 Sends to send a proportion of Input 4 to FX1 and 2 set up as chorus and reverb respectively. Route Input 4 to Group 7/8
2. In the GROUP/FX fader bank, route FX RETURN 1 and 2 to Group 7/8 as well (you might also like to send a bit of FX 1 RETURN to FX2 so that the chorus has a hint of reverb too). Balance the FX return against the 'dry' signal on Input 4.
3. Select Tracks 7/8 for record....

Input 4 AND the FX RETURNS will be recorded to tracks 7/8.

## ADDING EFFECTS TO A CONTROL ROOM MONITOR MIX

Very often, vocalists like to hear reverb on their vocals during the track laying process in order to have their performance 'flattered'. However, it's not a good idea to commit the reverb to disk at that stage.

To record a vocal coming in on Input 1 to Track 4 dry but with reverb 'monitoring'...

1. Route Input 1 to Group 4, select Track 4 for record.
2. Monitor the vocal line via Disk Channel 4.
3. Add a hint of reverb to Disk Channel 4. Route that reverb's FX RETURN to the L/R bus....

The vocal will be recorded 'dry' but the vocal reverb will be heard on the control room monitors and headphone output.

## ADDING EFFECTS TO A FOLDBACK MIX

Similarly, vocalists working in a vocal booth like to hear their voice with reverb in their headphones during the track laying process.

Using the same example as above and assuming AUX 3 and/or 4 are being used as pre-fade foldback mix outputs to the STUDIO outputs connected to a suitable headphone monitoring system....

1. Route Input 1 to Group 4, select Track 4 for record.
2. Monitor the vocal line via Disk Channel 4.
3. Use pre-fade AUX3/4 Send of Disk Channel 4 to send the vocal to the STUDIO outputs.
4. Add a hint of reverb to Disk Channel 4 but send the reverb return to the STUDIO outputs through pre-fade AUX 3/4 of the FX1 RETURN channel..

The dry signal will be recorded to disk, the vocalist will hear the backing track and his vocal via AUX 3/4 through the STUDIO outputs - he will also hear reverb on his vocal.

# PROJECT MODE

Pressing PROJECT shows this screen:

IDE #0: Project		Scene: 00+	Free: 107h 22m	
PROJECTS				
IDE #0	Internal HD	Volume : Akai DPS24		
Name	fs	Bit-Depth	Created	
◊ Suicide	44.1kHz	24-bit	10-Nov-2003	
Auto_Tes1	44.1kHz	16-bit	18-Sep-2003	
Auto_Tes2	44.1kHz	16-bit	18-Sep-2003	
Auto_Test	44.1kHz	16-bit	18-Sep-2003	
FOR Album CD2	44.1kHz	24-bit	20-Aug-2003	
Get Up Song	48kHz	24-bit	20-Aug-2003	
Julia	48kHz	16-bit	20-Aug-2003	
Messenger2	44.1kHz	16-bit	20-Aug-2003	
Project 1	44.1kHz	24-bit	10-Sep-2003	
Project	44.1kHz	24-bit	21-Aug-2003	
SELECT DRIVE		PROJECT TOOLS		NEW
				LOAD

Here, you can see a list of projects which may be loaded into the DPS24. The list also shows the date it was created.

Depending on the setting of the Project Info parameter in the SETUP / PREFERENCES, the sample rate and bit-depth of each project might also be shown.

**NOTE:** The current sample rate and bit-depth displayed in the project page is not a guarantee that all of the audio associated with a project was necessarily recorded with these settings. If the sample rate and bit depth of the project have been changed since audio was recorded into the project the audio may have a different sample rate and bit depth.

## LOADING PROJECTS

To load a project, simply use the CURSOR UP/DOWN keys or the Q6 knob to select the project and press LOAD [F6].

While a project is loading, a "Loading project. Please wait..." prompt is displayed.

Once the project is loaded, the DPS24 will take you directly to the MAIN SCREEN.

## CREATING NEW PROJECTS

It is also possible to create a new, empty project from scratch. To create a new project, simply press NEW [F5].

You will receive the usual naming prompt and you can enter a 16 character name of your own choosing. Press OK [F6] to confirm the name.

You will then be prompted to select whether you want to reset the mixer to the default factory settings or use the currently loaded project's mixer / patch settings:



If you are working in a studio where the same basic mixer / patch setup remains constant between projects (for example, you have a sampler connected to inputs 1 / 2 in stereo, a drum machine to inputs 3-6 as individual mono channels, a sound module / synth to inputs 7 / 8 in stereo, whatever) and this setup is re-used between projects, you will probably want to use the currently loaded project's settings.

If, however, you work in a studio where the setup constantly changes between projects, you might find it more convenient to reset to the factory defaults.

After selecting either option, the new Project will be created and you will be taken back to the MAIN page where you will see the new, empty project ready for recording into.

## RECORD / PLAYBACK FROM EXTERNAL SCSI DISK DRIVES

It is possible to record and playback using external disk drives connected via the optional IB-24SCSI, 68pin wide-SCSI interface.

In fact, it is now possible to use the DPS24 without any internal drives fitted at all which might be useful if you are recording with microphones close to the DPS24. Although the internal drive is relatively quiet, you can now house your drive away from the DPS24 for even quieter operation.

You can select the drive you want to use in the PROJECT mode:



Pressing SELECT DRIVE [F1/F2] takes you to this page:

IDE #0: Project	Scene: 00+	Free: 107h 22m
<b>SELECT DRIVE</b>		
INT HD	Name : Internal HD	IDE #0
<input type="text"/>	Format : FAT32	
SCSI	Name : External HD	SCSI #1
<input type="text"/>	Format : FAT32	
HOST	Name : Remote HD	HOST #0
<input type="text"/>	Format : FAT32	
HOST	Name : Remote HD	HOST #1
<input type="text"/>	Format : FAT32	
HOST	Name : Remote HD	HOST #2
<input type="text"/>	Format : FAT32	
<input type="button" value="EXIT"/>		<input type="button" value="SELECT DRIVE"/>

Select the drive you want use with the CURSOR UP/DOWN keys and confirm by pressing (not surprisingly!) SELECT DRIVE [F5/6]. You will be returned to the main PROJECT page where you may load or create new projects as normal.

Because it is possible to record to/playback from any internal IDE or external SCSI hard drive, you can see that the current Project drive's ID number is shown in the project name field top left of every page:

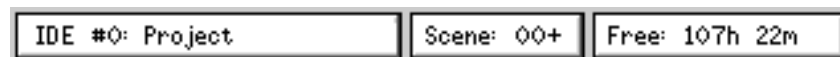

You can also select a USB HOST drive to be the source drive for the PROJECT TOOLS, but it is not possible to record/playback from a HOST drive. Therefore, both the LOAD and NEW functions are not operational when a HOST drive is selected.

In other words, a HOST drive can never be the current Project drive.

**NOTES ABOUT USING EXTERNAL DRIVES FOR RECORD/PLAYBACK**

- Using *SELECT DRIVE*, the contents of an alternate drive can be viewed whilst playing back from another.

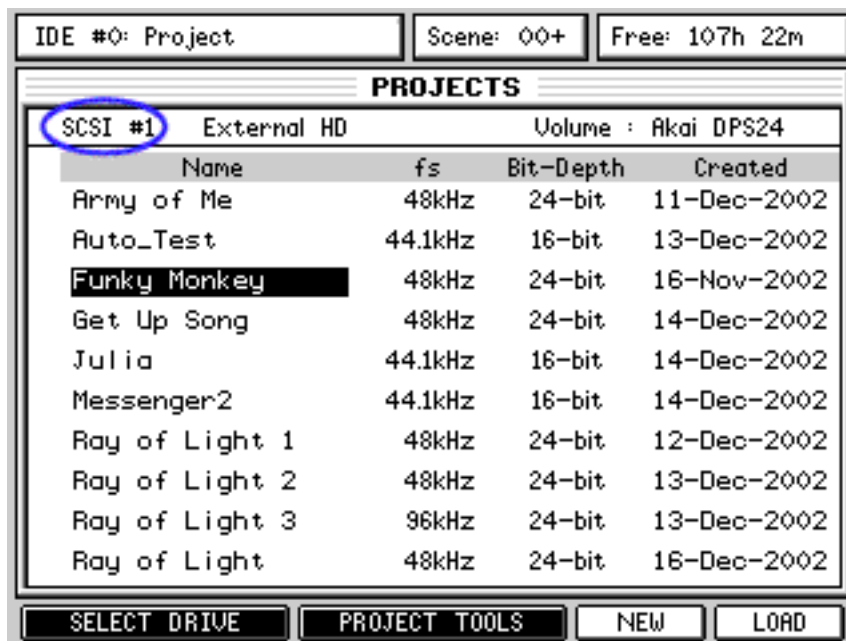

For example, in the above screen shot, you are viewing the contents of an external drive oSCSI #1 whilst a project from the internal drive on IDE #0 is actually loaded (and possibly playing).

The current drive only changes when a project from another drive is loaded. This means you can view projects on other drives while still being able to play the current project.

You can also use the *PROJECT TOOLS* for the selected disk so, in the above example, even though the 'project drive' is IDE#0, you could perform a backup or restore on the external SCSI drive. However, please note that you cannot backup or restore whilst playing or working on another project that might be loaded.

You can also select a *USB HOST* drive to perform a *Project Copy* from the *HOST* to the *DPS24*.

- When switching drives, the current edit clipboard is lost (to prevent the audio from projects spanning different drives). Use *WAV export/import* or *project copy* to transfer audio from one drive to another.
- Ordinarily with *SCSI*, there is a limit of 6 metres *TOTAL* cable length but if your drive is an *LVD* type, this can be extended. Please consult your drive's technical documentation for more details.
- It goes without saying that you cannot record to or playback from *CD-ROM*, *CDR* or *CD-RW*!!
- You will, of course, require the optional *IB-24SCSI* board to be installed in your *DPS24* in order to connect *SCSI* drives.

## MANAGING PROJECTS

In the main PROJECT page, the PROJECT TOOLS key [F3/F4] provides access to various 'project management' functions:

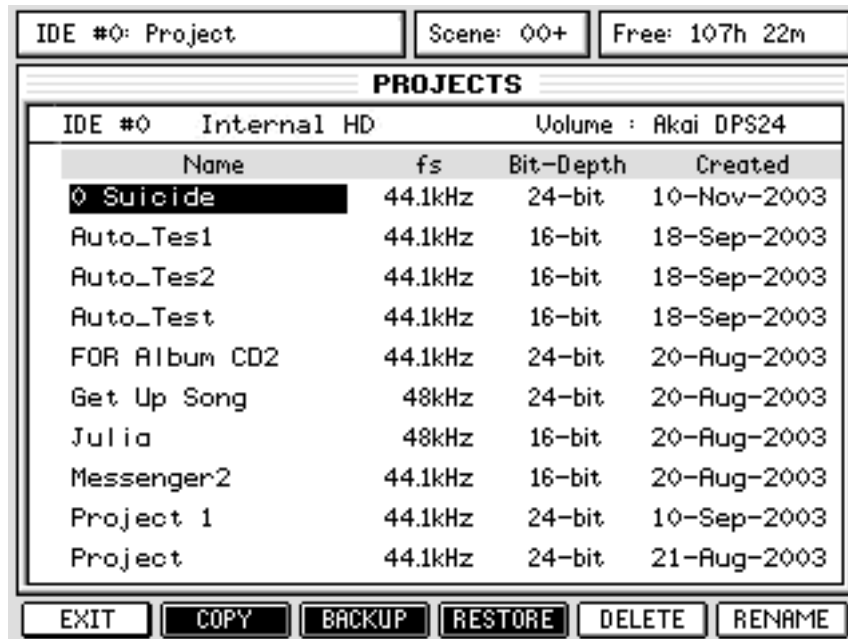

Here, you can copy, backup, restore, delete and rename projects.

To rename a project, use the CURSOR UP/DOWN keys to select the project to rename. Pressing RENAME [F6] will pop-up the usual naming prompt and you can rename the selected project in the usual way. Press OK [F6] at this prompt to confirm and commit the rename (or press CANCEL to abort).

To delete a project, use the CURSOR UP/DOWN keys to select the project to delete. Pressing DELETE [F5] will pop-up a prompt asking you to confirm the deletion. Press YES [F6] at this prompt to confirm the deletion (or press NO [F5] or the CANCEL key to abort).

**NOTE:** It is not possible to rename nor delete the current active Project. If you attempt to do so, you will receive a "Cannot rename current project" or "Cannot delete current project" message.



## DISK COPY

Pressing COPY [F2] shows this screen:

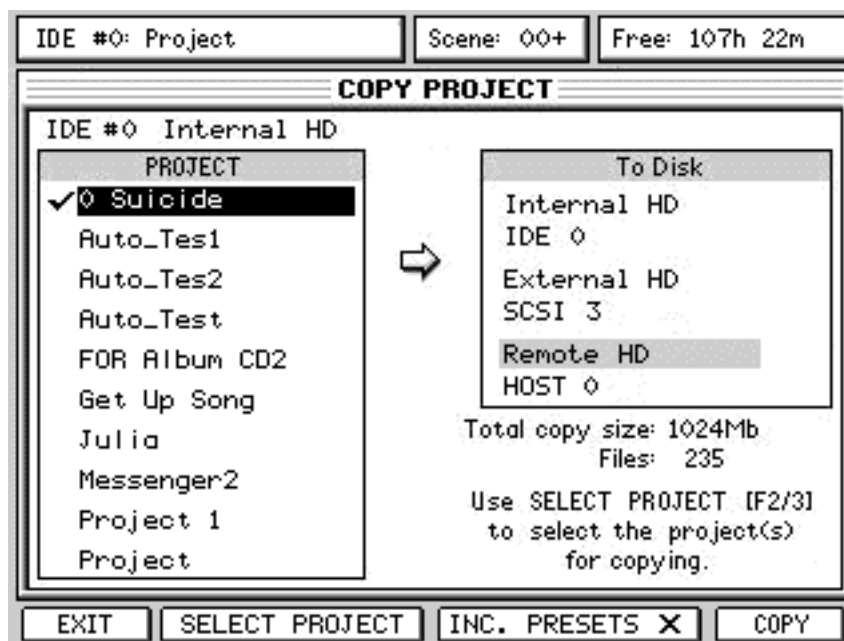

This page allows you to copy projects from a Hard Disk drive to another Hard Disk drive (with copies of the audio files used by the selected projects), or to copy project data (without audio) on the same Hard Disk drive.

The files to be copied are shown down the right hand side. Use the up/down cursors to highlight the project(s) you want to copy and press SELECT PROJECT [F2/F3] for each one you want to copy.

The selected items will be marked with a 'tick':

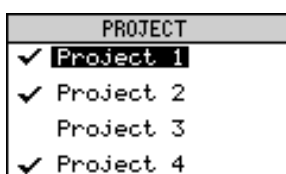

If you mistakenly select the wrong project, it can be de-selected by pressing SELECT PROJECT again.

As you select (and de-select) Projects, the Total copy size and number of files to be copied display fields are automatically updated.

Now move the cursor across to the right hand column on the screen and select the drive you wish to copy the projects to.

Once that is done and you are happy everything is selected correctly, press COPY [F6]. You will see a progress display as each file is copied.

## PROJECT COPY VIA USB

With akSysServer running on a computer connected to the DPS24 via the USB port, you will also be able to select HOST 0, 1, 2, etc.. as the "To Disk" destination for the COPY PROJECT function. To copy projects back from the HOST to the DPS24, select the HOST drive as the source drive using SELECT DRIVE in the main PROJECT page.

**NOTE:** When an HOSTdrive is selected, when you return to the main PROJECT page, you will see the list of projects on that drive as normal. However, because it is not possible to actually play/record projects directly from a HOST drive, the NEW and LOAD options do not appear:



## BACKING UP PROJECTS

Pressing BACKUP [F3] will show this screen:

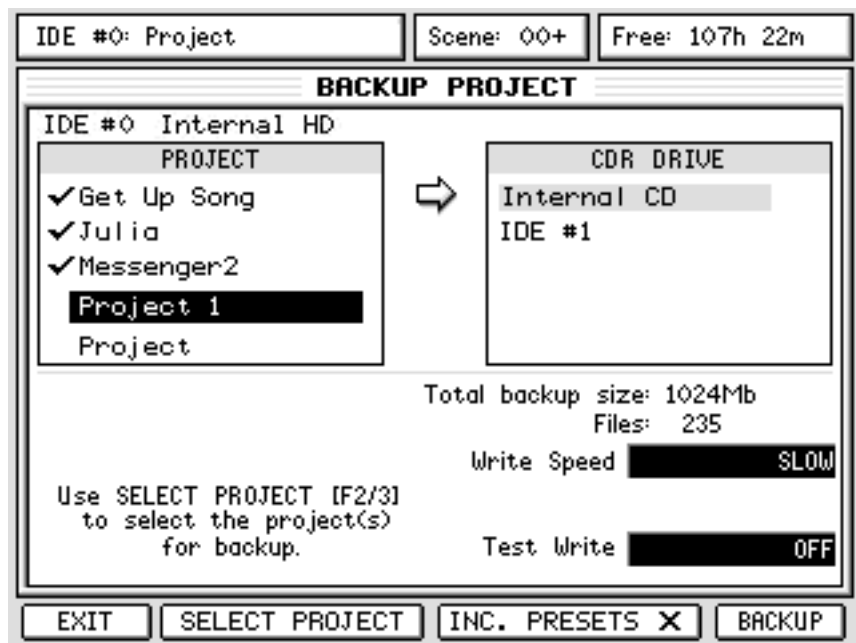

This page allows you to backup projects from a Hard Disk Drive onto a CDR drive.

You should use the CURSOR UP/DOWN keys to select the project(s) you want to back up and you should press SELECT PROJECT [F2/3] to 'mark' the files. The project(s) will be marked thus:

✓ Project 1

Multiple projects may be selected in this way for backup in one pass. E.g.:

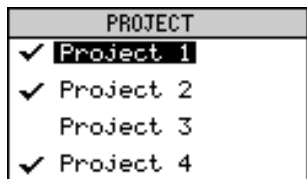

As in the COPY page, in the project BACKUP page, the DPS24 calculates a running total of the amount of data contained within the selected projects so that you can estimate how much space you need before you start backing up.

Before making the backup, you should set WRITE SPEED to the correct speed (SLOW if your CD-R/CD-RW is an older model, FAST if it is a later model) using Q5.

You can also select whether the drive will perform a TEST WRITE, a process in which a weak laser is projected onto the disc surface to check whether any malfunctions will occur during data transfer. If you have not written data to discs at all or, with a CD-RW, have only done so a few times, you should ideally perform the test write process. However, the selection is optional.

If you have an external CDR drive connected to the optional SCSI interface, you will also be able to select to backup to the Internal or External CDR drive in the CDR Drive list on the right side.

When you have selected the project(s) you want to backup and set the CD writing parameters as appropriate, press BACKUP [F6]. The backup process will commence and you will see a progress display.

If the total backup size is larger than the capacity of a CD, when the current CD gets full, you will be prompted to insert blank CDs as required. Make sure that you label the multiple backup CDs in the order that they are created (i.e., CD#1, CD#2, ...) as they will need to be restored in the same order.

## BACKING UP FROM EXTERNAL HARD DRIVES

Using SELECT DRIVE in the main PROJECT page, it is possible to nominate an external drive as the source for projects to back up to CD.

The process is simple - use SELECT DRIVE to select the drive you want to back up from and press BACKUP. The process is exactly the same as described for the Internal HD, except, of course, that you are backing up an external drive.

## COPY/BACKUP/RESTORE USER PRESETS

It is also possible to copy/back/restore any user presets you may have created. These include FX library presets, Patch presets, EQ, Compressor, Noise Gate and MBCX libraries.

They can be included with projects when backing those up or they can be copied/backed up (and restored) on their own. This way, not only can you keep safety copies of your custom presets but you can also send them to friends or colleagues who have a DPS24.

This function is found in the COPY and BACKUP pages in PROJECT TOOLS:



To include the presets with a project copy/backup, simply press F4 or F5 so that it is 'checked'.

To copy/backup only the presets, press INC. PRESETS but don't select a project for copy/backup.

To restore, follow the usual restore procedure.

When restoring this data, the restored FX library is merged with the current one with effect names being changed as appropriate to prevent duplicate names.

**NOTE:** If the FX library becomes full as you fill it up with restored presets, you will be prompted accordingly. The maximum number of effects entries the library can accommodate is 256 effects.

EQ/COMP/N.GATE/MBCX and PATCH Presets are also renamed if an existing preset has the same name.

**NOTE:** Like restoring projects, restoring a backup of the presets may result in multiple presets with the same 'values' but with different names.

## RESTORING PROJECTS

Pressing RESTORE [F4] shows this screen:

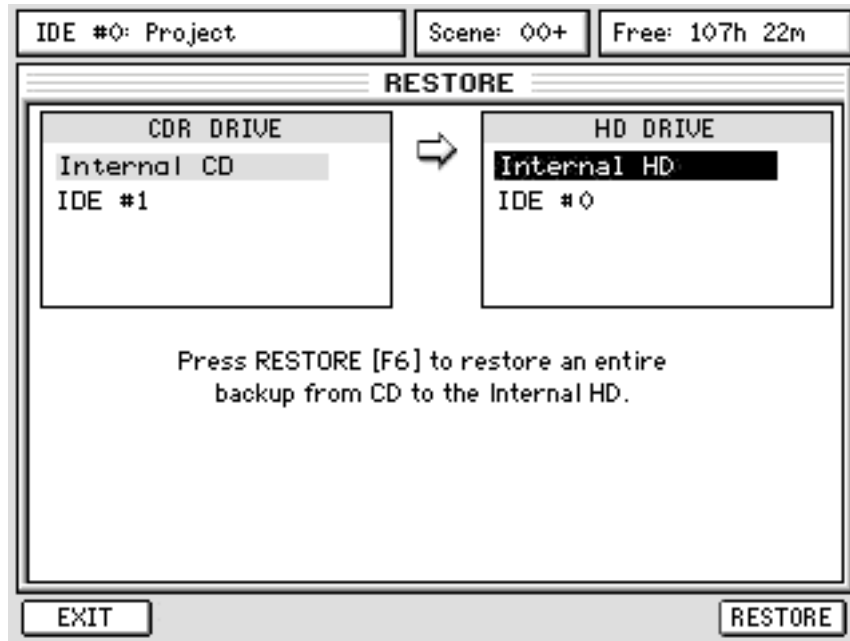

This page allows you to restore a backup from a CDR drive onto a Hard Disk Drive.

If you have connected external drives to the optional SCSI interface, you can select the source CDR drive (Internal or External) in the CDR Drive list on the left and the destination HD Drive in the HD Drive list on the right, using the cursors.

To restore a backup, press RESTORE [F6]. You will receive an "ARE YOU SURE" prompt and you should respond accordingly. If you proceed, you will see a progress display.

If the backup exists across several CDs, you will be prompted to insert the appropriate CD during the backup process (always start with CD#1).

## RESTORING TO EXTERNAL DRIVES

When restoring CD back-ups, the external hard drives will appear in the HD Drive column - select the drive you want to restore your back-up to and follow the procedure described above.

# VIRTUAL TRACKS

Pressing SHIFT+PROJECT gives access to the 'virtual' tracks function:

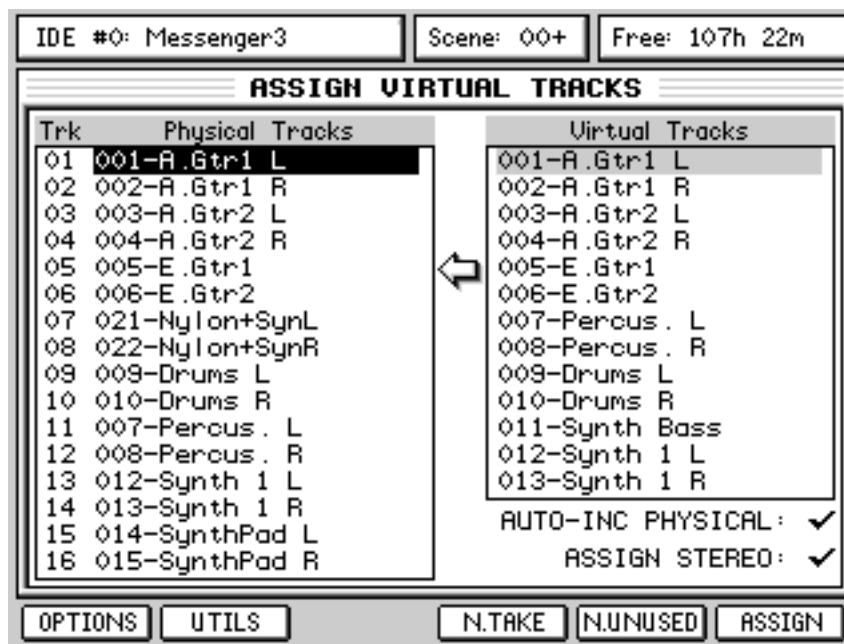

To assign a virtual track to a 'physical' track, first select the 'physical' track you wish to replace using the CURSOR UP/DOWN keys. Once the track you want to replace is selected, press CURSOR > to move to the list of VIRTUAL TRACKS and use the CURSOR UP/DOWN keys to scroll through them. When you find the virtual track you want to use, press ASSIGN to assign that virtual track to the physical track.

Physical and virtual tracks can be named/renamed and/or erased. At any time, you can revert to the original 'physical' recordings by pressing DEFAULT - this will restore the original track(s).

The principle behind virtual tracks is that it is possible to swap out recordings that exist on 'physical' tracks with a library of 'virtual' tracks. In this way, you can record several different versions of a guitar solo or vocal or whatever and use the best one. For example, you could record a guitar overdub on Track 4 but you think you might be able to better. But, rather than just record over the original, you could swap Track 4 out with an empty virtual track and record onto that... you can keep doing this as many times as you like (well, 232 to be precise: 256 virtual tracks minus the 24 'physical' tracks). The new functions make the swapping out of tracks and assignment of virtual tracks much easier and quicker. The function along the bottom are:

- OPTIONS Provides options that relate to the V-Track function (more later).
- UTILS Provides various utilities that relate to the V-Track function (more later).
- N.TAKE This creates a new take on the selected 'physical' track. What it does is find the first unused 'virtual' track, performs an 'auto-name' that is based on the 'physical' track's name and swaps out whatever is on the selected 'physical' track with the new, blank take.

**NOTE:** The N.TAKE function will not swap out tracks if there is no audio on them.

N.UNUSED Automatically finds the next unused 'virtual' track and assigns it to the selected 'physical' track. It is similar to the NEW TAKE function but without the auto-name process.

ASSIGN Allows you to manually select a 'virtual' track and assign it to the selected 'physical' track.

However, since a V.Track can only be assigned to one Physical Track at a time, it is not possible to assign a V.track that is already assigned to another Physical track without unassigning it first. You will be prompted if you attempt to assign a V-Track that is already in use on another 'physical' track.

## UTILS

Pressing UTILS shows this extra functionality:

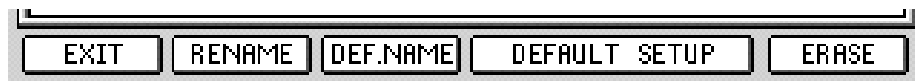

The functions are:

- EXIT Returns you to the main V.Tracks page.
- RENAME Allows you to rename a 'physical' and/or 'virtual' track. The usual naming prompt is shown when this is pressed.
- DEF.NAME Allows you to assign a default name to the selected V-track.  
If the V.Track is empty (no audio), the default name will be "<unused>".  
Otherwise, the default name will be "V.Track nn-xxx" where 'nn' is the number of the physical track it is assigned to ('nn' will be '??' if the V.track is not assigned to any physical track), and 'xxx' is an auto-incremented number.
- DEFAULT SETUP Pressing this will re-assign 'virtual' tracks 1-24 to 'physical' tracks 1-24. You are prompted - respond accordingly.
- ERASE Allows you to erase 'virtual' tracks.

**NOTE:** This function has no UNDO. Please proceed with caution. You are prompted to this effect - you should respond accordingly.

It should be mentioned that the V.Track function is not only useful for repeated attempts at the same recording or overdub (like re-recording the same guitar part or vocal or whatever over and over again)... you could find yourself in a situation where, for example, you lay down a guitar part but think that maybe a keyboard part might be more appropriate. Or you could lay down a synth bass line and think it might be better done with a different sound. Neither of these scenarios are a problem... simply use the V.Track function to try out different ideas on the same track(s). The beauty is that you are not committing yourself to anything until you need to.

## USING THE VIRTUAL TRACKS

To make operation clearer, we'll run through a typical real-world application for the V-Track function. OK.... we'll imagine you've just recorded an electric guitar solo onto Track 6. It's good but you think you might be able to do better. You don't want to record over it - you just want to have another go at it in case you can do a better job. In the V-TRACKS page, place the cursor on Physical Track 6:

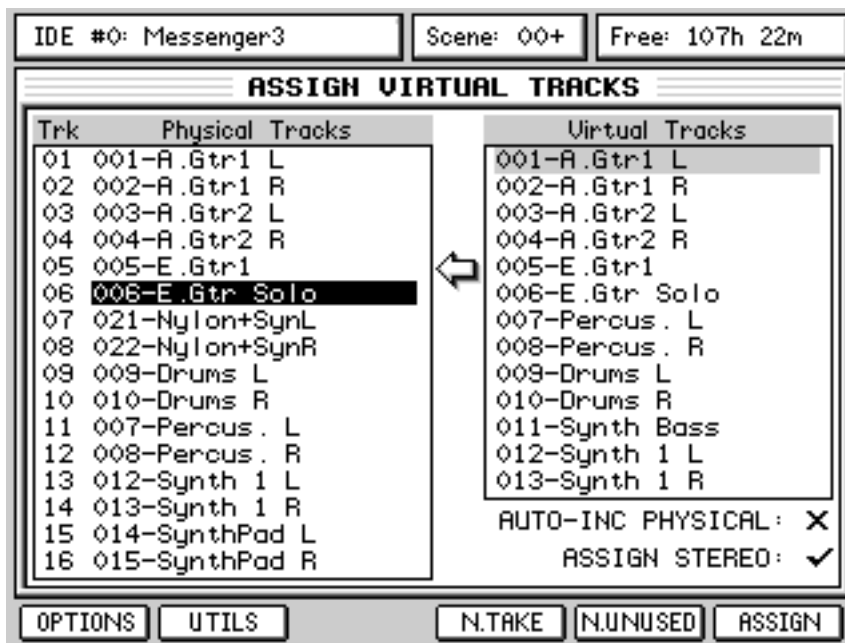

Press N.TAKE [F4]. The first unused 'virtual' track will be found, auto-named and assigned:

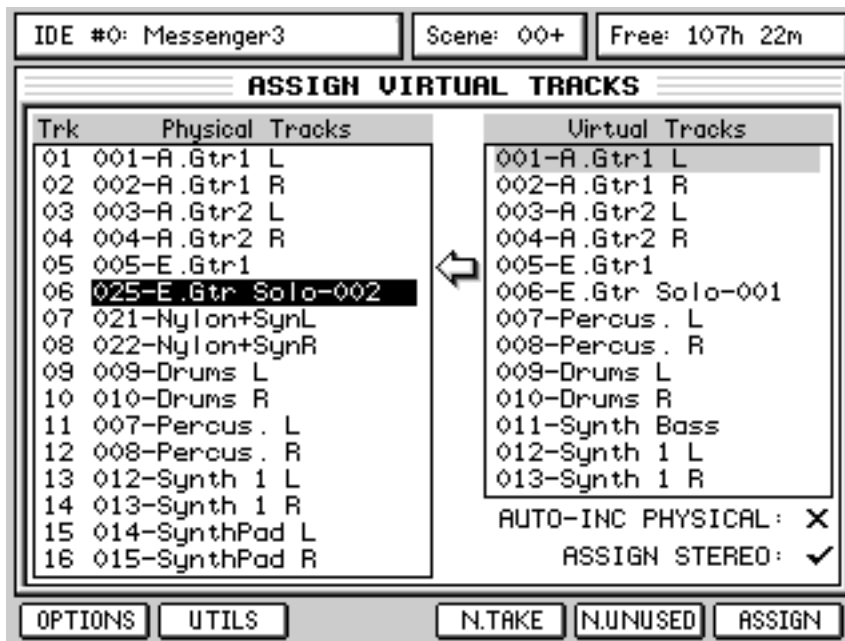

You can see that 'virtual' Track 25 has been used and the original name has been given a unique numeric identifier at the end of the name -001 appended to the original now on V.Track 6, and -002 for the new version assigned to 'physical' Track 6.

You can now record a new guitar solo onto track 6 whilst safely retaining the original recording.

If you were to repeat the process, you'd see this:

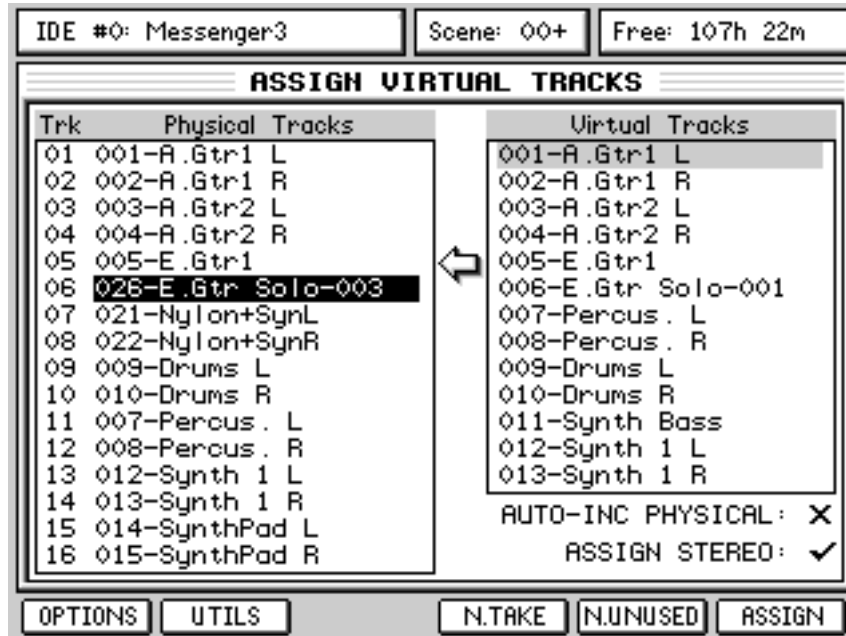

The original guitar part is on V.Track 6, the second pass is on V.Track 25 whilst the new one uses V.Track 26 and has been assigned to 'physical' track 6 ready to record into.

You can repeat this process as many times as you like until you have the perfect take. If you think a take you recorded previously was better, you can always use that - move the cursor to the appropriate V.Track and use the manual ASSIGN key on F6.

Of course, this process can be performed on any 'physical' track (or pair of tracks). However, the DPS24's implementation of 'virtual' tracks differs from other systems. Whereas most systems limit you to a fixed number of 'virtual tracks' per 'physical' track, the DPS24 has 256 V-Tracks that are freely assignable to any 'physical' tracks. On other systems, you are basically only allowed a fixed number of attempts at different takes before you hit the limit and you have to start making decisions about which takes to keep and which ones to lose to make room for other attempts.

The DPS24, on the other hand allows you up to 256 attempts at a take for just one single 'physical' track if you want (although if it takes that many attempts to get a recording right, you should really consider doing something else ;-)

Having got the basics out of the way, let's now have a look at those functions on F1 and F2.



## OPTIONS

Pressing OPTIONS will show these extra functions:

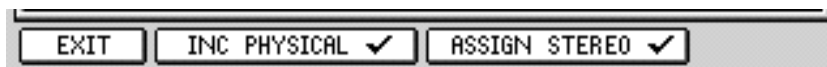

With INC PHYSICAL checked, when you assign a V.Track to a physical track, the cursor will automatically move down to the next 'physical' track (and the next 'virtual' track).

In this way, you can quickly swap out physical tracks with virtual tracks without having to manually move the cursor around.

With ASSIGN STEREO checked, any tracks that were paired as stereo will be dealt with automatically in any of the V.Track swapping functions.

So, for example, if Tracks Channels 7 and 8 were linked as a stereo pair, and V.Track 25 is assigned to Physical Track 7, V.Track 26 will automatically be assigned to Physical Track 8.

**NOTE:** As for the WAV Export feature, Tracks are identified as Stereo tracks when their Mixer Channels are paired.

The status of these options is shown in the main V-Tracks page:

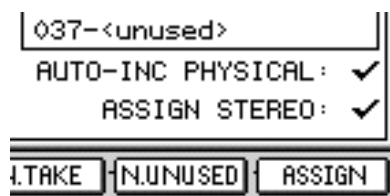

# SETUP MODE

The SETUP page allows you to set certain functions that affect the DPS24 as a whole. Pressing SETUP shows this page:

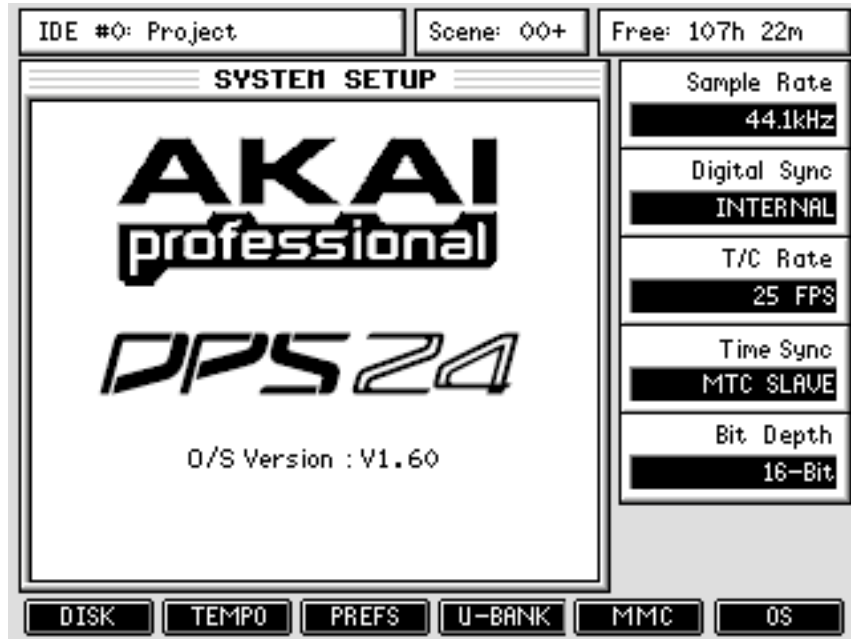

Here, you can set the following functions using Q1-Q6:

**SAMPLE RATE** Here, you can set the sample rate for the DPS24. The options are 32kHz, 44.1kHz, 48kHz, 88.2kHz and 96kHz

**NOTE:** The mix processing, track count and FX are reduced by half when using the high sample rates (88.2kHz or 96kHz).

When a project is loaded and already contains audio, should you attempt to change the sample rate, you will be prompted:



You should respond accordingly.

As the prompt advises, please bear in mind that changing the sample rate will cause the project to play back at the wrong speed.

DIGITAL SYNC	Selects the digital clock source. The options are:
INTERNAL	The DPS24 will sync to its own internal clock
WCLK	The DPS24 will sync to a sync source connected to the Wordclock BNC connector on the rear of the DPS24.
SPDIF	The DPS24 will sync to a digital audio source connected to the co-axial digital input on the rear of the DPS24.
ADAT 1..8	The DPS24 will sync to a digital audio source connected to the optical digital input on the rear of the DPS24.
ADAT 9..16, 17..24	The DPS24 will sync to a digital audio source connected to the selected optical digital input on the ADAT option board.

External clock should match the sampling rate set for the current project.

**NOTE:** If the selected digital sync source is not available, you will receive a prompt informing you. Also, to prevent unwanted noise, all audio is automatically muted and the top of the LCD will show:



Certain operations will also be unavailable to you on the DPS24.

To remedy this situation, you should either select INTERNAL or you should attend to the digital sync source's problem.

T/C RATE Sets the SMPTE/EBU TimeCode rate. The options are 24 FPS, 25 FPS, 29.97 FPS, 29.97D FPS, 30 FPS and 30D FPS.

The T/C RATE should match any incoming external timecode. If it does not, synchronisation will slip.

TIME SYNC This sets how the DPS24 will behave with respect to receiving and/or generating timecode when the EXT SYNC key is enabled.

The options are:

OFF	
MTC SLAVE	The DPS24 will follow external MIDI timecode allowing it to synchronise to external sequencers, drum machines, etc..
MTC MASTER	The DPS24 will generate MIDI timecode allowing sequencers, drum machines, etc., to follow the DPS24.
MIDI CLK OUT	The DPS24 will generate MIDI clock with Song Position Pointer to act as a master controller for external sequencers, drum machines, etc..
SMPTE SLAVE	The DPS24 will follow external SMPTE timecode via the optional SMPTE card.

**NOTE 1:** The TIME SYNC options are enabled/disabled using the EXT. SYNC key.

**NOTE 2:** The SMPTE board (if installed) always generates SMPTE timecode during playback.

Using SMPTE SLAVE, it is possible to record to timecode that is not playing at nominal speed, only if Digital Sync is set to Internal. In this case, the DPS24 can record in sync with a fluctuating timecode source and will subsequently play back accurately. This is useful when running the DPS24 alongside analogue reel-to-reel MTRs that can exhibit less than perfect play speeds.

**NOTE:** *One important thing to consider when working with timecode that is less than perfect is that if something recorded to off-speed timecode but is subsequently played with perfect timecode, the playback will alter. For example, imagine you record to timecode that is running 1% slow - the DPS24 will record 1% slow and will playback in sync to that external, off-speed timecode. However, if you subsequently play that recording back to perfect timecode, it will play back 1% faster. The same applies when playing back "wild", i.e. without external sync,*

**BIT DEPTH**            The options are 16-bit or 24-bit. This sets the bit-depth for any subsequent recordings you make. A project can contain recordings made at different bit depths.

If this parameter is changed after recording, it does not affect the bit depth of the existing recordings.

These and other SETUP settings are saved to disk as part of the current project and will subsequently be recalled when that project is loaded.

The soft keys on the main setup page are:

- |             |   |
|-------------|---|
| DISK [F1]   | Takes you to pages where you can manage your disk drive(s) with functions such as formatting, copying, etc..  |
| TEMPO [F2]  | Takes you to a page where you can set tempo maps. This functionality is only really necessary if you are synchronising an external sequencer to the DPS24 and need to have tempo changes in the song. |
| PREFS [F3]  | Takes you to a page where you can set certain preferences.  |
| U-BANK [F4] | Takes you to a page where you can set up the USER BANK of faders.   |
| MMC [F5]    | Takes you to a page where you can set up the MMC operation mode.  |
| OS [F6]     | This takes you to a page where you can update the DPS24's operating system software.  |

## MMC SETUP

This page allows separate MMC device IDs to be assigned for MMC transmit and MMC Receive. Pressing MMC shows this page:



SEND ID sets the MMC ID for transmission - this should match the ID of the machine you want to control. ID 127 is "Broadcast" to all connected MMC machines.

RECEIVE ID sets the MMC ID for control by external machines. The setting here should match the MMC ID of the controlling device.

It is possible to nominate whether the DPS24 is an MMC master or slave using the MASTER/SLAVE parameter.

## TEMPO MAPS

Pressing TEMPO in the main SETUP page takes you to this page:

IDE #0: Project		Scene: 00+		Free: 107h 22m	
TEMPO MAP					
Song Start: 00:00:10:00					
Step	Bar	Beat	Clock	Type	Value
1	0001	01	01	Tempo	120.0
2	0001	01	01	Time Sig	4/4
3	0006	01	01	Tempo	122.5
4	0014	01	01	Tempo	119.0
5	0023	01	01	Tempo	120.0

EXIT    RESET START    DELETE    TEMPO    T.SIG

Here, you can set up a 'Tempo Map' so that a sequencer that is being synchronised to the DPS24 via MIDI CLOCK can follow time signature and/or tempo changes.

The Tempo Map is also used by the DPS24 for calculating its own BARS/BEATS/CLOCK display (enabled using the dedicated DISPLAY SELECT key next to the LED Time Display).

The first thing you should do when creating a tempo map is identify the start of the song and reset the start time so that the song starts at Bar 1, Beat 1, Clock 1.

The Song Start time is always shown as SMPTE/EBU at the machine's currently selected T/C RATE. To set the Song Start time, locate to the start of the song and carefully jog over it until you have the exact start point. Now press RESET START [F2/3].

All tempo changes and/or time signature changes you enter into the map will now be referenced to that song start point.

However, please note that in the MAIN SCREEN, pressing COUNTER RESET [F2] will not only reset the relative timecode to 00:00:00:00 but will also reset the SONG START in the TEMPO page.

If you want the song start to be offset relative to 00:00:00:00, you can then use RESET START [F2/3] in the TEMPO page. As a practical example....

With ABS(olute) timecode display selected, locate to 00:00:30:00. Switch to REL(ative) timecode and press RESET - the dedicated timecode display will show 00:00:00:00.

Now move forward, say, 15 seconds. In the TEMPO page, press RESET START [F2/3] - the song start will be at 15 seconds (45 seconds in absolute time):

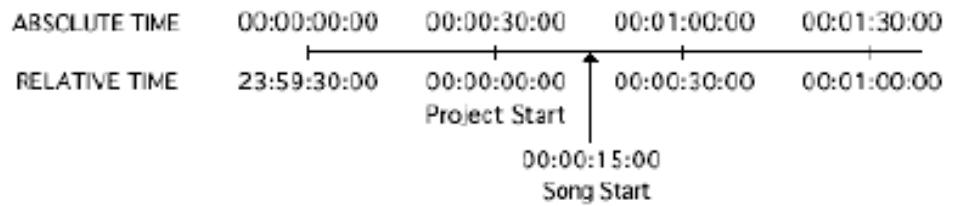

You will see that there is a tempo and time signature entry at the start of the song. These determine the map's starting tempo and cannot be deleted.

You may edit them, however, to something more suitable simply by moving to the VALUE field and entering the tempo and time signature. Time signature values can be edited using the +/- keys of the numeric key pad or using Q5. Tempo values can also be entered directly via the numeric key pad.

After that, to add more steps to the map, first play/spool/jog/whatever to the point where you want the first change to be and press either T.SIG (to add a time signature) or TEMPO (to add a tempo change). No prompts are issued - an event is simply inserted. If you add an event accidentally, simply press DELETE (F4).

**NOTE 1:** Because tempo and time signature changes can only occur at the start of a bar, adding a tempo or time signature event will place it at the start of the current bar.

**NOTE 2:** It is not possible to have several time signature/tempo changes at the same time.

This is mentioned because you may attempt to enter a time signature/tempo change and nothing appears to happen. Chances are that a change even already exists at that bar.

The cursor will automatically be placed on the step you have just created and you may edit it's value (the default step value for tempo is 120.0 BPM and for time signature it is 4/4 - these should be edited as appropriate).

Continue adding tempo changes and new time signatures as you need through the project. As usual Q6 will allow you to scroll quickly up/down the list.

## PREFERENCES

Back in the main SETUP page, pressing PREFS [F3] takes you to this page:

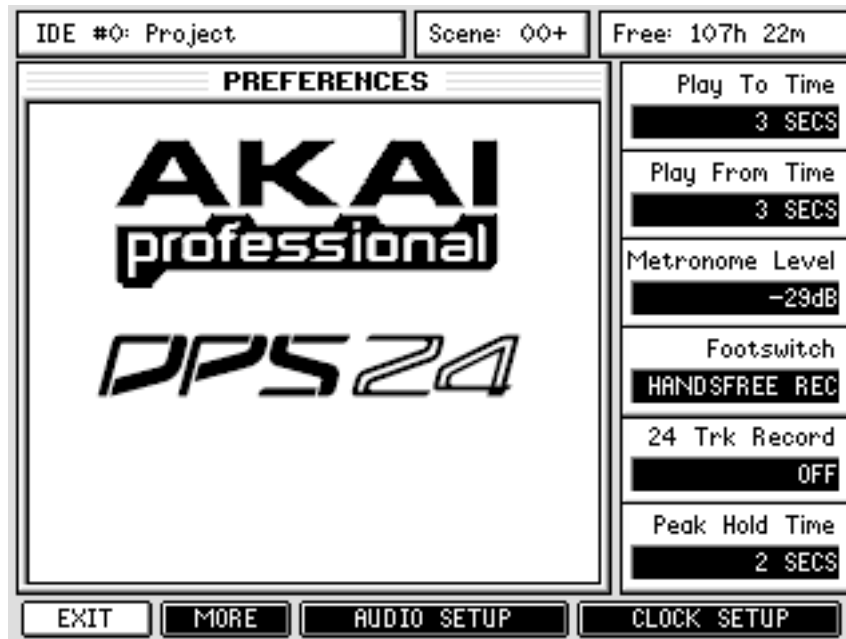

The options are:

PLAY TO	Sets the 'pre-roll' time for the PLAY TO key. The PLAY TO range is 0-99 seconds.
PLAY FROM	Sets the 'post-roll' time for the PLAY FROM key. The PLAY FROM range is 0-99 seconds.

**NOTE:** *PLAY TO time + PLAY FROM time = PLAY OVER time.*

METRONOME	Sets the level of the metronome function.								
FOOTSWITCH	Allows you to select the function of the footswitch input. The options are: <table> <tr> <td>HANDSFREE REC</td> <td>The footswitch can be used for playing, stopping and dropping in and out of record. Pressing the footswitch once will cause the DPS24 to play, pressing it again will cause it to drop into record on the selected track(s). Pressing it again will cause it to drop out of record and pressing it again will stop playback.</td> </tr> <tr> <td>PUNCH IN/OUT</td> <td>When the DPS24 is playing, pressing the footswitch once will drop into record on the selected track(s) and pressing it again will cause it to drop out of record. Pressing it again will drop into record again and pressing it again will drop out. And so on.</td> </tr> <tr> <td>PLAY/STOP</td> <td>Allows you to start and stop playback using the footswitch.</td> </tr> <tr> <td>ADAT LRC</td> <td>Allows you to use an ADAT LRC as a simple remote. LRC key assignment is described in the Appendix section.</td> </tr> </table>	HANDSFREE REC	The footswitch can be used for playing, stopping and dropping in and out of record. Pressing the footswitch once will cause the DPS24 to play, pressing it again will cause it to drop into record on the selected track(s). Pressing it again will cause it to drop out of record and pressing it again will stop playback.	PUNCH IN/OUT	When the DPS24 is playing, pressing the footswitch once will drop into record on the selected track(s) and pressing it again will cause it to drop out of record. Pressing it again will drop into record again and pressing it again will drop out. And so on.	PLAY/STOP	Allows you to start and stop playback using the footswitch.	ADAT LRC	Allows you to use an ADAT LRC as a simple remote. LRC key assignment is described in the Appendix section.
HANDSFREE REC	The footswitch can be used for playing, stopping and dropping in and out of record. Pressing the footswitch once will cause the DPS24 to play, pressing it again will cause it to drop into record on the selected track(s). Pressing it again will cause it to drop out of record and pressing it again will stop playback.								
PUNCH IN/OUT	When the DPS24 is playing, pressing the footswitch once will drop into record on the selected track(s) and pressing it again will cause it to drop out of record. Pressing it again will drop into record again and pressing it again will drop out. And so on.								
PLAY/STOP	Allows you to start and stop playback using the footswitch.								
ADAT LRC	Allows you to use an ADAT LRC as a simple remote. LRC key assignment is described in the Appendix section.								



24-TRACK RECORD Enables/disables the 24-Track Record mode.

Normally, when this parameter is OFF, the maximum number of audio sources you can record simultaneously is 16.

When it is ON, the 24-Track Record mode allows you to record more than 16 separate sources at any one time.

It is useful when you need to record more than 16 tracks simultaneously, up to 24 - for example, 12 analogue inputs, 8 ADAT inputs (for instance from a 8-Channel preamp/AD with ADAT output), the stereo AUX input and the stereo 2-TRACK input, or the stereo SPDIF (a total of 24 tracks).

This also allows performing a one-pass transfer from a 24-track ADAT system (with the IB-24ADT ADAT option board installed).

**NOTE:** When 24 TK RECORD is enabled, tracks 21-24 cannot be used for playback. After performing a 24-track recording to the DPS24, you should switch 24 TK RECORD OFF in order to play the 24 tracks you have just transferred.

PEAK HOLD TIME Sets the Peak Hold Time for the meters (both for the LCD and akSys):

The range is OFF - 1 SEC - 2 SECS - 5 SECS - 10 SECS - 20 SECS - INFINITE. When INFINITE is selected, the peak hold indicator stays on permanently. The setting made here also affects the meter display in ak.Sys TrackView.

**NOTE:** The peak hold time preference is unique to each project and so should be set separately.

The MORE [F2] key provides access to more Preferences:

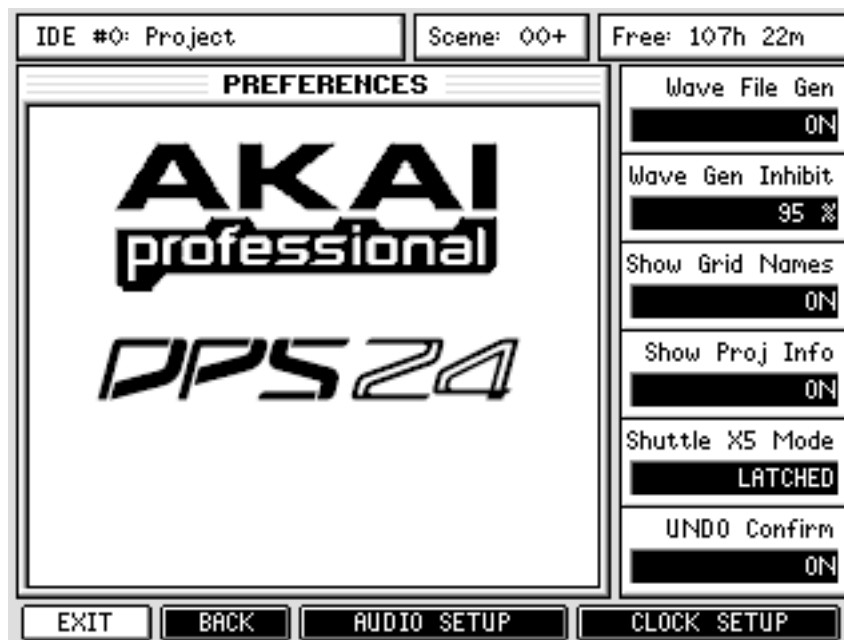

## WAVEFORM GENERATION

In order for waveforms to be shown in ak.Sys, it is necessary to first enable a new parameter found in SETUP / Prefs / MORE.

The WAVE FILE GEN [Q1] causes the DPS24 to calculate each audio files waveform for display in ak.Sys. This is a background function and has no impact on the DPS24's operation.

When the WAVE GEN function is enabled, the MAIN and EDIT screens show the DPS24's background status with a small icon next to the NOW indicator:

The waveform files are actually stored on disk and so do use some disk space. However, don't be alarmed because the waveform files are relatively small. For example, a 10 second 16-bit recording will be around 1Mb but its waveform file is less then 4kb.

Although principally included to show waveforms in ak.Sys, this function also benefits waveform display when using the DPS24's editing functions and it is possible to zoom out much further when Wave File Gen is enabled:

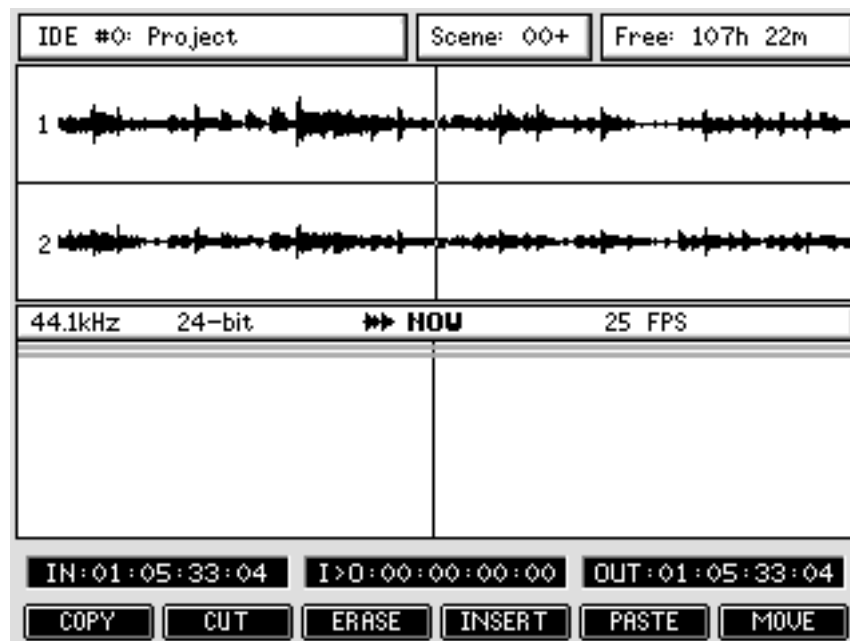

If you try to zoom out on a track before the waveforms are calculated, you will get the following message in place of the waveform:

Waveform data not yet available

In practice, you shouldn't notice the waveform generation function as it all takes place in the background. If you are not using ak.Sys or do not need to zoom out very far in the EDIT pages, you can turn the function off and leave it off. However, if you do switch the function off and attempt to zoom out too far in the EDIT pages, you will be prompted:

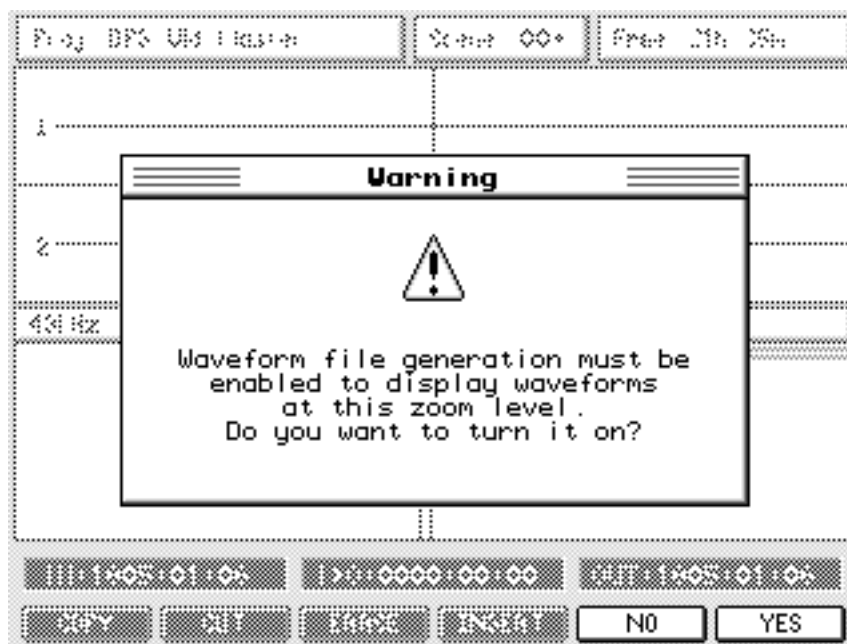

You should respond accordingly.

A similar message will be displayed if you start ak.Sys with waveform generation switched off.

Because some disk space is used, you can reserve a portion of the disk so that after a certain percentage, the generation of waveforms will be inhibited and the remaining space used exclusively for audio recording and projects.

This is set in the WAV GEN INHIBIT [Q2] parameter.

For instance, with a 75% setting, when the disk is 75% full, waveform generation will be inhibited.

If waveform generation is inhibited this icon  is shown next to the NOW display.

**NOTE:** When you perform a CLEANUP operation, the waveform files for the deleted audio are also removed.

## TRACK NAMES IN GRID

Track names are now shown in the GRID view (SHIFT+MAIN):

However, if you don't want them shown for whatever reason, they can be optionally switched on or off in the SETUP / PREFS / MORE page using the SHOW GRID NAMES [Q3] option.

## PROJECT INFO

Because the sample rate and bit-depth info has to be calculated each time you enter the PROJECT page, this will cause a slight delay before the PROJECT page is displayed. If you have just a few projects on disk, it is unlikely that you will notice any difference.

If, however, you have lots of projects on disk, you may notice a small delay before the PROJECT page is displayed.

If you prefer to have faster access to the PROJECT page, you can disable the 'project info' display in SETUP / PREFS > MORE page using the SHOW PROJ INFO [Q4] option.

The default for this preference is ON but this can be switched OFF if you prefer to have more immediate access to project loading / creation.

## SHUTTLE X5 MODE

It is possible to select how FF and REW 'shuttle' will perform.

A unique feature of the DPS24 is its ability to rewind and fast forward in PLAY with 'tape chatter' just like analogue reel-to-reel tape machines.

By default, this is achieved by pressing FF or REW when the DPS24 is playing... the DPS24 will go into this 'tape chatter' shuttle playback mode (at 5 times the nominal speed) until such time as PLAY is pressed (to resume playback) or STOP is pressed. This is ideal if you have long recordings to shuttle through.... you can just press the key, sit back and wait until you're at the point you want to be.

However, it is also possible for the function to emulate the way some reel-to-reel tape machines worked which is that you press and hold the REW or FF keys.

The SHUTTLE X5 MODE [Q5] option allows you to selected LATCHED (the default operation) or MOMENTARY.

When MOMENTARY is selected, when the DPS24 is in PLAY, if you only press the REW or FF key, the DPS24 will go into "normal" high-speed rewind or fast-forward (no audio) until PLAY or STOP is pressed.

To use the x5 shuttle (with audio), you have to press and hold both the PLAY key and either the REW or FF key, and then release the REW or FF key at the appropriate moment... the DPS24 will revert to playing back at normal speed.

## UNDO CONFIRMATION

It is possible to display a pop-up to confirm that an UNDO (or REDO) operation has been successfully completed and also there will be an indication when there is nothing to undo.

With UNDO CONFIRM [Q6] enabled, you will see a prompt after every UNDO / REDO operation that simply says "UNDO completed" (or "REDO completed" of course). You can close this by pressing OK on F6 or it will close automatically after a few seconds.

If there is nothing to undo / redo, the "Nothing to UNDO/REDO" prompt will inform you as such.

If you don't want these pop-up confirmations, simply disable the function.

In either of the PREFERENCES pages, the other function keys are:



EXIT [F1]	Returns you to the main SETUP page.
AUDIO SETUP [F3/4]	Takes you to a page where you can set audio I/Os operation.
CLOCK SETUP [F5/6]	Takes you to a page where you can set the real-time clock.

## AUDIO SETUP

If you select AUDIO SETUP [F3/F4], you will see this screen:

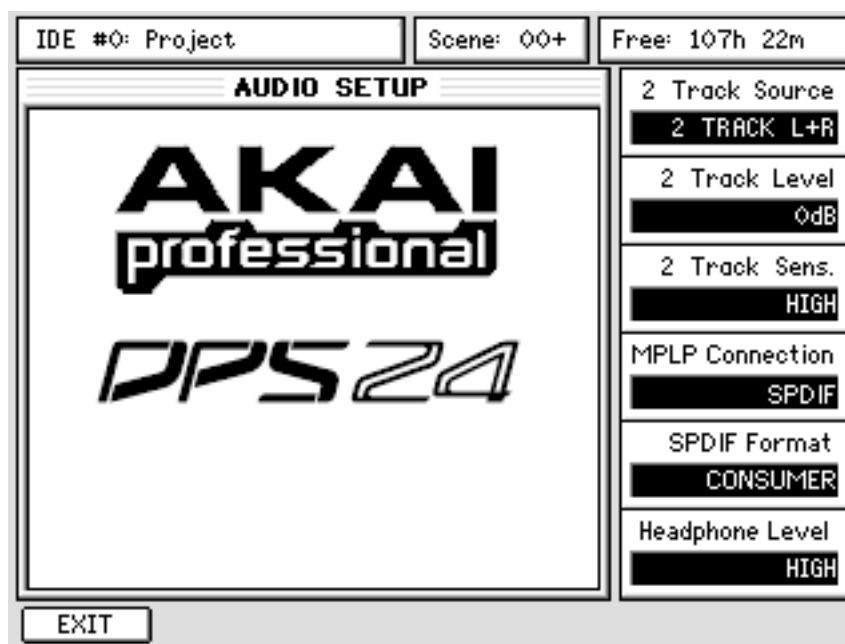

The parameters are:

**SOURCE [Q1]** Here you may select 2-TRACK L/R, DIGI IN L/R or AUX IN as the physical inputs for the 2-Track Source.

**LEVEL [Q2]** Here you can set the level of the incoming 2-track source.

**2-TRACK SENS [Q3]** Here you can set the input sensitivity of the 2-track source.

The options are:

**HIGH** Maximum input level is + 4dB

**LOW** Maximum input level is +13dB

**MPLP CONNECTION [Q4]** Here you can set the operation of the lightpipe I/O.

The MPLP (Multi-Purpose LightPipe - the optical connectors) can be switched between SPDIF (Stereo) or ADAT (8-Channel).

When MPLP is set to ADAT, the optical I/O connectors are both used for 8-channel ADAT signals (ADAT 1..8), while the RCA SPDIF I/O connectors are used for Stereo SPDIF signals (DIGI IN L/R and stereo DIGITAL OUTPUT).

However, when MPLP is set to SPDIF, the optical I/O connectors are both used for Stereo SPDIF signals (DIGI IN L/R and stereo DIGITAL OUTPUT).

In this case, the SPDIF Input RCA connector is disabled and the SPDIF Output RCA connector is used for Stereo SPDIF output (same signal as the optical output connector).

**SPDIF FORMAT [Q5]** Selects the stereo digital output format. The format can be switched between CONSUMER and PROFESSIONAL. Note that this affects the RCA phono output and the MPLP output when it is set to SPDIF.

As the name implies, CONSUMER should be used with 'consumer' products such as CD players, etc.. PROFESSIONAL should be used with more professional equipment that use the AES/EBU format of digital audio.

**NOTE:** The data stream for the PROFESSIONAL format is identical to that used on AES/EBU format digital audio connectors. However, more often than not, such connectors are balanced. You may need to make (or buy) a balanced jacl/XLR > phono cable or better, an adapter.

**NOTE:** It should be noted that the stereo SPDIF input of the DPS24 includes a real-time Sample Rate converter. It is therefore not required to lock the digital clocks of the DPS24 and of the Stereo Digital source. However, there is no sample rate converter on the ADAT inputs, and therefore, the digital clocks of the DPS24 and of the selected ADAT source should always be locked .

HEADPHONE LEVEL [Q6]      Here you can set the output level of the headphone outputs.  
The options are: HIGH, MID or LOW .

**NOTE:** The control by software of Headphone Level was not available on the very first production of DPS24. If you have such a unit, the Headphone Level option will not be displayed for Q6.

## CLOCK SETUP

Pressing CLOCK SETUP [F5/F6] in the PREFERENCES page shows this screen:

Using Q1-Q6, you can set the time and date of the real-time clock of the DPS24.

The new settings become active when you press SET CLOCK (F5/6).

You can return to the PREFS page by pressing EXIT [F1].

## USER BANK

Pressing U-BANK in the main SETUP page will show this screen:

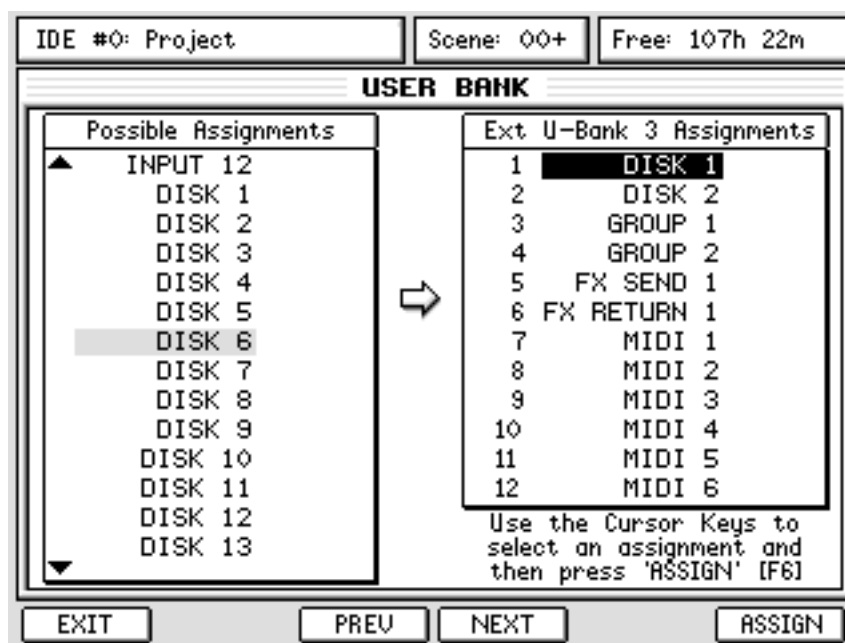

Here you can assign any channel to the 12 'user channels' of a User Bank.

This is useful as it allows you to have important channels conveniently available in one bank so that you have access to those channels quickly without having to switch banks all the time.

A User Bank can also be used for MIDI mixing of external sound modules, samplers, etc., and could also be set up to provide dedicated master FX/Aux sends which are not directly available on the panel.

The DPS24 has a total of five User Banks: the main User Bank, directly accessed via the dedicated USER BANK key, and four extra User Banks.

To access the extra fader banks, hold the SHIFT key while you press one of the first four FADER BANK keys. The USER BANK key will light up as well as the key pressed, to indicate that you have an extended user bank selected.

The PREV [F3] and NEXT [F4] keys in this page allow you to select which user bank you want to edit. The User Bank you are working on is shown in the title of the right hand column (in the example above, Extra User Bank 3's assignments are shown).

To assign a channel to a user channel, use CURSOR UP/DOWN or Q6 to move the cursor inside the left "Possible Assignments" column to the channel you want to assign.

Now press CURSOR RIGHT to move to the USER BANK ASSIGNMENTS column and use CURSOR UP/DOWN or Q6 to select the USER BANK channel.

Now press ASSIGN [F6].

Repeat as necessary for other channels.

**NOTE:** When an assignment is made, the left column cursor moves to the next channel and the right column cursor to the next fader, making it ready to assign.

Also, to select channels for assignment quickly, a shortcut is to press the appropriate channel's SELECT key on the front panel.

It is possible to assign the following to any given channel:

- INPUT 1-12
- TRACKS 1-24
- GROUPS 1/2 - 7/8 (\*)
- FX SEND 1-4 (\*)
- AUX SEND 1-4 (\*)
- FX RETURN 1-4
- AUX INPUT L/R (\*)
- MIDI CONTROLLER 1-16 (\*)

(\*) Pan, EQ and effects sends are not available on these channel assignments

The default assignments for the main USER BANK are:

- 1 FX SEND 1
- 2 FX SEND 2
- 3 FX SEND 3
- 4 FX SEND 4
- 5 AUX SEND 1
- 6 AUX SEND 2
- 7 AUX SEND 3
- 8 AUX SEND 4
- 9 AUX L/R
- 10 MIDI 1
- 11 MIDI 2
- 12 MIDI 3

You can return to the PREFS page by pressing EXIT [F1].

## OS UPDATE

Pressing SYSTEM / OS shows this screen:

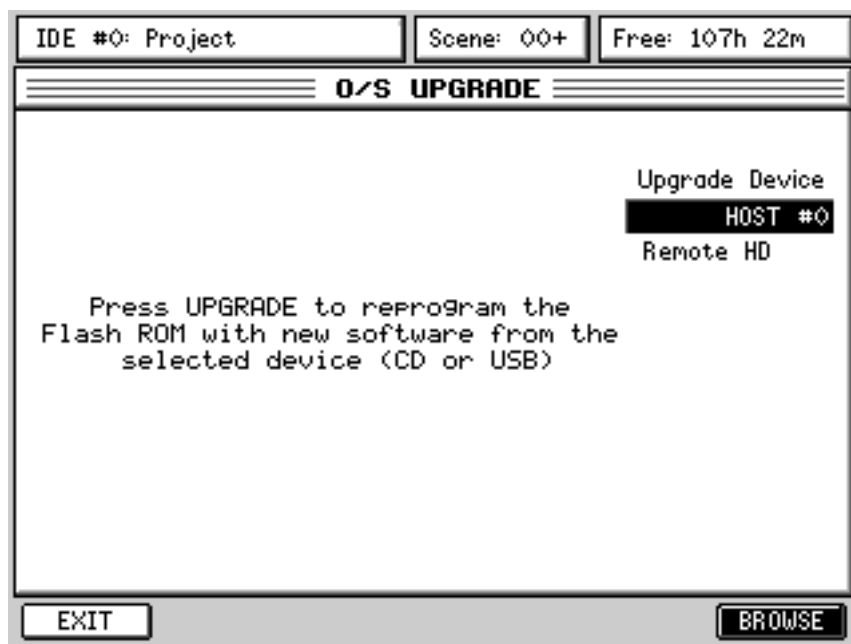



You can update the OS of the DPS24 from an ISO CD in the Internal CD drive (IDE#1).

However, you also have the option to update your DPS24 OS from any connected drive - any valid drives will show up in the Upgrade Device [Q2] field (including SCSI and HOST drives).

You have the option to browse the contents of the selected drive to select the OS you want to upgrade to.

Select the drive where your OS is stored and use BROWSE [F6] to navigate your way to it.

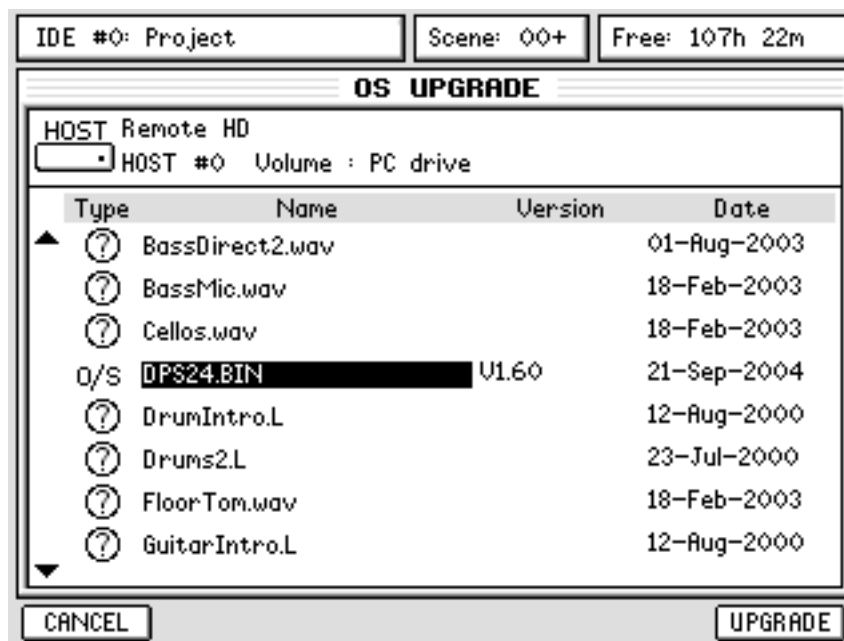

Once the OS file selected, press UPGRADE - the new OS will be loaded into the DPS24's FlashROM. You can also update the OS via USB using the free OS Loader utility software (for PC only, MS-DOS). In this case, set Upgrade Device field to USB and follow the step-by-step instructions found in the Appendix section.

However, please note that updating the OS via USB from a Windows PC or Macintosh OS X computer by using the free akSysServer utility and selecting a HOST drive in the Upgrade Device field is much more user-friendly than using the MS-DOS prompt.

**NOTE:** You can check the current O/S Version in the main SETUP page.

## DISK

Pressing DISK will show something like this screen:

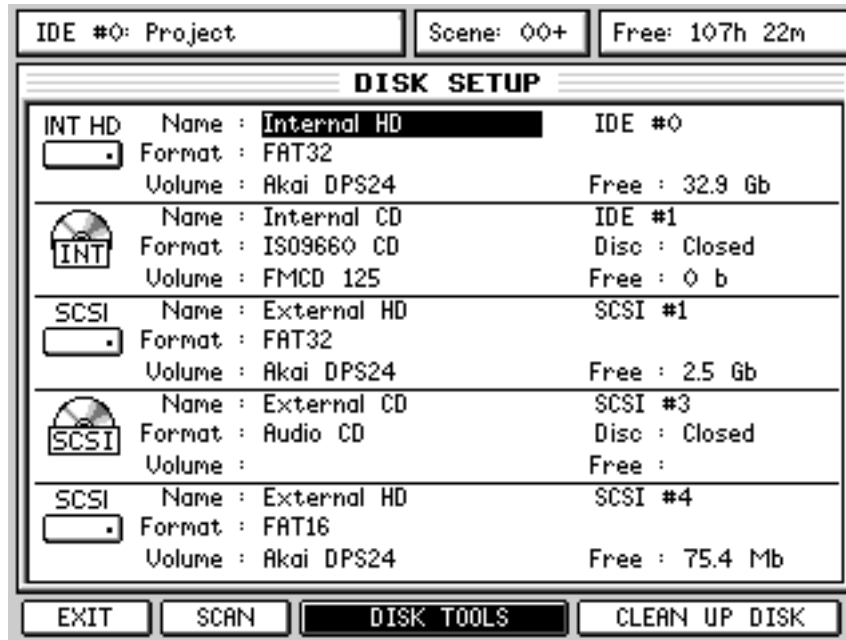

Here, you can see the list of drives connected to the DPS24, either internal IDE drives or external SCSI drives.

When the DPS24 is connected to a computer via USB and either akSys TrackView V1.21 or akSysServer are running, all the valid folder paths are shown in the DPS24 as additional HOST drives.

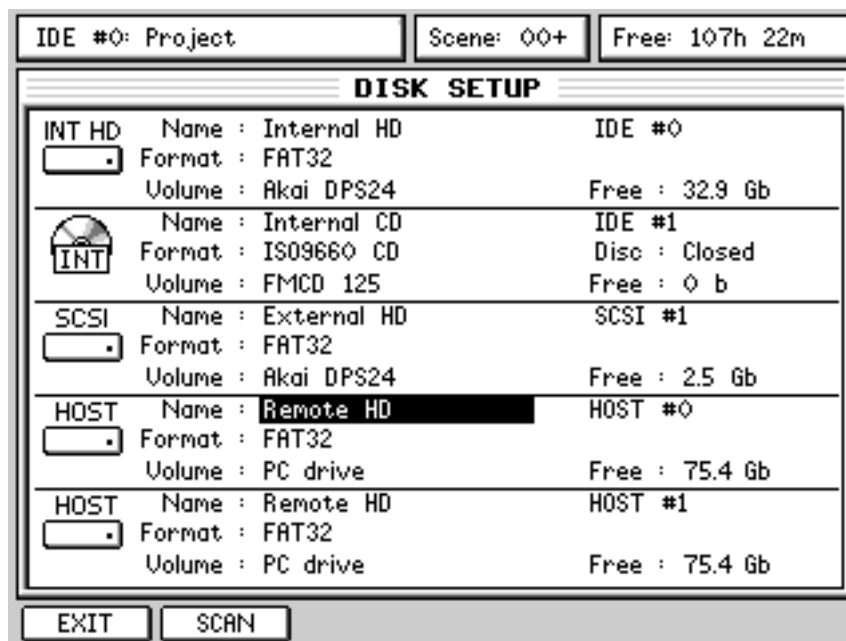

However, DISK TOOLS and CLEAN UP functions are not available for HOST drives. HOST drives are named as "Remote HD" and Free shows the size of the whole volume.

## CLEANUP DISK

The Cleanup Disk function allows you to clear your disk of 'orphaned' audio. A piece of audio can become orphaned when cues are deleted from a project. For example, you make a recording onto a track which appears as a cue. At some later date, you delete that cue - the cue has gone and the audio won't play but the audio is still on disk wasting disk space. Cleanup Disk will delete such audio off the disk thus freeing up space.

Cleanup Disk is found in the SETUP / DISK page on F5/6.

Pressing this will cause a pop-up to be issued confirming you want to proceed - assuming you do, you will see a progress display at the end of which, a prompt will tell you how many pieces of unused audio were deleted. If no items were deleted, you will be informed.

## DISK TOOLS

Pressing DISK TOOLS [F3/4] will show something like this screen:



Here, you can see more information regarding the selected drive, such as the drive's model number, its firmware version and its capacity.

The available Tools for a Hard Disk drive are FORMAT and AUDIO RECOVERY.

## DISK FORMAT

Pressing FORMAT [F6] will show this prompt:



FULL FORMAT [F2/3] will format the disk and will also perform a disk surface test checking for (and marking) bad blocks. It will erase all data from the drive. Depending on the size of your drive, this can take a long time.

QUICK FORMAT [F4/5] also formats the disk but because it does not do the lengthy surface test, it is relatively fast. It should only be done if the drive is known to be error free otherwise the DPS24 might try to use bad blocks on the disk.

If you are at all doubtful, a FULL FORMAT is recommended to prevent potential errors later on.

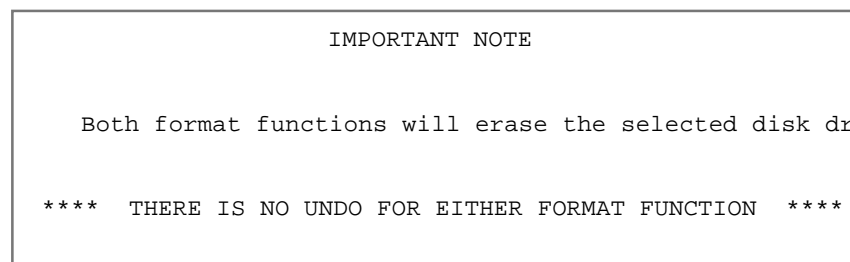

Pressing either format function will issue a further "ARE YOU SURE?" prompt. You should respond as appropriate but please proceed with caution. If you choose to format the selected drive, you will see a progress bar:

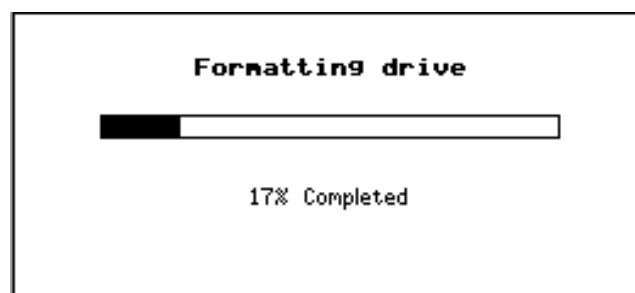

## AUDIO RECOVERY

When recording on the DPS24, audio is recorded to disk and what you see in the track display is a visual representation of pointers to that audio that tells the audio files when and where to playback. However, it is the 'pointers' that are edited when you are working and what's happening to the actual underlying audio data is of little consequence to you as a 'user'. Thus you can chop and copy and move and otherwise change and modify the pointers to the underlying audio in real-time without the tedious (and slow) process of actually having to move, delete or copy huge chunks of large audio files around.

However, there are certain occasions where you can delete a cue from the project and leave the actual audio files 'orphaned' (which can be deleted from the disk using the Disk Cleanup feature). Under normal circumstances, this wouldn't be a problem because you would simply hit UNDO. However.....

When a new project is created or another is loaded, the UNDO history is re-initialised. So, if, after deleting a cue, you were immediately to load a different project (or create a new one), you could not use UNDO to get the cue you deleted back and the audio it referred to would exist on disk but 'orphaned' from its pointers. This is a highly unusual scenario and unlikely to happen under normal circumstances. However, it could happen and so the AUDIO RECOVERY function allows you to overcome this.

This tool could also be used in a situation where, for instance, you would have deleted a Project by mistake.

Of course, in such circumstances, the Project has to be rebuilt take-by-take, and it could become a lengthy process if the project contained a lot of recordings.

However, this would be an extreme situation, but at least, the DPS24 would let you recover valuable takes that would have been lost otherwise.

This does not replace the necessity to backup your Projects on a regular basis.

Pressing AUDIO RECOVERY [F5/F6] in the DISK TOOLS page will show this screen:



As in WAV Import, the DATE RANGE parameter allows you to narrow down the number of files you will view when you press the BROWSE key [F6]. The options are the same as for the WAV IMPORT function.

If you want to recover all 'orphaned' audio, select ALL. However, if your problem occurred a few days ago, you can specify PAST WEEK or if it only just happened a few minutes ago, you could specify TODAY.

Pressing BROWSE will show something like the following.

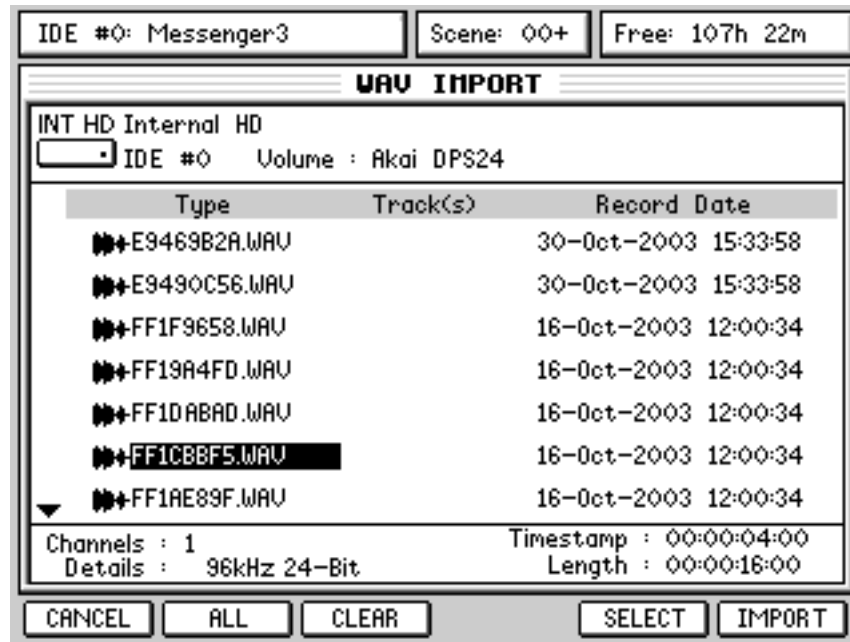

You can see that the filenames are - shall we say - somewhat obscure! However, you should be able to decide which files you want / need to recover from the date / time shown to the right of the display.

## PERFORMING AN AUDIO RECOVERY

We are going to assume the following scenario.....

You have just recorded a guitar part on Track 6 of the project NEW SONG 3 but you don't think it's very good so you delete it. You want to listen to a guitar part you recorded in another project for a guideline or for some inspiration or whatever so you load that project. You listen to that guitar part and think that maybe the one you just recorded in NEW SONG 3 wasn't so bad after all. You then go back to NEW SONG 3 but..... oooops! The guitar part you just recorded is not there (you deleted it). However, because loading the other project wiped the UNDO history, you can't undo the deletion either. Panic sets in!!! Don't worry... all is not lost if you follow these ten simple steps:

- 1 With NEW SONG 3 loaded, press EDIT and select Track 6 for edit.
- 2 Press SETUP
- 3 Press DISK
- 4 Press DISK TOOLS
- 5 Press AUDIO RECOVERY
- 6 Select TODAY as the DATE RANGE
- 7 Press BROWSE
- 8 You will see the 'orphaned' audio file
- 9 Select that file by pressing SELECT [F5]
- 10 Press IMPORT and enable TO TIMESTAMP when prompted.

You're done!

Now press MAIN.... you will see the guitar part you thought you had lost has been re-instated safely on Track 6!

Please note that when using audio recovery, the files are not actually copied (unless they are sample rate converted), so you do not lose any disk space.

VERY IMPORTANT NOTE

\*\*\* AUDIO RECOVERY is not possible after performing DISK CLEANUP \*\*\*

# CD-RECORDER

The SETUP key's SHIFT function is CD-R and shows you this screen:

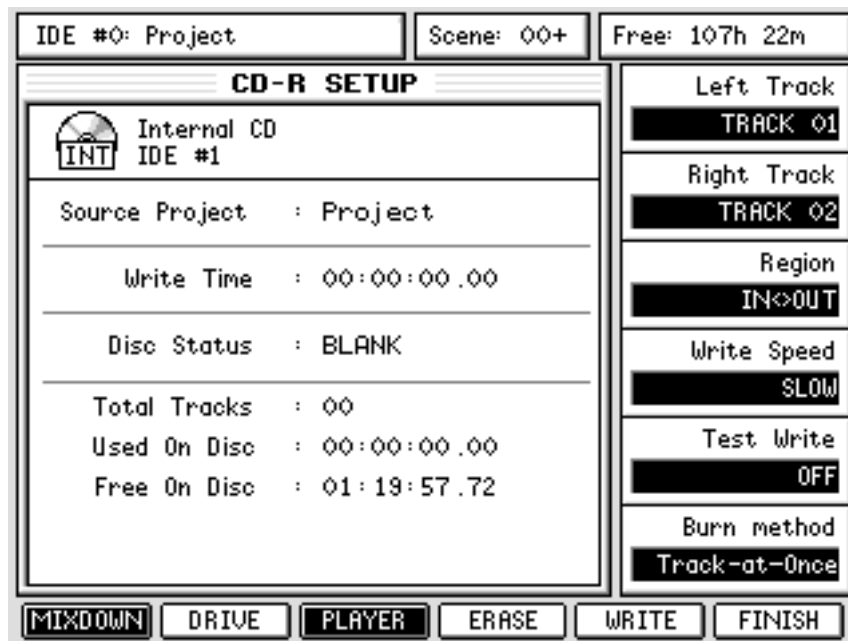

This page provides access to all the functions related to Audio CD creation.

The large window on the left shows general information. None of the parameters are editable but are:

CD DRIVE	Shows the selected CDR Drive
SOURCE PROJECT	Shows the currently selected project. To select another to record to CD, load the appropriate project in the PROJECT mode.
WRITE TIME	Shows how long it will take to record the selected region to CD. The Write Time is only shown if a valid CDR (Blank or Unfinished) is inserted in the drive.
DISC STATUS	NO DISK appears if no disc is inserted in the drive. BLANK appears if a Blank CDR is inserted in the drive NOT FINISHED appears if the Finish process has not been performed. FINISHED appears if the Finish process has already been performed. DATA DISK appears if an ISO Data CD is inserted in the drive.
TOTAL TRACKS	Displays the total number of tracks on the CD.
USED ON DISC	Indicates the total time recorded on the CD.
FREE ON DISC	Indicates the total time free for recording on the CD. The Free On Disc Time is only shown if a valid CDR (Blank or Unfinished) is inserted in the drive.

To the right are parameters that can be adjusted using the Q-Link controls. They are:

LEFT TRACK	Selects which track of the source project will be recorded as the left track on the CD. You may select any disk track 1-24.
RIGHT TRACK	Selects which track of the source project will be recorded as the right track on the CD. You may select any disk track 1-24.



REGION	Selects which portion of the selected tracks will be recorded to the CD-R/CD-RW. The options are IN/OUT or ALL.
WRITE SPEED	Specify the writing speed here. You may select SLOW or FAST. SLOW writes at normal (real-time) speed. FAST, however, does not necessarily write at the CD-RW/CD-R's fastest speed but at the highest mutually compatible speed. This is likely to be slower than the CD's fastest possible speed (e.g. if you have a 24x speed writer, the FAST setting might only write at 4x speed).
TEST WRITE	This allows you to select whether or not to perform test writing. Test write is a process in which a weak laser is projected onto the disc surface to check whether any malfunctions will occur during data transfer. If you have not written data to discs at all or have only done so a few times, perform the test write process.
BURN METHOD	This allows you to select TRACK-AT-ONCE or DISK-AT-ONCE. With 'track-at-once', you can write individual 'tracks' one-by-one. You can keep adding 'track's to the CD until you finalize it with the FINISH function. With 'disk-at-once', you can write an entire CD and finish it in one pass.

The soft key functions are:

MIXDOWN [F1]	Takes you to a page where you can create a stereo mixdown suitable for writing to CD-R.
--------------	---

**NOTE:** It is not possible to mixdown a multitrack project directly to CD-RW/CD-R. To do this, you should first use the MIXDOWN function to create a stereo mixdown and then burn that stereo mix to CD. This process is described on the following pages.

DRIVE [F2]	Allows you to select the CD-R drive (Internal or External)
PLAYER [F3]	Takes you to the CD PLAYER page.
ERASE [F4]	Allows you to erase a CD-RW media for re-use. Pressing this pops up an "ARE YOU SURE?" prompt to which you should respond accordingly. Of course, you cannot erase a CD-R media.
WRITE [F5]	Initiates the Track-at-once writing process. If Disk-at-once is selected, F5/F6 keys are replaced by "WRITE CD". Pressing this pops up an "ARE YOU SURE?" prompt..
FINISH [F6]	This option is only available when using the 'track-at-once' method. The Finish process is a process of writing readout information to a disc. This allows you to complete a CD-R/CD-RW so that it can be played on a compatible audio CD player. Once a disc is 'Finished', it is not possible to add more 'tracks' to it. Pressing this key puts up an "ARE YOU SURE?" prompt.

**NOTE:** It is not possible write to CDR a project with a sample rate other than 44.1kHz. Therefore, if the current project is at a different sample rate, F5/F6 keys are replaced by "CONVERT TO 44.1kHz". This process is described on the following pages.

## DOWNSAMPLING PROJECTS FOR CD MASTERING

If you have made projects at sample rates other than 44.1kHz and/or you have projects which contain recordings made at bit-depths other than 16-bit which you want to master onto CD, you will need to convert them to 44.1kHz/16-bit.

Pressing CD-R (SHIFT+SETUP) will show this screen:

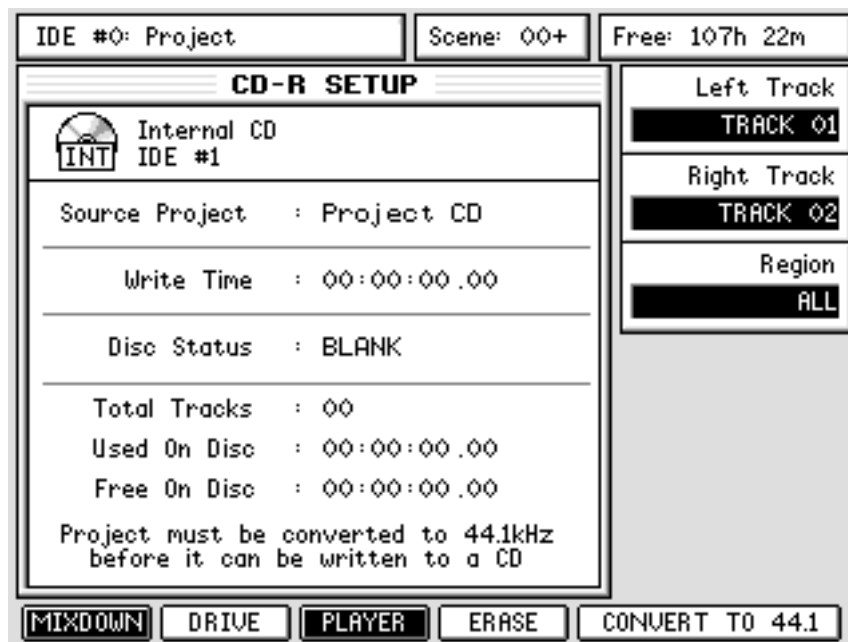

CONVERT TO 44.1 allows you to convert a project recorded at any sample rate and with recordings of any bit-depth to 44.1kHz/16-bit suitable for CD mastering.

First select the project you want to convert in the usual way from the PROJECT page. In the CD-R SETUP page, pressing F5/6 will pop-up a prompt asking you to confirm that you want to convert the currently selected project into 44.1kHz/16-bit. Respond accordingly. If you respond YES, you will see the usual naming prompt where you may enter a name for your new project. As the project is being converted, you will see a progress display. You can abort the process at any time.

After the process is complete, you will have a 44.1kHz/16-bit project that will be suitable for mastering onto audio CD.

When you perform the conversion, the project is re-sampled at 44.1kHz and is dithered down to 16-bit using TPDF (triangular probability density function), a well known dithering algorithm that ensures high quality bit reduction with few audible artefacts.

### **NOTES REGARDING CONVERTING DOWN TO 44.1KHZ/16-BIT**

*You don't have to perform this conversion unless you are mastering projects made at sample rates other than 44.1kHz and/or which contain recordings made at bit-depths other than 16-bit to CD.*

*You can create mixdowns in your chosen sample rates and bit-depths to use as stereo masters.*

*However, in order to produce a master audio CD, you will need to run these mixes through the conversion process.*

*Of course, if your project is recorded at 44.1kHz and contains only 16-bit recordings, the conversion process is not necessary.*

## HOW TO PREPARE MATERIAL FOR DISK-AT-ONCE

Assuming you have mixed down all the stereo masters you want to put on your CD, create a project and, using copy and insert, create your 'playlist' so that all the songs you want to put on the CD are placed end to end thus:

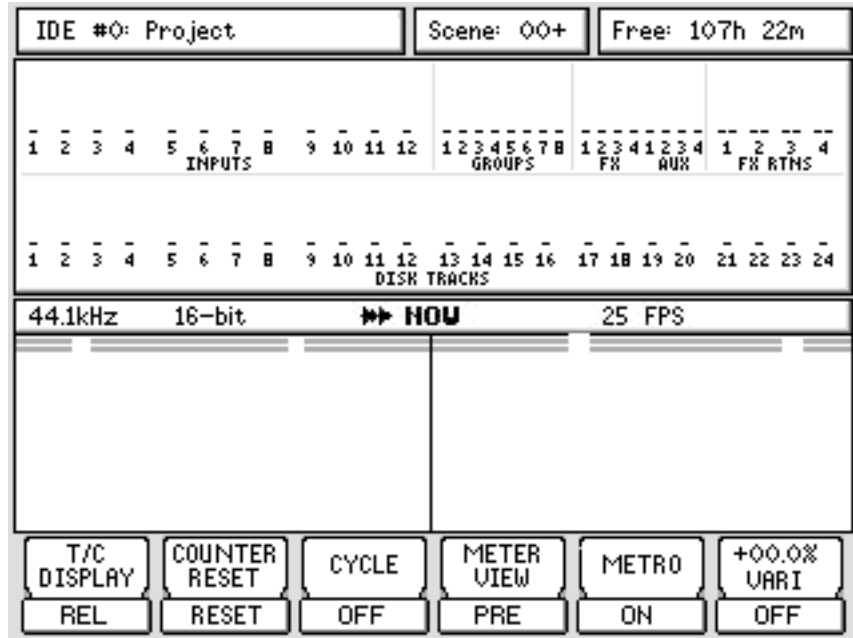

You could just make your CD from this. However, you will probably want to put track markers on your CD. This is done using the autolocator. At the start of each track, mark an autolocate point and give each locator memory names such as shown below:

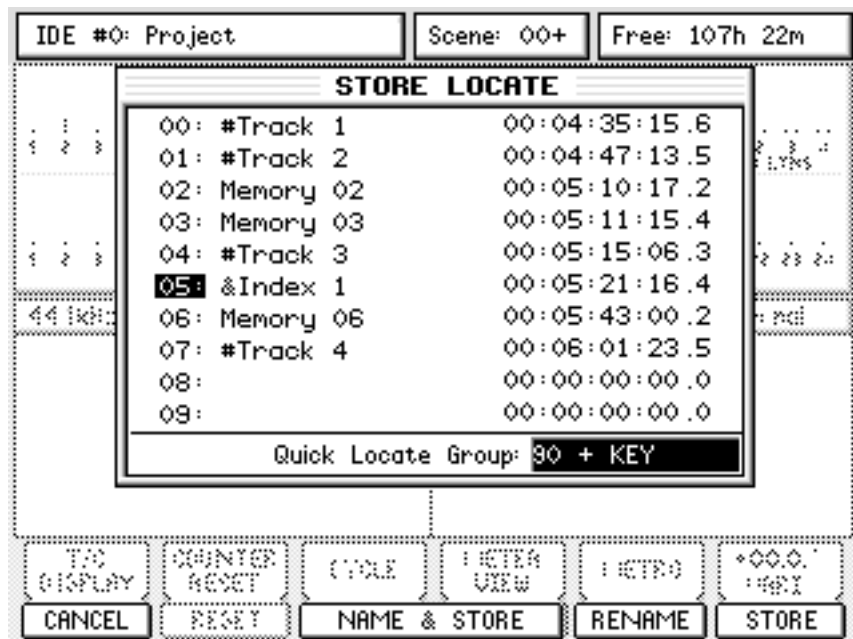

Those locate points that are prefixed with # will register as track marker points on the CD.

Even if your CD is made up of one long piece of music, you can place track markers at points throughout the piece. For example, if you have done a remake of the 25 minute opus 'Supper's Ready' by Genesis, each 'section' can have track markers. Alternatively....

If you want, you can also mark 'indexes'. These can be used to locate to positions within a track (for example, intro, verse 1, chorus 1, verse 2, chorus 2, instrumental, final chorus or whatever).

To mark an index, the locate point should be prefixed with an ampersand (&).

**NOTE 1:** Marking indexes is optional. Some CD players don't actually have the ability to locate to indexes so it's entirely up to you if you want to use them.

**NOTE 2:** Autolocate points that are not prefixed with either # or & will be ignored (locate memories 2, 3 and 6 in the example shown on the previous page).

**NOTE 3:** The locators used for Track IDs and Indexes must be stored in ascending order for correct operation.

**NOTE 4:** The minimum time between two Track IDs is 4 seconds.

Once you have set up your track markers, you can proceed to the CD-R page. Set the parameters as follows:

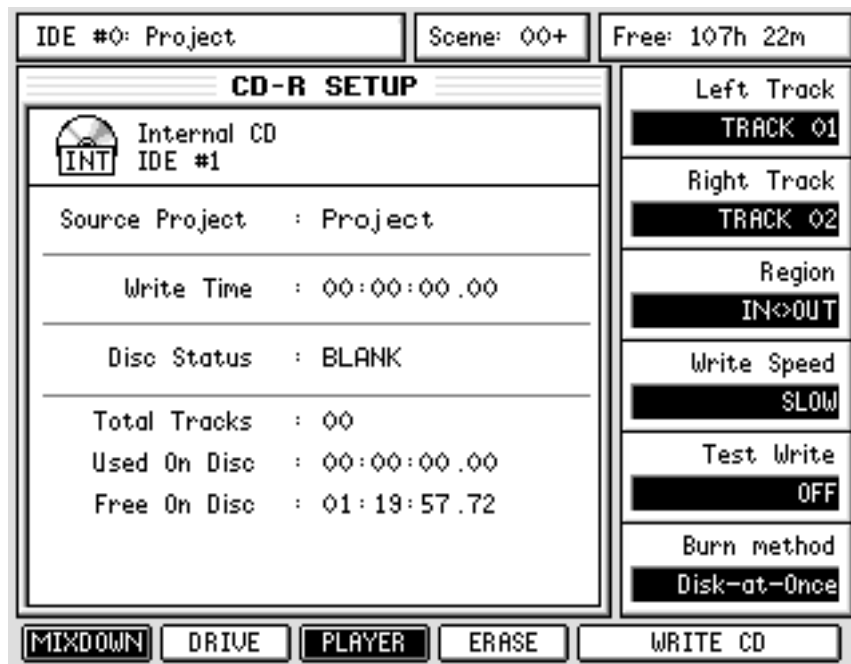

Assuming you have a blank CD-R inserted in the drive, press WRITE CD. You will be asked if you want to proceed to which you should respond as appropriate. If you choose to proceed, you will see a progress display as the audio CD is created. At the end, you will have a finished audio CD, complete with track markers to play in any audio CD player.

The advantages of DISK-AT-ONCE is that you can create your own playlist and specify the gaps between the various tracks and also where the track markers and indexes will be placed. Plus, of course, you can just let the thing run and create your final CD in one pass.

**NOTE:** Not all CD-R drives support Disk-at-once operation. If you have an old CD-R drive, this feature might not be working properly.

## MIXING DOWN

It is not possible to mixdown a multitrack project directly to CD-R so first, you should make a stereo mix to the DPS24's 'virtual 2-track recorder'. This is done in the MIXDOWN page:

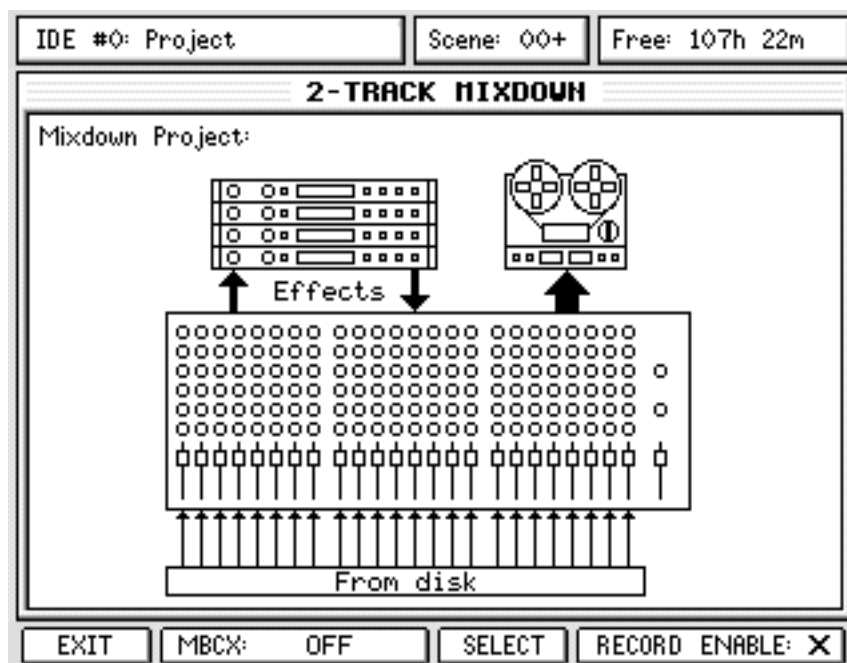

The graphic in the window represents what is happening - you are mixing down up to 24 channels of disk tracks to a 2-track machine and you can use the four effects channels. What isn't shown is that it is also possible to mix external inputs during the mix process and also that channels may be sub-grouped to the L/R bus for sub-mixing.

To make a mixdown, first select the completed project you want to mixdown and locate to its start. Now, in the MIXDOWN page, press SELECT [F4] or press REC ENABLE [F5/6], create a new project using NEW [F5] and enter a name for your stereo mixdown file. By default, the DPS24 will use the current project's name with the suffix "Mix" appended to the end of the name. You can also select an existing project to mixdown to, however, this project will be overwritten.

You are now set up to mixdown. To confirm, "Mix-down via Effects" is displayed at the top of the LCD screen as long as the DPS24 is in Mixdown mode.

Press PLAY and RECORD to record your stereo master mixdown. At the end of the mixdown, drop out of record in the usual way. You can also use AUTO-punch to start and stop recording automatically between the IN and OUT markers.

After recording, in the PROJECT mode, you will see your new mixed project listed in amongst the rest. Select and load that project. What you will see is a 24-track project that uses just tracks 1 and 2 which contain your stereo mixdown (left channel on track 1; right channel on track 2). To record this to CD-R, in the CD-R page described on the previous pages, you should select TRACK1 for the LEFT TRACK and TRACK 2 for RIGHT TRACK. Now press WRITE - your stereo mix will be written to the CD.

This method may seem convoluted but there are good reasons for it. Firstly, it allows you to try several different mixes of each project before committing to CD. Also, it allows you to edit the master mixdown in the usual way just like any multi-track project.

For convenience, the MIXDOWN page is also available in the Master Channel page as well as the CD-R page.

## MULTI-BAND COMPRESSOR/EXPANDER

Included in the DPS24 is a multi-band compressor/expander (MBCX) that can be used to improve stereo mixes before writing to CD.

The algorithm used is identical to that released in our QuadComp VST plug-in.

Whilst it is possible to use an ordinary compressor for tightening up and adding punch to a stereo mix, it is very common that low frequencies can cause 'pumping' effects on the overall signal. Alternatively, high frequency sounds such as cymbal smashes can have an adverse affect on the overall sound. However, by splitting the signal into four different frequency bands, each frequency can be separately processed.

This is achieved on the QUADCOMP MBCX using a series of crossover filters. These filters are constructed as linear phase FIR filters in order to produce a signal path which is perfectly free of phase errors.

When MBCX is enabled (either PRE FADER or POST FADER) in the MIXDOWN page, the four internal effects processors are replaced by the MBCX.

Therefore, pressing the FX key takes you to the MBCX page that looks like this:

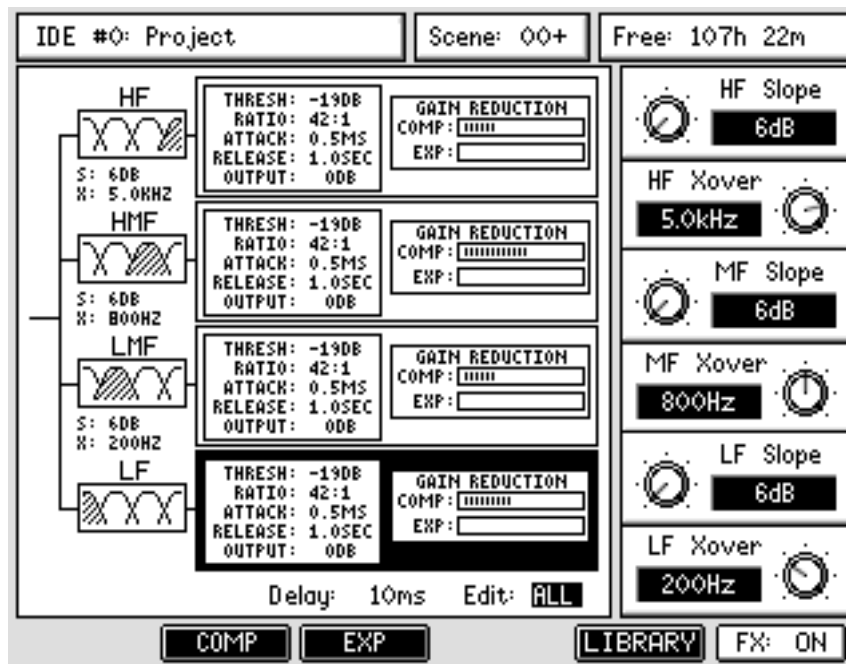

The first page allows you to set the crossover frequencies for each of the bands. These are set in the various "XOVER" fields. The frequencies available are 50Hz, 80Hz, 125Hz, 200Hz, 320Hz, 500Hz, 800Hz, 1.25kHz, 2kHz, 3.2kHz, 5.0kHz, 8kHz and 12kHz.

**NOTE:** One frequency cannot be set higher or lower than the adjacent band. For example if the MF XOVER is set to 800Hz as shown above, LF cannot be set higher than that and you will be able to set 50Hz, 80Hz, 125Hz, 200Hz, 320Hz, 500Hz for the LF. Similarly, in this example, the MF XOVER cannot be set lower than 200Hz.

The four frequency bands also have a variable slope and these can be set to 6dB, 12dB, 18dB and 24dB per octave.

The MBCX has a Library of presets that can be accessed using F5. In the Library page, you can store your own presets if you want.

It is possible to bypass the MBCX using F6.

Pressing the COMP button on F2 will show this screen:

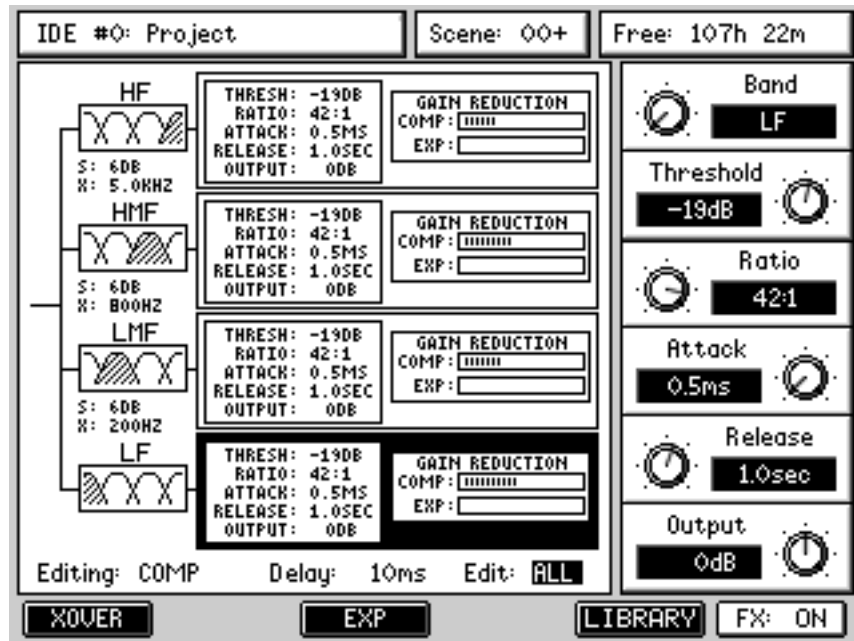

Each band (LF, LM, HM, HF) is selected using Q1. As you select each band, it is highlighted in the window to the left:

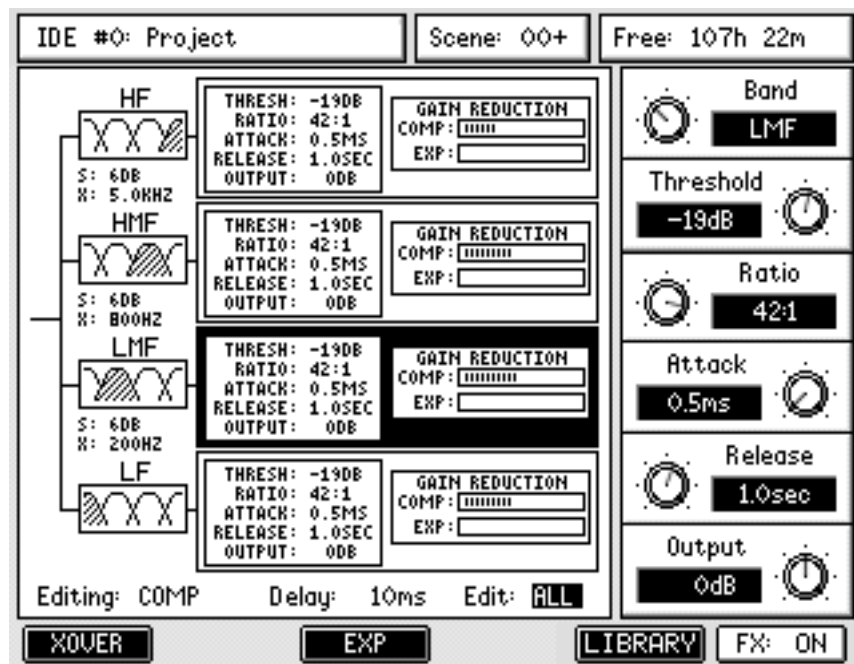

In this way, it is clear to see which band of the compressor you are editing.

The compressor and expander have almost identical controls. These are:

- BAND Selects the frequency band.
- THRESHOLD Sets the level at which the processors have an effect. The results are different for the compressor and the expander. For the compressor, the threshold sets the level at which compression takes place. Signals above the threshold will be compressed but signals below this level pass through the compressor unaffected. For the expander, the logic is the other way round - signals above the threshold are not affected but signals below the threshold are brought up in level according to the settings of the controls below. By using the two together, it is possible to create a 'componder' - i.e. signals above the threshold are reduced in level (compressor) and signals below the threshold are brought up in level (expander) as this simple example demonstrates:

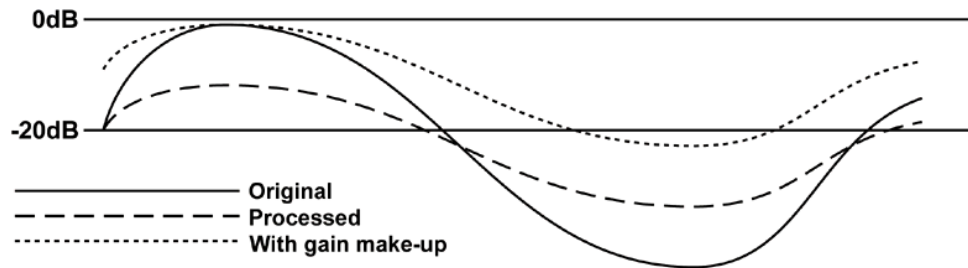

The incoming signal level has a huge dynamic range going from very loud to very quiet. By setting the compressor and expander thresholds to the same value, the output of the processor will be the signal shown with the dashed line - as you can see, its dynamic range is now much more even. However, because the loud signal is now reduced in level quite dramatically, the overall signal level can be pushed up (shown with the dotted line). This gives the effect of the whole thing sounding a lot 'louder' or 'bigger' and the fact that you can control each frequency band separately gives you a great deal of control.

However, because you have completely separate control of the compressor and the expander's threshold, it is possible to set the processor so that loud signals are compressed and quiet signals are expanded as above but it is possible to leave a portion of the signal unaffected by either compression or expansion:

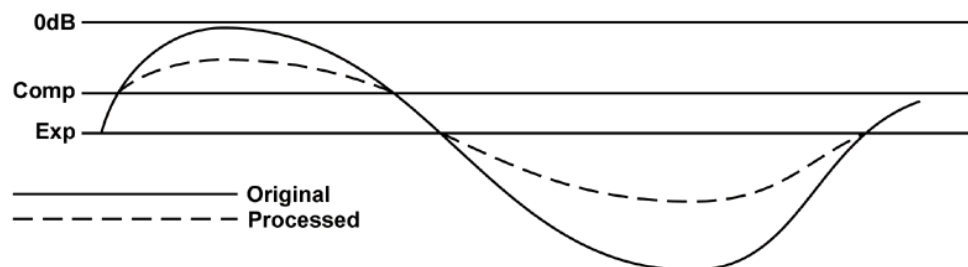

In this example, the portion of signal between the compressor's threshold and the expander's is unaffected.



Another way to look at the relationship between the two is thus:

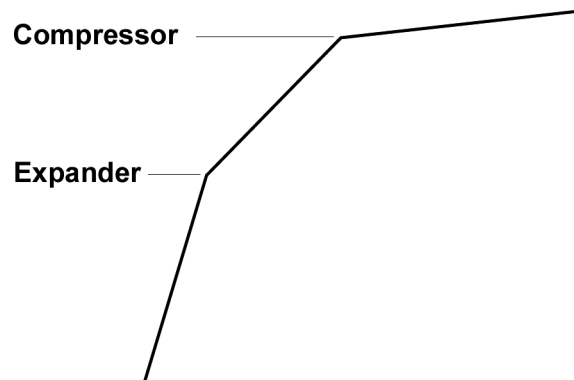

**NOTE:** The compressor's threshold cannot be set below the expander's. Likewise, the expander's threshold cannot be set above the compressor's.

**RATIO** Sets the ratio for the compressor or the expander.

**NOTE:** For the expander, a ratio of *-INF* means that the expander is effectively disabled.

**ATTACK** Sets the time it takes before the audio is processed.

**RELEASE** Sets the time it takes for the audio processing to finish.

**OUTPUT** Makes up for any gain reduction that may occur in the process.

Other controls that affect the MBCX 'globally' are found in the left hand window and are accessed using the CURSOR < / > keys. These are:

**DELAY** This parameter allows the MBCX to 'predict' the signal that is coming (in other words, the effect is delayed). What this means in practice is that if a signal is coming that has a very large transient, the MBCX will be ready for it so that when it arrives at the MBCX's input, the transient won't 'overshoot' and cause potential distortion. To set this up, listen to the track you are mastering - if you detect any 'overshoot', adjust the delay time until the problem is eliminated.

**EDIT : ONE/ALL** Normally, you edit each frequency band individually but, with ALL selected, you can control all four bands simultaneously.

## LOADING/SAVING MBCX PRESETS

Several preset MBCX configurations are provided that cover a wide range of applications. These can be selected by pressing LIBRARY (F5) in the MBCX page. This will take you to a page where you can select the presets. Move to the preset you want to use and press RECALL (F3).

In this page, you can also store your own presets simply by pressing STORE (F4). You will see a naming prompt - enter an appropriate name and press OK.

### **NOTES REGARDING THE MBCX**

- When the MBCX is being used, it utilises all the effects DSP's processing. In short, you cannot use the four channels of effects when the MBCX is enabled. To return to the normal effects, you should press CD-R, MIXDOWN and switch MBCX off using F2/3.

- When the MBCX is enabled, it is inserted into the L/R mix bus. It can be inserted pre-fade or post-fade.

When using the MBCX as a 'compander' to regulate overall dynamics, it is best to insert it pre-fade. This is because when being used in this way, the MBCX's processing relies on levels to operate properly. If the MBCX were to be inserted post-fade and you were to perform a fade out on the master fader, as the level drops so the action of the MBCX on the signal. As such, in this case it is best to insert it pre-fade so that the MBCX is always receiving the full level of the stereo mix bus.

However, when using the MBCX as a limiter (compressor ratio set to maximum), it is best to insert it post-fade.

- When adjusting parameters on the MBCX, as with other static controls, be sure to either save your work as a preset (see above) or store Scene 00 before re-commencing playback. Alternatively, switch the automation off.

Scene 00 holds the initial state of the mixer for the project and is recalled whenever a project is loaded or an automation pass is started. This means that when the dynamic automation is ON, scene 00 will be automatically recalled whenever PLAY is pressed to ensure that all the controls, including those which are not dynamically automated, are set to the correct value in relation to the current playback time. It is therefore important to ensure that you store the required mixer state to scene 00 before starting to use the dynamic automation and update it whenever you want to change the initial state of a control during automation playback.

So, a possible scenario is: you are playing your mix and adjusting the MBCX and the track finishes. You locate to the start of the track, press PLAY and.....

Your MBCX settings are all lost and Scene 00 re-initialises the static controls to their previously stored state.

Of course, this is also true for all static controls.

## MASTERING ON THE DPS24

Although it is possible to use the MBCX when mixing down your 24-track project, you lose the possibility of using the internal effects.

Therefore, the best way to master your recordings using the MBCX is to first perform a stereo mixdown as normal (i.e. multitrack mixdown via effects to the DPS24's 'virtual' 2-track).

Assuming you are happy with the mix and want to 'master' it through the MBCX, you should then load your 2-track mix project in the usual way from the PROJECT page and proceed as follows:

- 1 Press CD-R (SHIFT+SETUP)
- 2 Press MIXDOWN (F1)
- 3 Enable the MBCX using F2/3. The MBCX can be off, pre-fader or post-fader and this can be selected by pressing F2/3 repeatedly. When the MBCX is enabled, the graphic changes to show the MBCX:

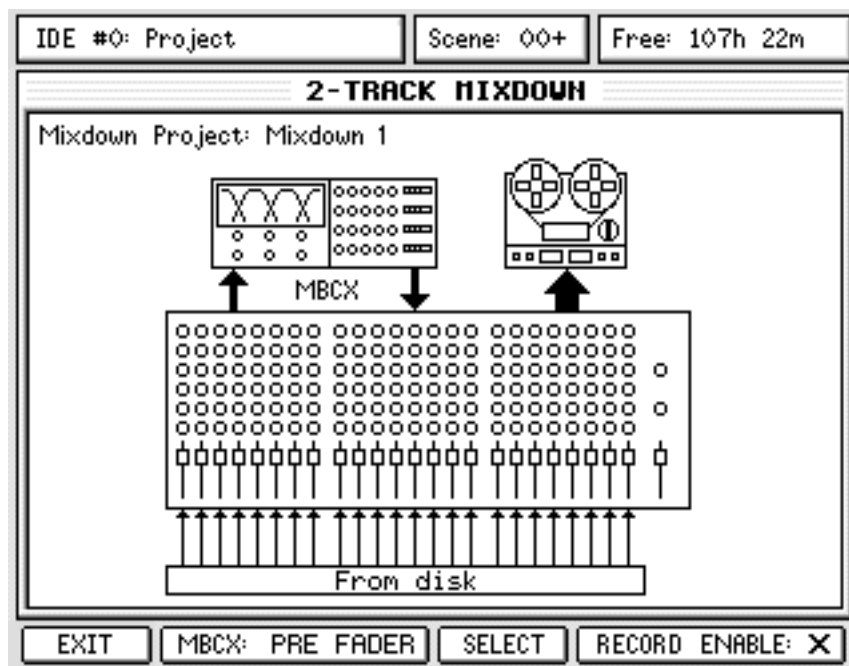

- 4 Press PLAY in the transport controls to playback your stereo mix
- 5 Press FX - the MBCX parameters will be displayed and you can adjust these as the track is playing.
- 6 Once you are happy with the settings of the MBCX and the sound of your mix, go to the CD-R page again and press RECORD ENABLE.  
("Mix-down vis Multi-Band Compressor" will then be displayed at the top of the LCD screen as a reminder)

- 7 Now press SELECT - this will take you to the this page:

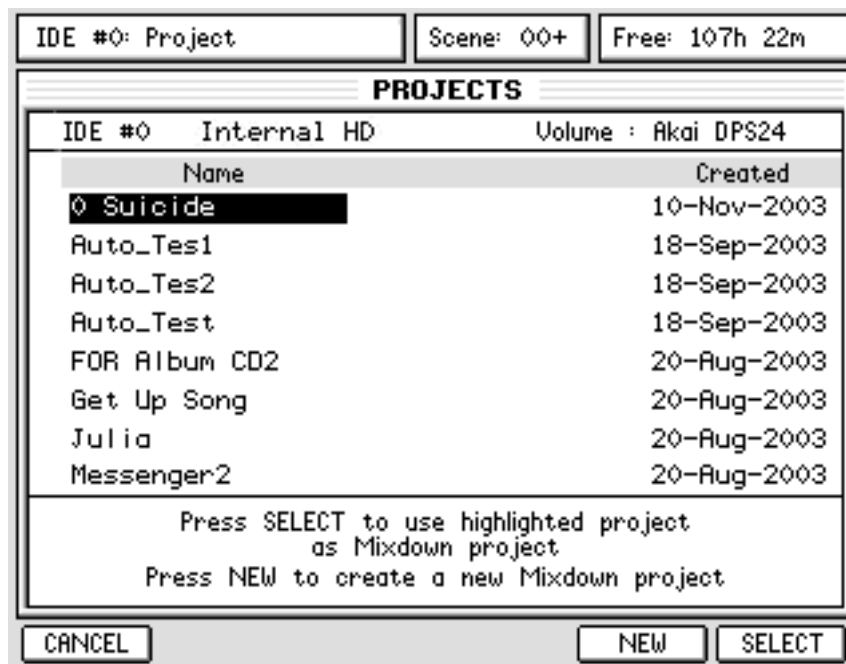

Here you can either select a project you want to overwrite (for example, a stereo mix you made previously which you are not happy with) or you can press NEW to create a new mixdown project. Either way, you will automatically be taken to the MAIN screen.

- 8 Press the PLAY+REC transport controls - your stereo mix will be 'mastered' via the MBCX.

**IMPORTANT NOTE REGARDING SCENE 00 AND THE MBCX**

*When you first load your stereo mix project, it is likely that it will have the internal effects selected in Scene 00. Even though you may enable the MBCX as described in Step #3 on the previous page, when you commence playback, it may switch over to the internal effects (because this is what is stored in Scene 00).*

*To overcome this, when you select the MBCX in Step #3, store Scene 00 - this will store the MBCX selection in the initial scene.*

*Alternatively, just switch automation off.*

**NOTE:** *If the project sample rate is not 44.1kHz, converting to 44.1kHz should be the last step before writing to CD.*

**NOTE:** *It is also possible to use the NORMALISE DSP feature in order to maximize the levels of the final mix before writing it to CD.*

## CD PLAYER

Pressing CD PLAYER (F1/2) shows this screen:

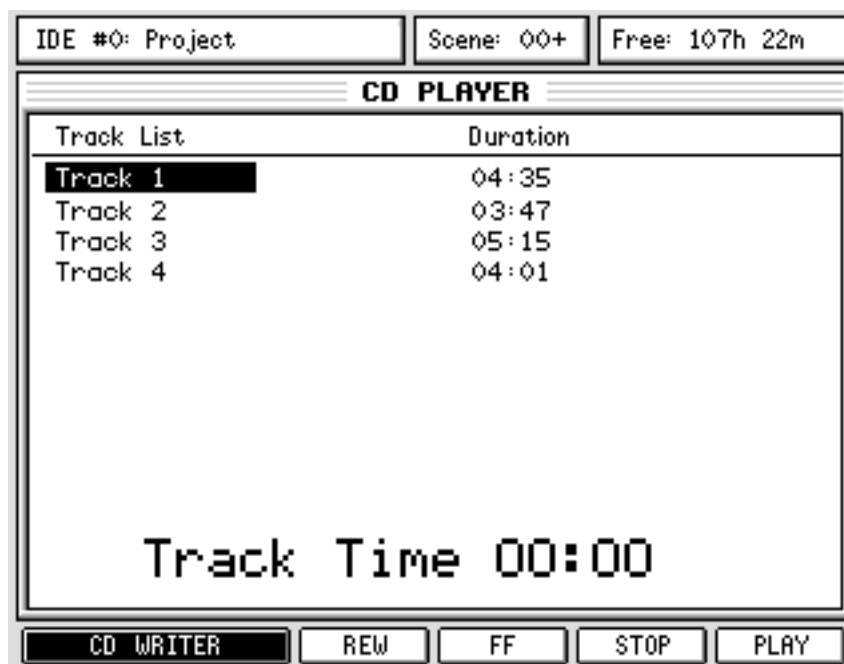

Here you can play tracks recorded on the CD-R/CD-RW using a simple user interface.

Use the CURSOR UP/DOWN keys to select a track to play and use the CD player's 'transport' keys on F3-F6 to play, stop, pause or rewind/fast forward through tracks on the CD.

When a track is playing, you can skip to the next using the CURSOR UP/DOWN keys which will cause playback to skip to the next track. During playback, you can use the rewind and fast forward keys to 'stutter' through a track.

When a track is playing, the status of F6 changes slightly:

- PLAY      When idle, F6 is a 'play' key.
- PAUSE     During playback, F6 becomes a pause control.

**NOTE:** It is not possible to play the CD through the DPS24's monitoring system. You can listen to it on the CD-RW's headphone socket (if the model installed has one, of course) but, ideally, to hear the CD you have created, you should take it to a compatible CD player.

You can return to the CD-WRITER at any time by pressing F1/2 [CD WRITER].

It is also possible to PLAY the Audio Tracks of an unfinished CD.

## EXT SYNC KEY

To synchronise the DPS24 with external devices, the EXT SYNC key should be pressed:

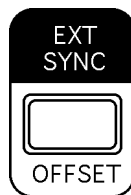

This key enables the Time Sync [Q4] and T/C rate [Q3] selections made in the SETUP page:



If Time Sync is set to MTC MASTER or MIDI CLOCK OUT, the DPS24 will now generate MTC or MIDI CLOCK during playback.

If it is set to MTC SLAVE or SMPTE SLAVE, the DPS24 will now only play upon reception of external timecode. (unless the optional IB-24LTC SMPTE board is fitted, MTC SLAVE is the only source for external MTC).

While the DPS24 is waiting for external time code, the LED of the PLAY key flashes.

In addition, the type of Time Sync source is displayed to the right of the Project info bar in the MAIN SCREEN when the EXT SYNC key is enabled:



Also, the EXT SYNC key enables the MMC MASTER/SLAVE operation set in the SETUP / MMC page.

**NOTE:** When EXT. SYNC is disabled, the Time Sync and MMC settings are ignored (same as Time Sync OFF and MMC OFF)

## SETTING EXT SYNC OFFSETS

Pressing SHIFT+EXT SYNC allows you to set a timecode offset. This prompt appears on the LCD:

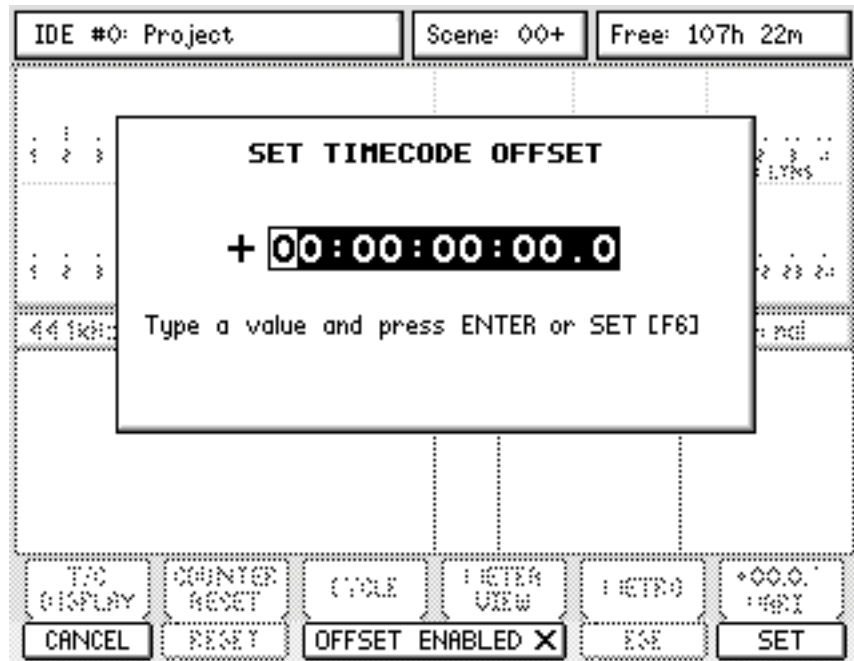

The first digit is highlighted and you should enter a value from the numeric keypad as appropriate.

To set the 'sign' (i.e. + or -), move the cursor to the sign and press '+' or '-' on the numeric keypad as appropriate. Once an offset has been entered, press ENTER or SET [F6].

Then, use F3/F4 to enable/disable the offset.

## INTEGRATING ADAT™ MACHINES

The optional IB-24ADT ADAT board adds a further 16 ADAT inputs and outputs to the standard 8 inputs/outputs giving a total of 24 ADAT inputs and outputs.

The option board also features an ADAT SYNC connector allowing you to integrate ADAT machines into your DPS24 studio setup.

The ADATs can be used simply for transferring 'legacy' material from your ADAT(s) to the DPS24 or for transferring projects created on the DPS24 to ADAT machines.

With the ADAT board installed, simply connect your ADAT machines to the optical connections.

ADAT #1 (i.e. the one you regard as being tracks 1-8) should be connected to the internal ADAT connection and ADATs #2 and #3 (i.e. tracks 9-24) should be connected to the ADAT connectors on the option board as appropriate.

You should connect the ADAT Sync connector to the machines - this will allow (amongst other things) the DPS24 to control the ADATs' transport.

The SYNC OUT of the DPS24 should be connected to SYNC IN on ADAT#1 and the SYNC OUT of ADAT#1 should be connected to the SYNC IN of ADAT#2 and, if there's a third ADAT, the SYNC OUT of ADAT#2 should be connected to the SYNC IN of ADAT#3.

You will note that the DPS24 is always a 'master' in this setup - it cannot be a slave and so only carries a SYNC OUT connector.

**NOTE:** EXT. SYNC must be switched ON for external machine control.  
 If EXT SYNC is not enabled, the DPS24 will not control the connected ADAT machines.

With the IB-24ADT option board installed, the extra ADAT channels ADAT 9-24 become available in addition to ADAT1-8.

ADAT inputs 9-24 are available as sources for Input Channels, Disk Record Sources and FX Return Sources, both in the PATCH / SOURCE page and in the MIXER / CHANNEL pages. Any of the 24 ADAT sources may also be routed directly to the STEREO OUTPUTS, the AUX OUTPUTS and the DIGITAL OUTPUTS in the PATCH / OUTPUTS page.

In the ADAT OUTPUT ASSIGN section of the PATCH / OUTPUTS page, you can now patch internal audio sources to any of the 24 ADAT outputs:

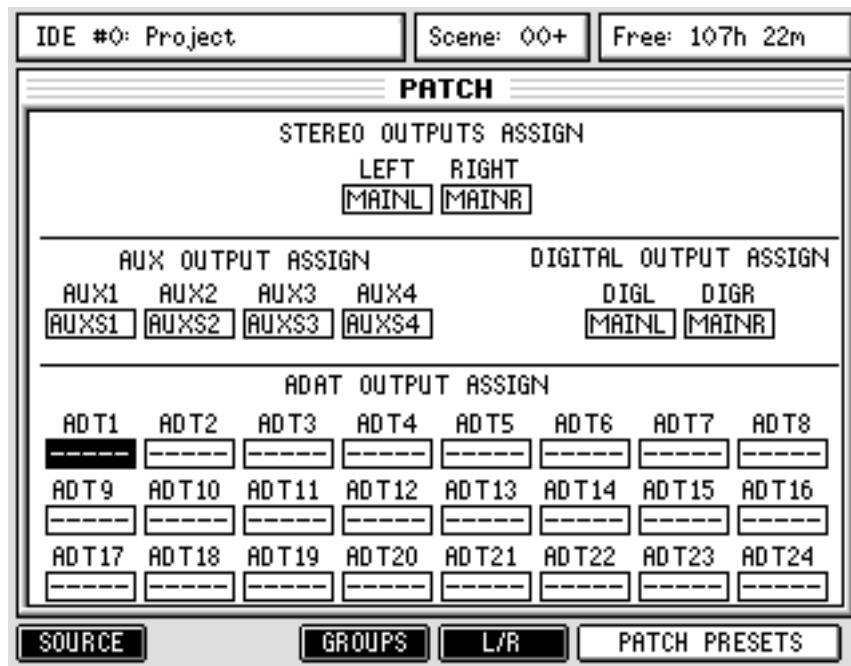

The available audio sources are:

Inputs 1-12	Solo L and R	FX1 L (FX 1 output L)
Tracks 1-24	FX Send Bus 1	FX1 R (FX 1 output R)
ADC 1-24	FX Send Bus 2	FX2 L (FX 2 output L)
DIGI L and R	FX Send Bus 3	FX2 R (FX 2 output R)
AUX IN L and R	FX Send Bus 4	FX3 L (FX 3 output L)
2-Track IN L and R	Aux Send Bus 1	FX3 R (FX 3 output R)
ADAT 1-24	Aux Send Bus 2	FX4 L (FX 4 output L)
Groups 1-8	Aux Send Bus 3	FX4 R (FX 4 output R)
Stereo L and R	Aux Send Bus 4	---- (No assignment)

With such routing flexibility, it is possible to use the PATCH pages as a digital audio patchbay between the DPS24 and your ADAT machine(s).

Also, if you need to get any of the ADAT sources to an analogue machine, don't forget that they can be assigned to the various analogue outputs on the DPS24 (the AUX OUTPUTS, for example).

Furthermore, if the ADAT SYNC OUT of the IB-24ADT is connected to the ADAT SYNC IN of an ADAT machine, the DPS24 automatically sends a DIGITAL INPUT : ON command to the ADAT so that all routing to the ADAT(s) can be done digitally. To get analogue signals to the ADAT(s), simply assign the DPS24's input channels and/or its ADCs to the various ADAT outputs.



## 24-TRACK TRANSFER - ADAT TO DPS24

Normally, the maximum number of audio sources the DPS24 can record simultaneously is 16.

In order to record 24 tracks simultaneously from the three sets of ADAT input connectors, the 24-TK RECORD parameter in the SETUP / PREFERENCES should be switched ON.

This sets the DPS24 up for recording on all 24 tracks to enable 24 track transfers from your ADATs to the DPS24.

**NOTE:** When 24 TK RECORD is enabled, tracks 21-24 cannot be used for playback. After performing a 24-track recording to the DPS24, you should switch 24 TK RECORD off in order to play the 24 tracks you have just transferred.

## 24-TRACK TRANSFERS - DPS24 TO ADAT

If you have three ADATs and want to transfer a 24-track project from the DPS24 to them, no special settings are required other than selecting the new patch preset shown above - this routes the 24 tracks of the DPS24 to their respective ADAT outputs 1-24. All you need do now is arm all 24 tracks on your ADAT machines and, when you're ready, press PLAY+REC on the DPS24 - the ADAT sync-link will control the transport of the external ADATs, dropping them in and out of record conveniently from the DPS24. Of course, when doing this, ensure that no tracks are selected for record on the DPS24!!

**NOTE:** For 24-track transfers to be made from the DPS24 to ADAT machines, it is essential that 24 TRK RECORD must be switched OFF otherwise only track 1-20 will play.

It may be worth pointing out that the DPS24's tracks are routed to the ADAT outputs post fader through the disk channels allowing you to transfer the audio with EQ, dynamics and level. Of course, if you simply want to transfer the audio 'raw' as it is on disk you simply turn off eq/dynamics, etc., on the tracks and set their faders to 0dB.

To assist with 24-track transfers, an additional "24 Track ADAT Transfer" Patch Preset is included which routes all 24 ADAT inputs directly to the Disk Record Sources for Tracks 1-24 on the DPS24.

This Patch Preset also routes the 24 tracks of the DPS24 to the 24 ADAT outputs.

## OTHER APPLICATIONS FOR THE ADAT EXPANSION OPTION

With the ADAT board installed, this opens up other possibilities for use with other ADAT equipped devices, not just ADAT machines.

For example, the DPS24 could accept transfers from other 24-track recorders or mixers equipped with ADAT format outputs.

Alternatively, you could use the DPS24 with other digital mixers, the only proviso being that they have at least 24 inputs and at least three ADAT inputs. In this way, you could, for example, build your tracks up at home and then use the DPS24 in a larger studio for mixdown with more outboard gear, etc..

Furthermore, you could use the ADAT I/Os to connect the DPS24 to a computer equipped with an ADAT I/O interface. Not only does this allow you to transfer tracks between the DPS24 and the computer (which can also be achieved using the extensive WAV/AIFF Import/Export features), but also allows to use the computer as a massive multi-effects processor for the DPS24, using off-the-shelf plug-ins.

With only the standard 8 channels of ADAT I/O, the DPS24 can send its master FX/AUX sends to the ADAT outputs and use the computer as global loop effects.

But with the IB-24ADT option board, the DPS24 can send simultaneously its 24 tracks to the computer for individual track processing.

In any case, effects returns from the computer via ADAT input can be assigned to the four stereo FX Return channels, and/or to any available input channel.

However, if you do plan to embark upon this, you must read the other equipment's documentation carefully to establish that what you want to do is technically and practically possible. There should be no problems - the ADAT interface is a well-known and popular one that is (or can be) fitted on many pieces of digital equipment - but please check carefully.

## ADAT AND DIGITAL CLOCK

When using the ADAT digital I/Os, it is critical to make sure that the digital clocks of the DPS24 and of the other ADAT units are locked, but it is also important to be careful not to create clock feedback loops. Incorrect clock setups will result in digital glitches or digital noise.

In normal operation of an ADAT system, with the ADAT SYNC OUT of the IB-24ADT connected to the ADAT SYNC IN of the ADAT system, the DPS24 Digital Sync parameter should be set to INTERNAL, as the DPS24 is the master of the system. In this configuration, the ADAT machines are locked together to the clock of the DPS24 via the ADAT SYNC connection.

If the ADAT SYNC connection is not used, it is possible to either lock the ADAT devices to the DPS24 master clock (DPS24 Digital Sync still set to INTERNAL) via the ADAT lightpipe (the ADAT devices should be set to clock from their optical input) or via Wordclock (the ADAT devices should be set to clock from their Wordclock input).

It is also possible for the DPS24 to slave its clock from one of the ADAT optical inputs.

When the IB-24ADT board is installed, two additional options are available for the Digital Sync parameter in SETUP mode: "ADAT 9..16" and "ADAT17..24", in addition to the "ADAT 1..8" option. In this case, the selected ADAT clock source device should be set to its internal clock and the other units should be locked to the master ADAT unit.

Finally, it is possible to clock the entire system from an external Master Clock unit (Sync/Clock Generator/distributor), typically via WordClock. In this case both the DPS24 and the ADAT devices should be set to WORDCLOCK digital sync.

At no point should the DPS24 and the ADAT system be both set to clock from their digital inputs at the same time. This would create a clock feedback loop (the DPS24 trying to sync to its digital input while the connected source is trying to sync to the digital output of the DPS24).

# APPENDIX

## MIDI Implementation Chart

Model DPS24

Date: 02-09-05

Version: 2.0

Function		Transmitted	Recognized	Remarks
Basic channel	Default	X	X	
	Changed	X	X	
Mode	Default	X	X	
	Messages	X	X	
	Altered	*****		
Note Number:	True Voice	X *****	X	
Velocity	Note On	X	X	
	Note Off	X	X	
After Touch	Key	X	X	
	Channel	X	X	
Pitch Bend		X	X	
Control Change		O	X	
Program Change	Setting Range OFF, 1 ~ 16, OM	*****	X	
System Exclusive		O	O	MTC, MMC
System Common	: Song Position	O	X	
	: Song Select	X	X	
	: Tune	X	X	
System Real Time	: Clock	O (*1)	X	
	: Command	O		Continue, Stop, Start
Aux Messages	: Local On/Off	X	X	
	: All Notes Off	X	X	
	: Active Sense	X	X	
	: Reset	X	X	
Notes		(*1) SSP and CLOCK.		

Mode 1: OMNI ON, POLY

Mode 2: OMNI ON, MONO

O: Yes

Mode 3: OMNI OFF, POLY

Mode 4: OMNI OFF, MONO

X: No

Block Diagrams

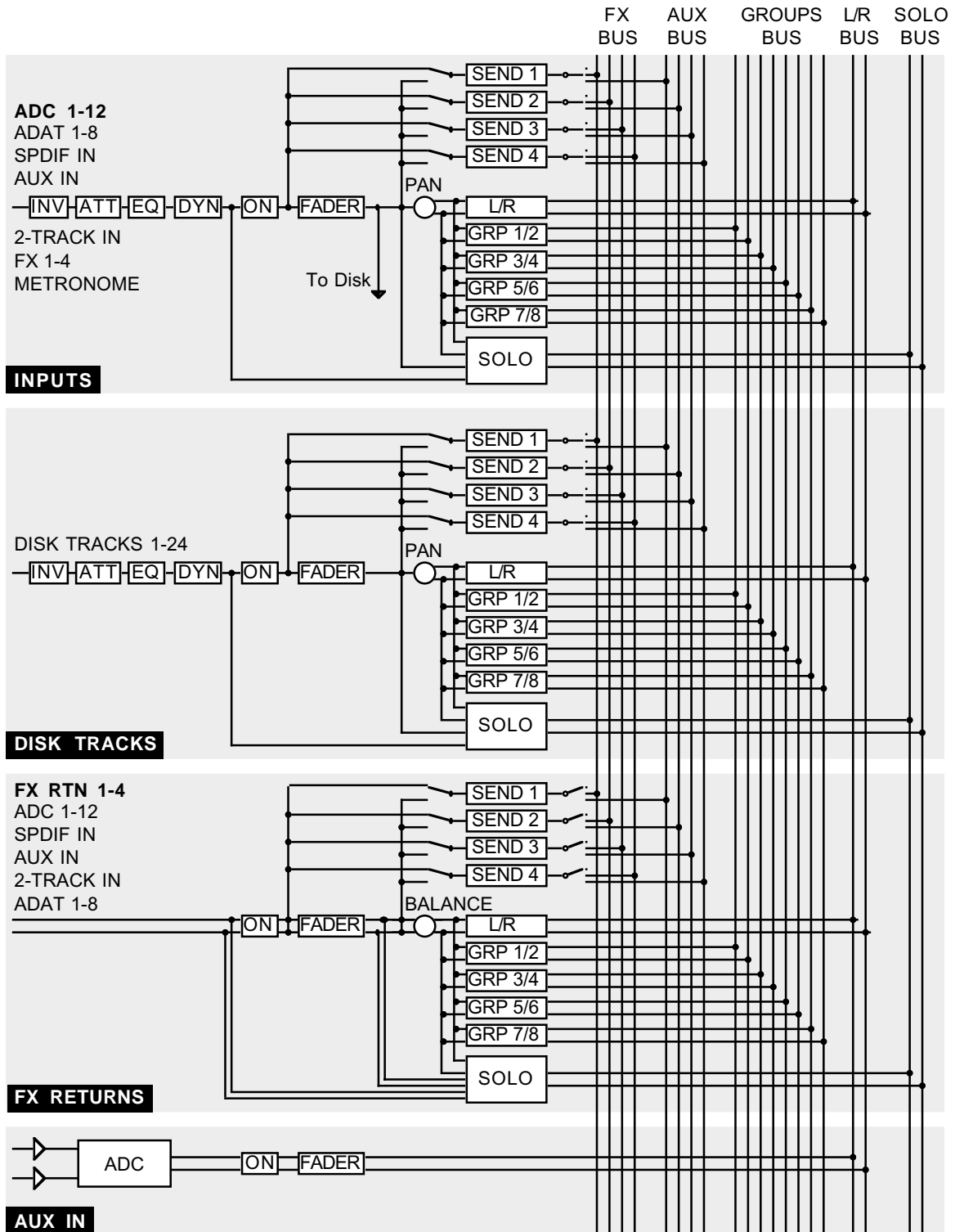

The default channel sources are shown in bold text.

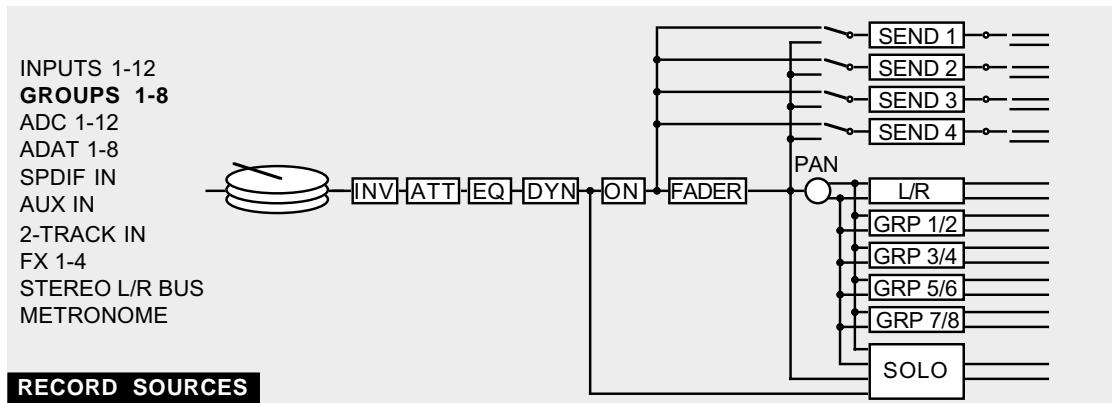

**RECORD SOURCES**

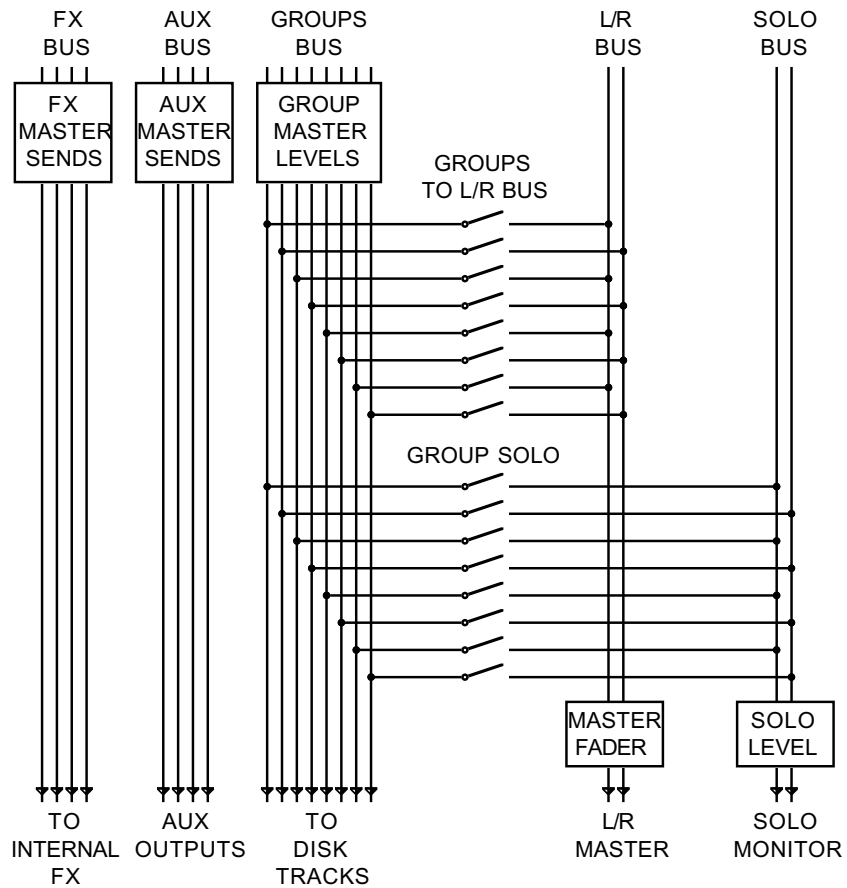

**BUSSES**

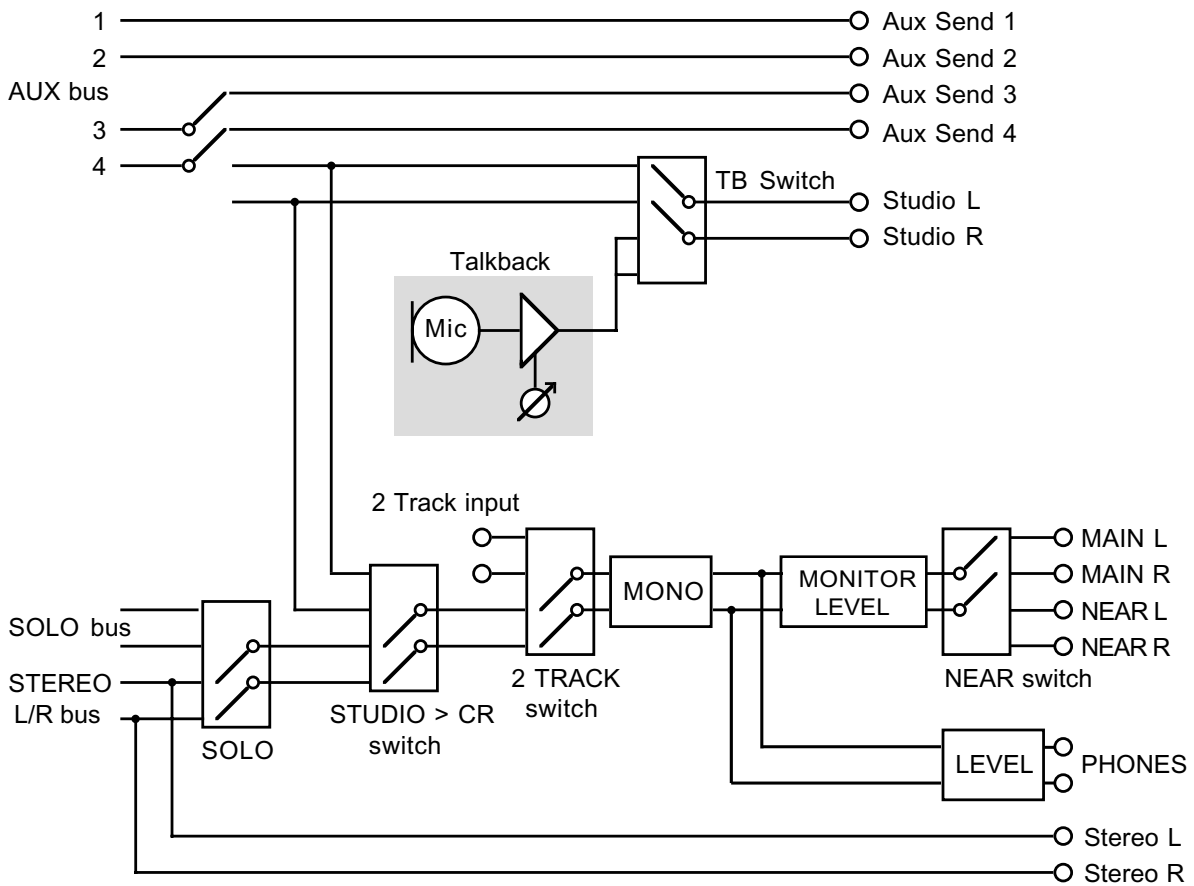

**OUTPUTS**

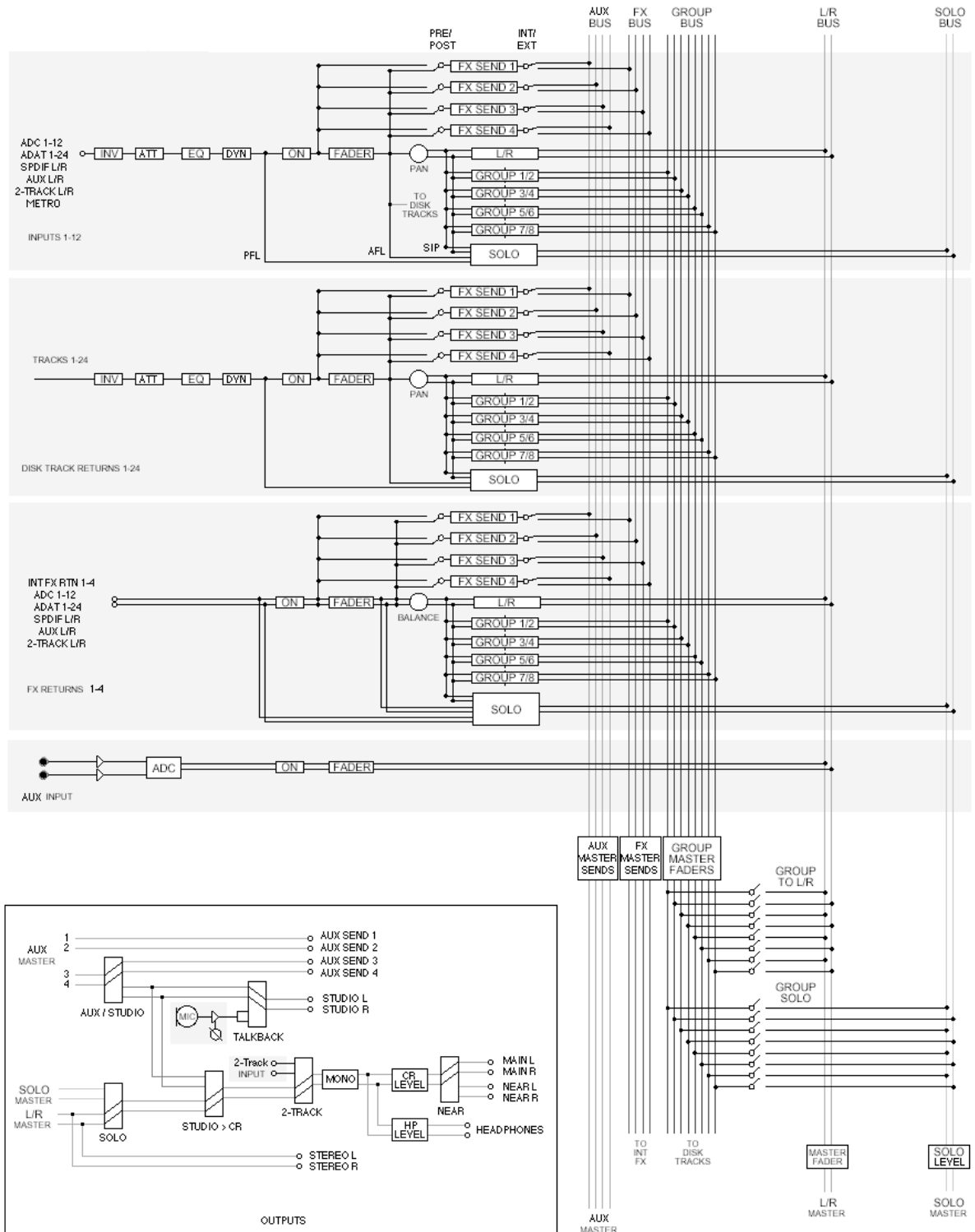

## Installation of Options - To Service Technicians

### IB-24LTC/IB-24ADT

1. Remove the screws for the cover of expansion slot and remove the cover. Save the screws.
2. Slide the Option Board in along the guide groove and press it firmly to ensure secure connection.

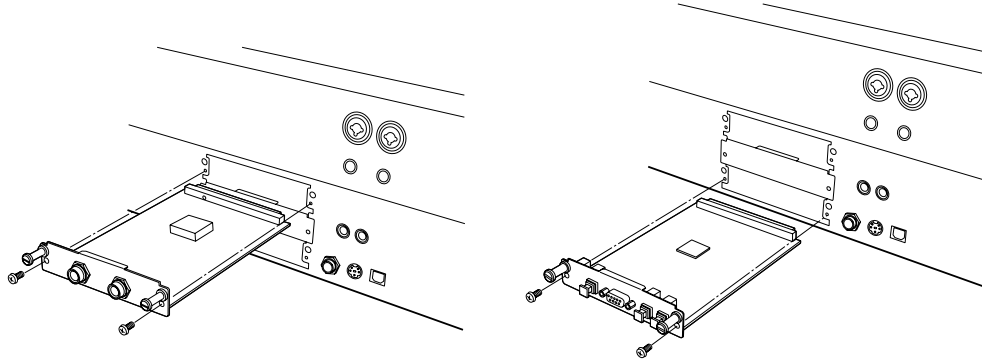

3. Tighten the screws back that have been removed in the previous step.

### IB-24SCSI

1. From the bottom of the unit, remove the screws for the bottom cover and open the bottom.

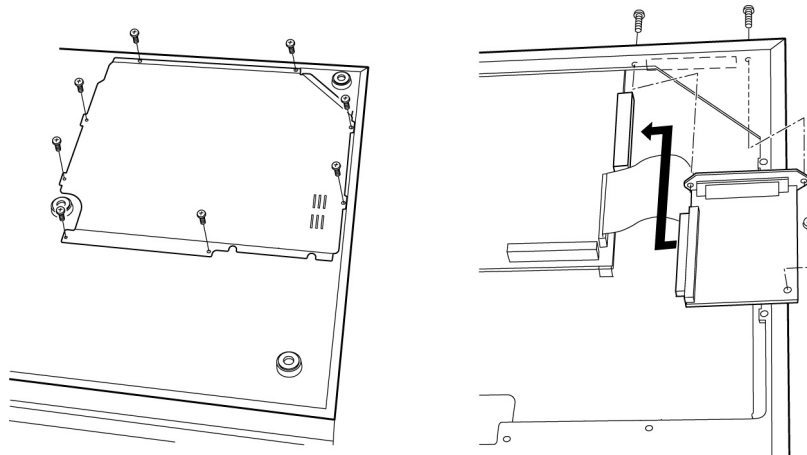

2. Remove the screws for the cover of SCSI option slot on the Rear Panel and remove the cover. Save the screws.
3. Place the board as illustrated, making sure that connectors are securely connected.
4. Mount the board with the screw included in the option board and with those screws removed previously.
5. Place the bottom cover back and tighten all screws.



## DPS24 OS Upgrade via USB (PC only)

You can check the current O/S Version in the SETUP page.

- 1) From akaipro.com Operating System Download page, download:
  - the latest OS Version (dps24\*\*\*.zip)
  - the OS Loader utility (dpsosldr.zip) if you haven't already installed it.
- 2) Create a new folder on your PC in a location that you will remember!  
For instance, create a folder named "Akai DPS24" in "My Documents".
- 3) Unzip the downloaded files into the folder created above.  
(If WinZip is not installed on your computer, you can get it from [www.winzip.com](http://www.winzip.com))  
After unzipping, the "AKAI DPS24" folder should contain the following files:

- DPS24USB.sys
- DPS24USB.inf
- usbrom.exe
- dps24.bin

(the .sys/.inf/.exe/.bin extensions might not be displayed on your computer)

- 4) Connect a good shielded USB cable between the DPS24 and your PC  
If the DPS24 USB driver is already installed on your PC, skip to Step 5.

If you have never connected the DPS24 to the PC before, you should get a "New Hardware found" message and Windows should automatically launch the "Hardware Wizard" utility.

If the Hardware Wizard does not open, right-click on "My Computer", and select "Properties".  
In System Properties, select the "Hardware" tab.

Click on "Device Manager".

In the list of devices, you should see "AKAI Digital Personal Studios".

Click on the "+" in front of that. This should show "AKAI DPS24 24-Track Personal Studio".

Right-click on that and select "Update Driver". This will launch the "Hardware Wizard" utility.

In the Hardware Wizard, select "Install from a list or specific location (advanced)" and click NEXT.

In the next window, select "Don't search. I will choose the driver to install" and click NEXT.

In the next window, click on "Have Disk".

In the Install from Disk window, click on "Browse" and locate the DPS24USB file  
(for instance in Desktop/My Documents/Akai DPS24).

Select the DPS24USB file and click on "Open". Back in the Install from Disk window, click on "OK".

Back in the Hardware Wizard, click NEXT. The Wizard will now copy and install the drivers.

When Completed, click on "Finish".

If you had opened the Device Manager and System Properties windows, close them.

- 5) On the DPS24, press the SETUP key, and then F6 for OS.  
In the O/S Upgrade page, use Q2 to select Upgrade from: USB port and press F5 or F6 (UPGRADE).  
Read the warning message and press F6 (YES) if you are ready.  
The DPS24 now displays a "Ready to update Flash ROM" screen.

- 6) From the Windows Start menu, select Programs / Accessories / Command Prompt (Windows XP) or Programs / MS-DOS Prompt (Windows 98 )  
-> This will open the DOS prompt window
- 7) Open the "Akai DPS24" folder (created in step 2).  
In the "Akai DPS24" folder, click on the "usbrom" file and drag it into the DOS window.  
Click on the DOS prompt window and enter a Space.  
In the "Akai DPS24" folder, click on the "DPS24.BIN" file and drag it into the DOS window.  
Click on the DOS prompt window and press the Enter key.  
When the Prompt window displays:  
"This will reprogram the DPS24 FlashROM. Are you sure you want to continue? [Y/N]", type Y.  
The program will now update the DPS24 OS.  
\*\*\* DO NOT POWER-DOWN the DPS24 nor the computer until completed! \*\*\*  
When completed, the DPS24 displays \* Please reboot now \*.  
On the PC, close the DOS prompt window.
- 8) Reboot the DPS24.  
When it has finished booting up, press the SETUP key to check your OS Version.

## DPS24 OS Upgrade via CD

You can check the current O/S Version in the SETUP page.

- 1) Download the latest OS Version (dps24\*\*\*.zip) from akaipro.com
- 2) Unzip the downloaded file  
  
If your computer does not already have an UnZip utility:
  - For Windows computers, use WinZip ([www.winzip.com](http://www.winzip.com))
  - For Mac computers, use ZipIt ([www.maczipit.com](http://www.maczipit.com))-> The unzipped file is called DPS24.BIN
- 3) Write the unzipped file to an ISO-9660 CD-R/RW disk
  - On Windows computers, ISO-9660 is the standard Data CD format
  - On Mac computers, make sure to select ISO-9660 Data CD (not Macintosh CD)
- 4) Insert the CD in the DPS24
- 5) In the CD-R SETUP page (SHIFT + SETUP), wait until Disc Status shows: DATA CD
- 6) In the SETUP page, press F6 (OS) to access the OS UPGRADE page
- 7) Use Q1 to select Upgrade from: CD
- 8) Press F5 or F6 (UPGRADE)  
-> The DPS24 will search the CD for the Operating System file
- 9) At the "Update Operating System to V\*.\*\*?" prompt, press F6 (YES)  
\*\*\* DO NOT SWITCH POWER OFF DURING SOFTWARE UPGRADE \*\*\*
- 10) When the DPS24 displays "Flash Programming Completed!", press F6 (OK) and reboot
- 11) After reboot, Check the O/S Version in the SETUP page.

## DPS24 ASCII Keyboard Commands

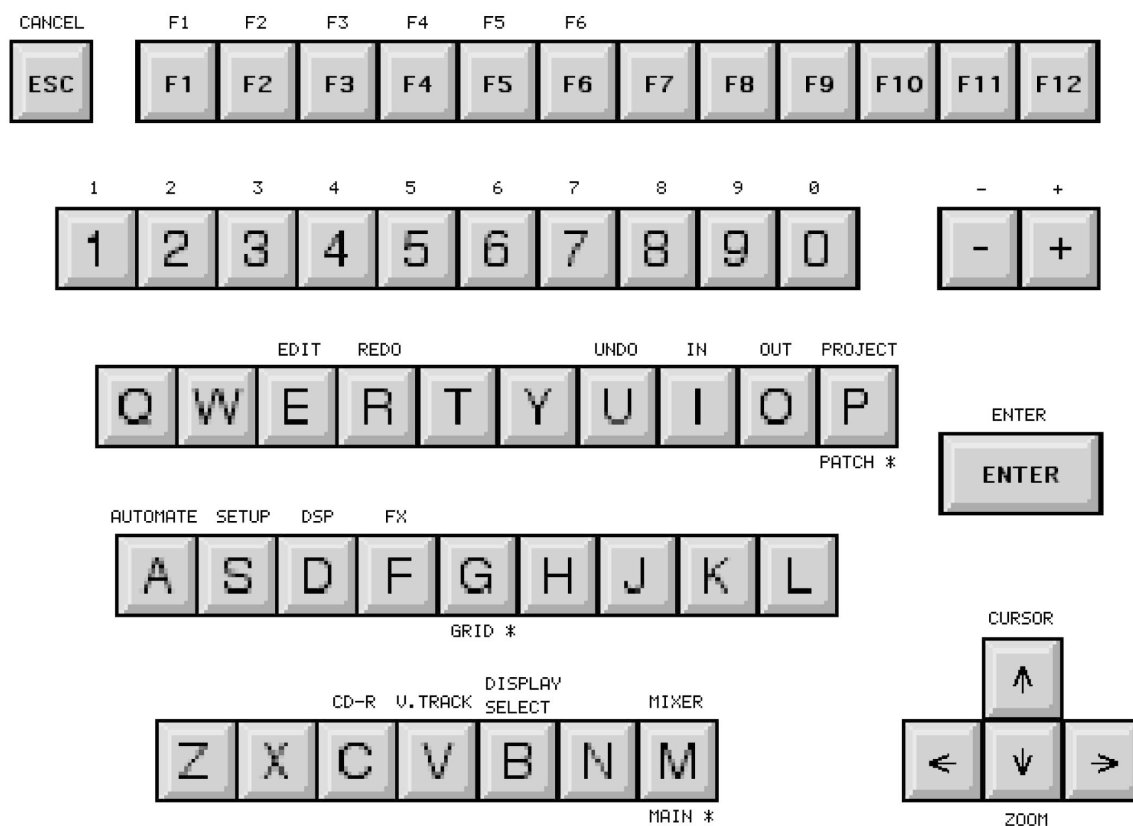

\* Most key functions use lowercase letters, except MAIN, GRID and PATCH, which use Uppercase letters

## DPS24 ADAT™ LRC Key Assignment

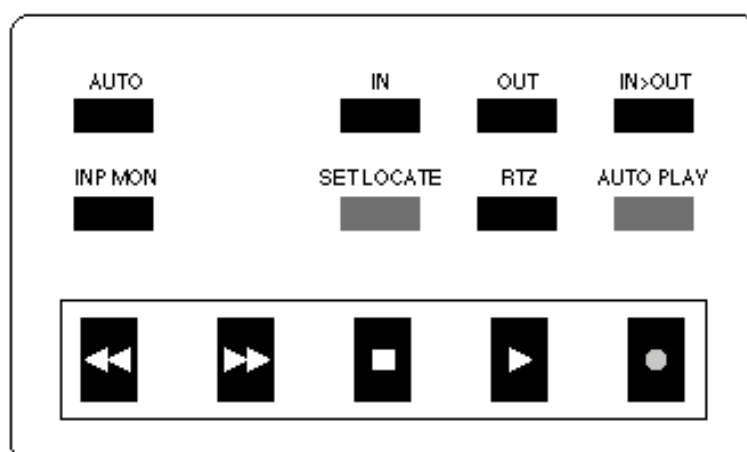

- Hold "SET LOCATE" and press "IN or OUT" to set In/Out points
- Press IN, OUT or RTZ to Goto In/Out points or Zero
- Hold AUTO PLAY and press IN, OUT or RTZ to Goto In/Out points or Zero and Play
- Press IN>OUT to Play from In to Out points
- Hold AUTO PLAY and press IN > OUT to enter LOOP play

# Specifications

Power Supply	AC 120V 60Hz (US, Canada), 220-240V 50Hz (Europe) 110W
Operating Temperature	10 - 35° C
Operating Humidity	10% - 60% (without condensation)
Dimensions (mm)	726 (W) x 190 (H) x 579 (D) max. (with LCD tilted down)
Weight	19.5kg
Display	320 x 240 dots STN graphic LCD with back light
Sampling Rate	96kHz, 48kHz, 44.1kHz, 32kHz
Quantization Bit	24 bit/16 bit Linear
Recording Media	Internal IDE Harddisk
Recording Time	With 10Gbyte Harddisk drive (24bit) FS=96kHz Approx. 9 hrs. 55 min. (12 tracks x 49 min. 45 sec.) FS=48kHz Approx. 19 hrs. 50 min. (24 tracks x 49 min. 45 sec.) FS=44.1kHz Approx. 21 hrs. 35 mi*n. (24 tracks x 54 min. 10 sec.) FS=32kHz Approx. 29 hrs. 50 min. (24 tracks x 1 hour 14 min.)
Frequency Response	FS=96kHz 10Hz - 44kHz +0/-2dB FS=48kHz 10Hz - 22kHz +0/-2dB FS=44.1kHz 10Hz - 20kHz +0/-2dB FS=32kHz 10Hz - 15kHz +0/-2dB
ADC	24bit 128-times oversampling, enhanced dual bit delta/sigma modulation
DAC	24bit 8-times oversampling, advanced segment delta/sigma modulation
Dynamic Range	104dB or more (30kHz LPF, FS=44.1kHz)
Distortion Ratio	0.003% or less (1kHz, 44.1kHz)
Channel Crosstalk	80dB or less (10kHz referenced, 100 ohms terminated)
Wow & Flutter	Below measurable level
Analog Audio Input	Inputs A 1 - 4ch     6.3mm Stereo Phone/XLR Combo Jack - balanced Phantom Power provided (switchable) for XLR connection 5 - 12ch    6.3mm Stereo Phone/XLR Combo Jack - balanced Inputs B 1 - 12ch    6.3mm Stereo Phone Jack - balanced Hi-Z 12ch        6.3mm Phone Jack - unbalanced ADC In     6.3mm Stereo Phone Jack - balanced AUX In     6.3mm Stereo Phone Jack - balanced 2-Track    RCA - unbalanced
Input Level	Mic mode     -62 - -2dBu (+16dBu max. balanced, 1kHz) Line mode    -47 - +13dBu (+31dBu max. balanced, 1kHz) Hi-Z           -68 - -8dBu (+10dBu max. unbalanced, 1kHz) ADC In        +4dBu (+22dBu max. balanced, 1kHz) AUX In        +4dBu (+22dBu max. balanced, 1kHz) 2-Track       -14dBu (+4dBu max. unbalanced, 1kHz)

Impedance	Mic mode	3k ohms (1 - 12ch)
	Line mode	12k ohms (1 - 12ch)
	Hi-Z	1M ohms
	ADC In	10k ohms
	AUX In	10k ohms
	2-Track	15k ohms
Analog Audio Output	Stereo Out	6.3mm Stereo Phone - balanced
	Main (monitor)	6.3mm Stereo Phone - balanced
	Nearfield (monitor)	6.3mm Stereo Phone - balanced
	Studio Out	6.3mm Stereo Phone - balanced
	Direct Out	6.3mm Stereo Phone - balanced
	AUX Sends 1 - 4	6.3mm Stereo Phone - balanced
Output Level	Stereo Out	+4dBu (+22dBu balanced max., 20k ohms load)
	Main (monitor)	+4dBu (+22dBu balanced max., 20k ohms load)
	Nearfield (monitor)	+4dBu (+22dBu balanced max., 20k ohms load)
	Studio Out	+4dBu (+22dBu balanced max., 20k ohms load)
	Direct Out	+4dBu (+22dBu balanced max., 20k ohms load)
	AUX Sends 1 - 4	+4dBu (+22dBu balanced max., 20k ohms load)
Impedance	Stereo Out	1k ohms - balanced
	Main (monitor)	1k ohms - balanced
	Nearfield (monitor)	1k ohms - balanced
	Studio Out	1k ohms - balanced
	Direct Out	1k ohms - balanced
	AUX Sends 1 - 4	1k ohms - balanced
Stereo Phones Output	x 2, 6.3mm Stereo Phone Jack - adjustable	
	Max. Output 155mW/32 ohms	
	Digital Audio Input x 1, RCA (SPDIF) 2-channels assignable	
	x 1, MP Light Pipe (adat/SPDIF) 8-channels/2-channel assignable	
	Digital Audio Output x 1, RCA (SPDIF) Master Output	
	x 1, MP Light Pipe (adat/SPDIF) 8-channels assignable/Master Output	
Wordclock	x 1, BNC - In/Out	
Foot switch	x 1, 6.3mm Phone Jack	
MIDI	x 3, 5 pin DIN - IN, OUT, THRU	
ASCII Keyboard	x 1, 6 pin Mini-DIN	
Accessories	3-prong Power Cable	
	Operator's Manual	
Options	IB-24LTC - SMPTE/EBU LTC Interface Board	
	IB-24ADT - 16-channel adat Interface Board w/adat Sync	
	IB-24SCSI - SCSI Interface Board	

\*0dBu = 0.775Vrms

The specifications are subject to change without prior notice.



**AKAI professional M.I. Corp.**